



Industrial Automation Headquarters

Delta Electronics, Inc.
Taoyuan Technology Center
18 Xinglong Road, Taoyuan District,
Taoyuan City 33068, Taiwan (R.O.C.)
TEL: 886-3-362-6301 / FAX: 886-3-371-6301

Asia

Delta Electronics (Shanghai) Co., Ltd
No.182 Minyu Road, Pudong Shanghai,
People's Republic of China
Post code : 201209
TEL: 86-21-68723988 / FAX: 86-21-6872-3996
Customer Service: 400-820-9595

Delta Electronics (Japan), Inc.
Tokyo Office
2-1-14 Minato-ku Shibadaimon,
Tokyo 105-0012, Japan
TEL: 81-3-5733-1111 / FAX: 81-3-5733-1211

Delta Electronics (Korea), Inc.
1511, Byucksan Digital Valley 6-cha, Gasan-dong,
Geumcheon-gu, Seoul, Korea, 153-704
TEL: 82-2-515-5303 / FAX: 82-2-515-5302

Delta Electronics Int'l (S) Pte Ltd.
4 Kaki Bukit Ave 1, #05-05, Singapore 417939
TEL: 65-6747-5155 / FAX: 65-6744-9228

Delta Electronics (India) Pvt. Ltd.
Plot No 43 Sector 35, HSIIDC
Gurgaon, PIN 122001, Haryana, India
TEL: 91-124-4874900 / FAX : 91-124-4874945

Delta Electronics (Thailand) Public Company Limited
909 Soi 9, Moo 4, Bangpoo Industrial
Estate(Epz) Pattana 1rd., Tambol Phraksa
Amphur Muang, Samutprakarn 10280 Thailand
TEL: 66(0)2-709-2800

Delta Energy Systems Austral Pty Ltd.
Unit 20-21, 45 Normanby rd, Notting Hill Vic 3168, Australia
TEL: 61-3-9543-3720

Americas

Delta Products Corporation (USA)
Raleigh Office
P.O. Box 12173, 5101 Davis Drive,
Research Triangle Park, NC 27709, U.S.A.
TEL: 1-919-767-3800 / FAX: 1-919-767-3969

Delta Greentech (Brasil) S.A.
Sao Paulo Office
Rua Itapeva, 26 - 3° andar Edificio Itapeva One-Bela Vista
01332-000-São Paulo-SP-Brazil
TEL: 55-11-3568-3855 / FAX: 55-11-3568-3865

Delta Electronics Int. Mexico
Mexico Office
Via Dr. Gustavo Baz 2160, La Loma
C.P. 54060, Estado de México
TEL: 55-2628-3015

*We reserve the right to change the information in this manual without prior notice.

DELTA_IA-MDS_VFD-CFP2000_UM_EN_20171115

EMEA

Delta Electronics (Netherlands) B.V.
Eindhoven Office
De Witbogt 20, 5652 AG Eindhoven, The Netherlands
TEL: 31 (0) 40-8003800 / FAX: 31 (0) 40-8003898
MAIL: Sales.IA.EMEA@deltaww.com
MAIL: Sales.IA.Benelux@deltaww.com

Delta Energy Systems (France) S.A
ZI du bois Chaland 2 15 rue des Pyrénées,
Lisses 91056 Evry Cedex
MAIL: Sales.IA.France@deltaww.com

Delta Energy Systems (Spain) S.L.
Ctra. De Villaverde a Vallecas, 265 1º Dcha Ed.
Hormigueras – P.I. de Vallecas 28031 Madrid
C/Llul, 321-329 (Edif. CINC) | 22@Barcelona | 08019 Barcelona
MAIL: Sales.IA.Iberia@deltaww.com

Delta Energy Systems Srl (Italy)
Via Senigallia 18/2 – 20161 Milano (MI)
Piazza Grazioli 18 – 00186 ROMA
MAIL: Sales.IA.Italy@deltaww.com

Delta Energy Systems (Germany) GmbH
Coesterweg 45, D-59494 Soest
MAIL: Sales.IA.DACH@deltaww.com

Delta Energy Systems LLC (CIS)
Vereyskaya Plaza II, office 112 Vereyskaya str.
17 121357 Moscow
MAIL: Sales.IA.RU@deltaww.com

Delta Greentech Ltd. (Turkiye)
Şerifali Mevkii Barbaros Bulvarı Söyleşi Sokak
No:19 K:1 Yukari Dudullu 34775 Ümraniye
İstanbul Sarigazi V.D 2740624765
MAIL: Sales.IA.Turkey@delta-emea.com

Delta Energy Systems (AG Dubai BR)
P.O. Box 185668, Gate 7, 3rd Floor, Hamarain Centre,
Dubai, United Arab Emirates
MAIL: Sales.IA.MEA@deltaww.com

Delta Fan and Pump Drive CFP2000 Series User Manual



Delta Fan and Pump Drive CFP2000 Series User Manual



www.deltaww.com



PLEASE READ PRIOR TO INSTALLATION FOR SAFETY.



- ☑ AC input power must be disconnected before any wiring to the AC motor drive is made.
- ☑ Even if the power has been turned off, a charge may still remain in the DC-link capacitors with hazardous voltages before the POWER LED is OFF. Please do not touch the internal circuit and components.
- ☑ There are highly sensitive MOS components on the printed circuit boards. These components are especially sensitive to static electricity. Please do not touch these components or the circuit boards before taking anti-static measures.
- ☑ Never reassemble internal components or wiring.
- ☑ Ground the AC motor drive using the ground terminal. The grounding method must comply with the laws of the country where the AC motor drive is to be installed.
- ☑ DO NOT install the AC motor drive in a place subjected to high temperature, direct sunlight and inflammables.



- ☑ Never connect the AC motor drive output terminals U/T1, V/T2 and W/T3 directly to the AC mains circuit power supply.
- ☑ The rated voltage of the AC motor drive must be $\leq 240V$ for 230 series, and $\leq 480V$ for 460 series and the current should be less than 5000A RMS (40HP (30kW) should be less than 10000A RMS).
- ☑ Only qualified persons are allowed to install, wire and maintain the AC motor drives.
- ☑ Even if the 3-phase AC motor is stop, a charge may still remain in the main circuit terminals of the AC motor drive with hazardous voltages.
- ☑ The performance of electrolytic capacitor will degrade if it is not charged for a long time. It is recommended to charge the drive which is stored in no charge condition every 2 years for 3~4 hours to restore the performance of electrolytic capacitor in the motor drive. Note: When power up the motor drive, use adjustable AC power source (ex. AC autotransformer) to charge the drive at 70%~80% of rated voltage for 30 minutes (do not run the motor drive). Then charge the drive at 100% of rated voltage for an hour (do not run the motor drive). By doing these, restore the performance of electrolytic capacitor before starting to run the motor drive. Do NOT run the motor drive at 100% rated voltage right away.
- ☑ Pay attention to the following when transporting and installing this package (including wooden crate, wood stave and carton box)
 1. If you need to sterilize, deworm the wooden crate or carton box, please do not use steamed smoking sterilization or you will damage the VFD. The warranty does not cover VFD damaged by steamed smoking sterilization.
 2. Please use other ways to sterilize or deworm.
 3. You may use high temperature to sterilize or deworm. Leave the packaging materials in an environment of over $56^{\circ}C$ for 30 minutes.
 4. It is strictly forbidden to use steamed smoking sterilization.

- ☑ Connect the drive to a 3-phase three-wire or 3-phase four-wire Wye system to comply with UL standards.
- ☑ Since the leakage current of the motor drive is higher than 3.5 mA a.c. or 10 mA d.c., the end users are advised to follow at least one of the procedures below to avoid electric shock:
 1. Connect the motor drive to the ground by using a copper wire with a sectional area of 10 mm² minimum or an aluminum wire with a sectional are of 16 mm² minimum.
 2. Install an electricity leakage breaker.

 **NOTE**

- For a detailed explanation of the product specifications, the cover or the safety shields will be disassembled on some pictures or graphics. When the product is put to operation, please install the top cover and safety shield and ensure correct wiring. Refer to the manual to ensure safe operation.
- The figures in this instruction are for reference only, they may be slightly different from your actual drive, but it will not affect your customer rights.
- The content of this manual may be revised without prior notice. Please consult our distributors or download the latest version at <http://www.delta.com.tw/industrialautomation>

Table of Contents

CHAPTER 1 INTRODUCTION	1-1
1-1 Nameplate Information.....	1-2
1-2 Model Name.....	1-3
1-3 Serial Number.....	1-3
1-4 Apply After Service by Mobile Device.....	1-4
1-5 RFI Jumper.....	1-5
1-6 Dimensions.....	1-13
1-7 Digital Keypad.....	1-28
CHAPTER 2 INSTALLATION	2-1
CHAPTER 3 UNPACKING	3-1
3-1 Unpacking.....	3-2
3-2 The Lifting Hook.....	3-6
CHAPTER 4 WIRING	4-1
4-1 System Wiring Diagram.....	4-3
4-2 Wiring.....	4-4
4-3 Wiring Plate Diagram.....	4-7
4-4 Basic Waterproof Component Wiring Diagram.....	4-8
CHAPTER 5 MAIN CIRCUIT TERMINALS	5-1
5-1 Main Circuit Diagram.....	5-4
5-2 Main Circuit Terminals.....	5-5
CHPATER 6 CONTROL TERMINALS	6-1
6-1 Remove the Cover for Wiring.....	6-4
6-2 Specifications of Control Terminal.....	6-6
6-3 Remove the Terminal Block.....	6-9
CHAPTER 7 OPTIONAL ACCESSORIES	7-1
7-1 Brake Resistors and Brake Units Selection Chart.....	7-2
7-2 Non-fuse Circuit Breaker.....	7-8
7-3 Fuse Specification Chart	7-9
7-4 AC Reactor.....	7-10
7-5 Zero Phase Reactors.....	7-15
7-6 EMC Filter.....	7-16
7-7 Panel Mounting.....	7-21

7-8 Fan Kit.....	7-23
7-9 USB/RS-485 Communication Interface IFD6530.....	7-35
CHAPTER 8 OPTION CARDS.....	8-1
8-1 Option Card Installation.....	8-2
8-2 EMC-D42A (I/O Extension Card).....	8-8
8-3 EMC-D611A (I/O Extension Card).....	8-8
8-4 EMC-R6AA (Relay Extension Card).....	8-8
8-5 EMC-BPS01 (24V Power Extension Card).....	8-9
8-6 CMC-MOD01 (Communication Extension Card).....	8-10
8-7 CMC-PD01(Communication Extension Card).....	8-13
8-8 CMC-DN01(Communication Extension Card).....	8-15
8-9 CMC-EIP01(Communication Extension Card).....	8-18
8-10 EMC-COP01(Communication Extension Card).....	8-22
8-11 Delta Standard Fieldbus Cables.....	8-23
CHAPTER 9 SPECIFICATION.....	9-1
9-1 460V Series.....	9-2
9-2 Environment for Operation, Storage and Transportation.....	9-4
9-3 Specifications for Operation Temperature and Protection Level.....	9-5
9-4 Derating of Ambient Temperature and Altitude.....	9-5
CHAPTER 10 DIGITAL KEYPAD	10-1
10-1 Descriptions of Digital Keypad	10-2
10-2 Function of Digital Keypad KPC-CC02.....	10-5
10-3 TPEditor Installation Instruction	10-27
10-4 Digital Keypad KPC-CC02 Fault Code and Description.....	10-35
10-5 Unsupported Functions when using TPEditor on KPC-CC02.....	10-39
CHAPTER 11 SUMMARY OF PARAMETERS.....	11-1
00 Drive Parameters.....	11-1
01 Basic Parameters.....	11-5
02 Digital Input/ Output Parameters.....	11-7
03 Analog Input/ Output Parameters.....	11-11
04 Multi-step Speed Parameters.....	11-14
05 Motor Parameters.....	11-15
06 Protection Parameters.....	11-17
07 Special Parameters.....	11-22
08 High-function PID Parameters.....	11-24
09 Communication Parameters.....	11-25
10 Speed Feedback Control Parameters.....	11-29

11 Advanced Parameters.....	11-30
12 Pump Parameters.....	11-31
13 Application Parameters by Industry.....	11-32
CHAPTER 12 DESCRIPTION OF PARAMETER SETTINGS	12-1
12-1 Description of Parameter Settings.....	12.1-00-1
00 Drive Parameters.....	12.1-00-1
01 Basic Parameters.....	12.1-01-1
02 Digital Input/ Output Parameters.....	12.1-02-1
03 Analog Input/ Output Parameters.....	12.1-03-1
04 Multi-step Speed Parameters.....	12.1-04-1
05 Motor Parameters.....	12.1-05-1
06 Protection Parameters.....	12.1-06-1
07 Special Parameters.....	12.1-07-1
08 High-function PID Parameters.....	12.1-08-1
09 Communication Parameters.....	12.1-09-1
10 Speed Feedback Control Parameters.....	12.1-10-1
11 Advanced Parameters.....	12.1-11-1
12 Pump Parameters.....	12.1-12-1
13 Application Parameters by Industry.....	12.1-13-1
12-1 Adjustment & Application.....	12.1-1
CHAPTER 13 WARNING CODES	13-1
CHAPTER 14 FAULT CODES AND DESCRIPTIONS.....	14-1
CHAPTER 15 CANOPEN OVERVIEW.....	15-1
15-1 CANopen Overview.....	15-3
15-2 Wiring of CANopen.....	15-6
15-3 CANopen Communication Interface Descriptions.....	15-7
15-4 CANopen Supporting Index.....	15-16
15-5 CANopen Fault Code.....	15-22
15-6 CANopen LED Function.....	15-30
CHAPTER 16 PLC FUNCTION	16-1
16-1 PLC Summary.....	16-2
16-2 Notes Before PLC Use.....	16-3
16-3 Turn On.....	16-5
16-4 Basic Principles of PLC Ladder Diagrams.....	16-14
16-5 Various PLC Device Functions.....	16-25
16-6 Introduction to The Command Window.....	16-38

16-7 Error Display and Handling.....16-116

16-8 CANopen Master Control Applications.....16-117

16-9 Explanation of Various PLC Speed Mode Controls.....16-129

16-10 Internal Communications Main Node Control.....16-131

16-11 Modbus Remote IO Control Applications (use MODRW).....16-135

16-12 Calendar Functions.....16-142

CHAPTER 17 INTRODUCTION TO BACnet.....17-1

CHAPTER 18 SAFE TORQUE OFF FUNCTION.....18-1

APPENDIX A. PUBLICATION HISTORY.....A-1

Application Control Board: V1.03
Keypad: V1.04

Chapter 1 Introduction

- 1-1** Nameplate Information
- 1-2** Model Name
- 1-3** Serial Number
- 1-4** Apply After Service by Mobile Device
- 1-5** RFI Jumper
- 1-6** Dimensions
- 1-7** Digital Keypad

Receiving and Inspection

After receiving the AC motor drive, please check for the following:

1. Please inspect the unit after unpacking to ensure it was not damaged during shipment. Make sure that the part number printed on the package corresponds with the part number indicated on the nameplate.
2. Make sure that the mains voltage is within the range as indicated on the nameplate. Please install the AC motor drive according to this manual.
3. Before applying the power, please make sure that all devices, including mains power, motor, control board and digital keypad, are connected correctly.
4. When wiring the AC motor drive, please make sure that the wiring of input terminals “R/L1, S/L2, T/L3” and output terminal “U/T1, V/T2, W/T3” are correct to prevent damage to the drive.
5. When power is applied, select the language and set parameters via the digital keypad (KPC-CC02). When executing a trial run, please begin with a low speed and then gradually increase the speed until the desired speed is reached.

1-1 Nameplate Information

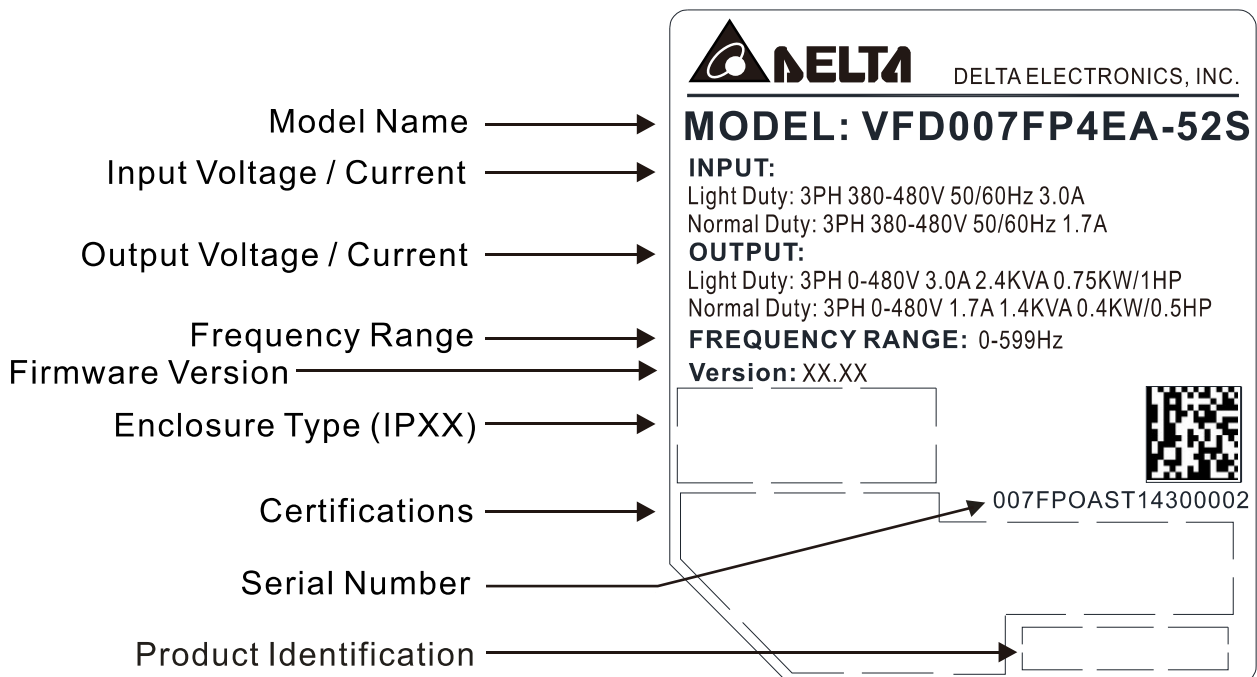

1-2 Model Name

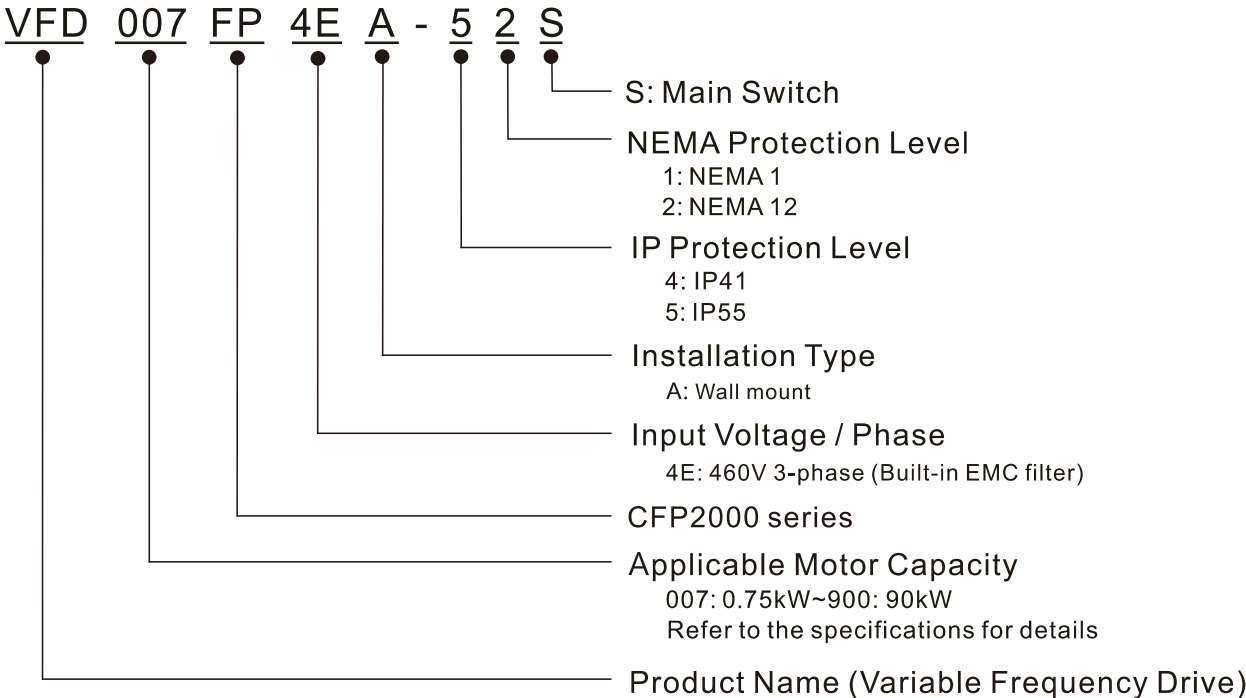

1-3 Serial Number

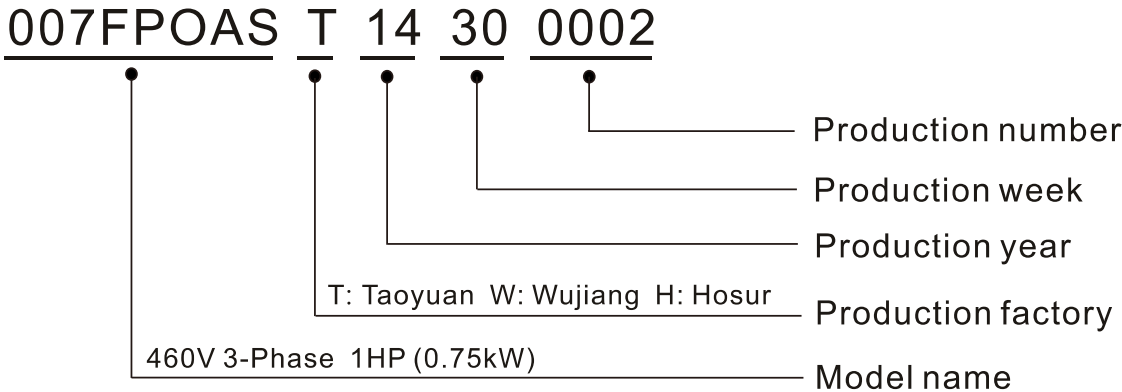

1-4 Apply After Service by Mobile Device

1-4-1 Location of Service Link Label

Frame A~D

Service link label (Service Label) will be pasted on the lower-left corner of the side where keypad is installed on the case body, as below drawing shown:

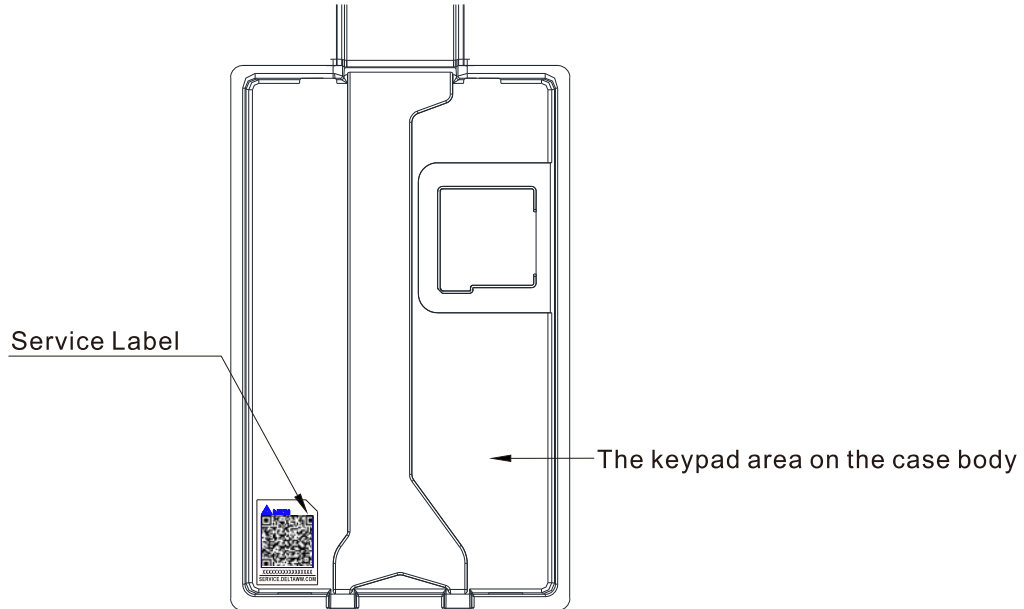

1-4-2 Service Link Label

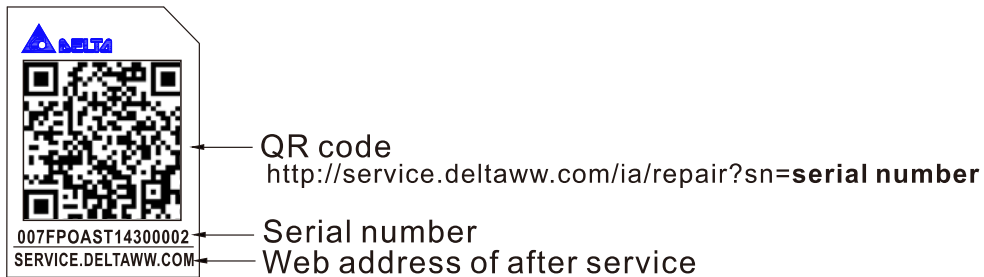

Scan QR Code to apply

1. Find out the QR code sticker (as above shown).
2. Use a Smartphone to run a QR Code reader APP.
3. Point your camera to the QR Code. Hold your camera steady so that the QR code comes into focus.
4. Access the Delta After Service website.
5. Fill your information into the column marked with an orange star.
6. Enter the CAPTCHA and click "Submit" to complete the application.

Cannot find out the QR Code?

1. Open a web browser on your computer or smart phone.
2. Key in <https://service.deltaww.com/ia/repair> in address bar and press enter.
3. Fill your information into the columns marked with an orange star.
4. Enter the CAPTCHA and click "Submit" to complete the application.

1-5 RFI Jumper

- (1) In the drive there are Varistor / MOVs, which are connected from phase to phase and from phase to ground, to protect the drive against mains surges or voltage spikes.
Because the Varistors / MOVs from phase to ground are connected to ground via the RFI jumper, the protection will be ineffective when the RFI jumper is removed.
- (2) In the models with built-in EMC filter the RFI jumper connects the filter capacitors to ground to form a return path for high frequency noise to isolate the noise from contaminating the mains power.
Removing the RFI jumper strongly reduces the effect of the built-in EMC filter.
- (3) Although a single drive complies with the international standards for leakage current, an installation with several drives with built-in EMC filter can trigger the RCD. Removing the RFI jumper helps, but the EMC performance of each drive would be no longer guaranteed.

Frame A

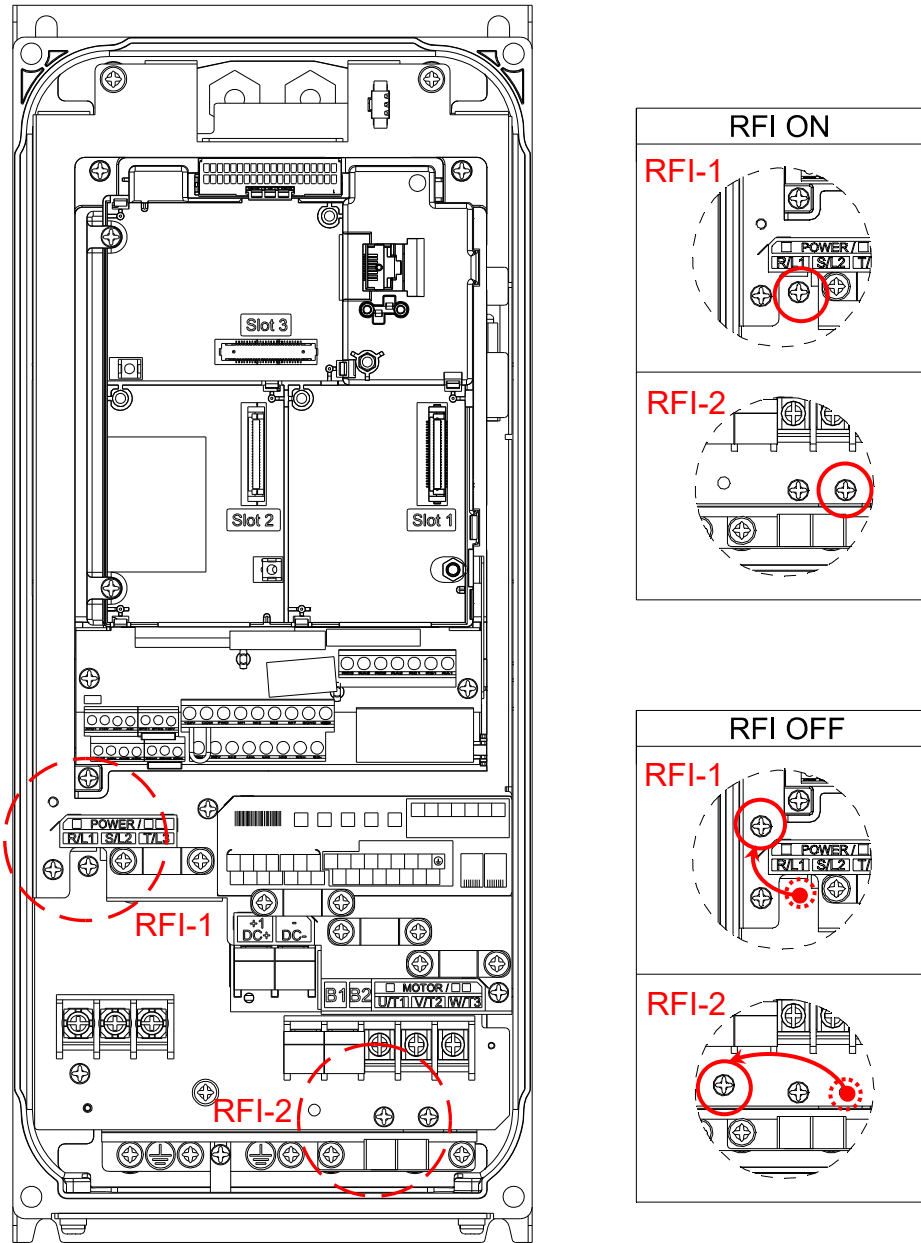

Frame B

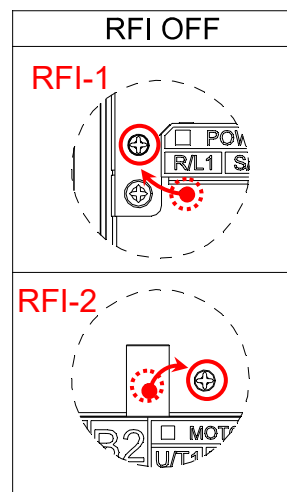
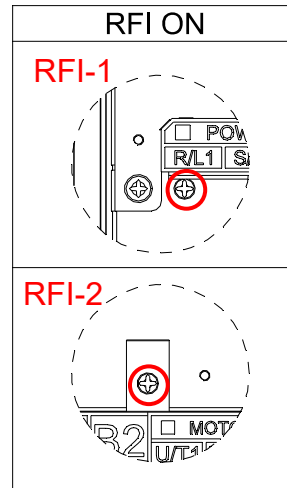
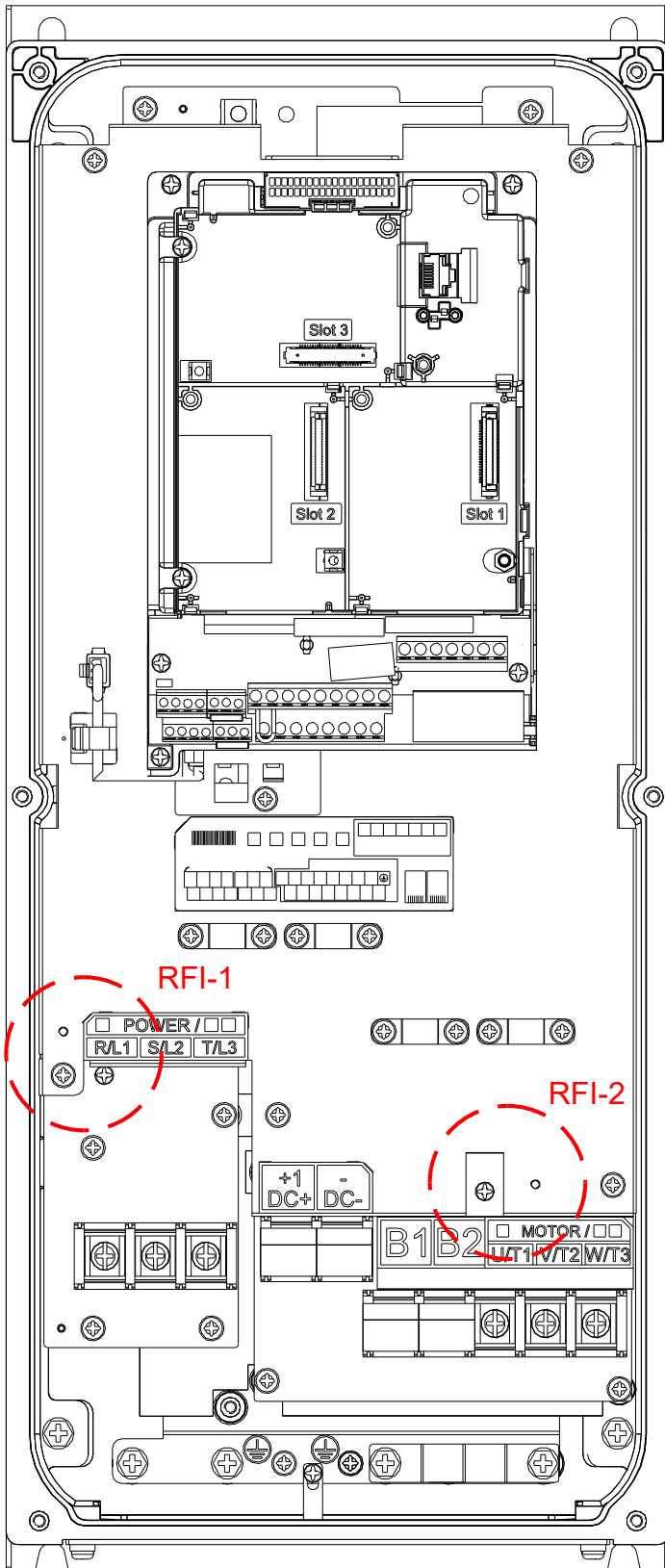

Frame C

By switching the position of the RFI jumper to control On/ Off.

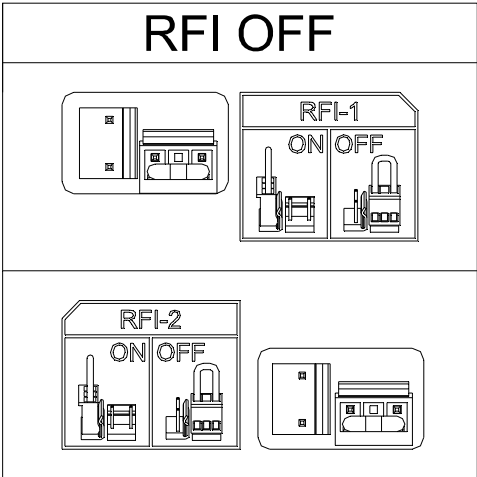
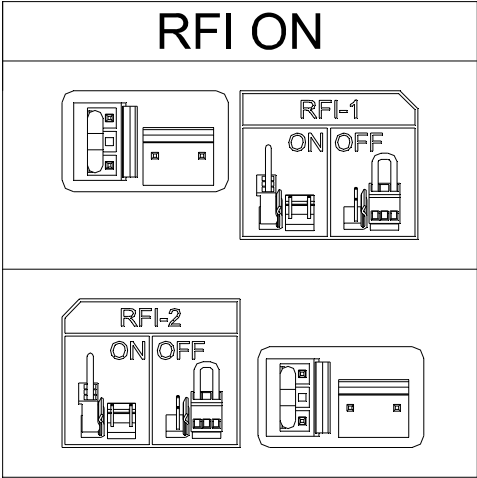
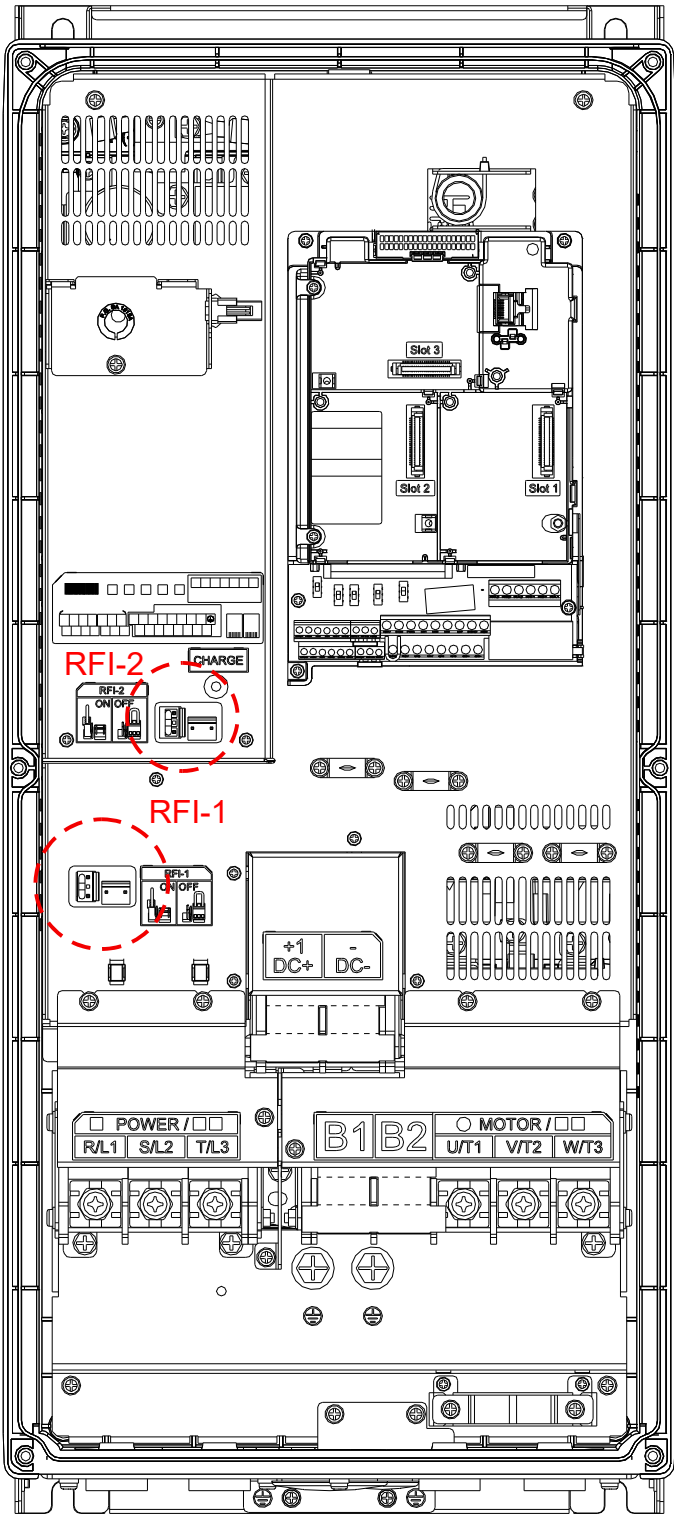

Frame D0

By switching the position of the RFI jumper to control On/ Off.

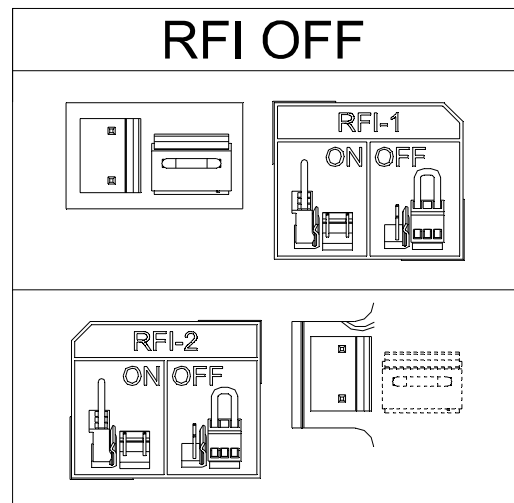
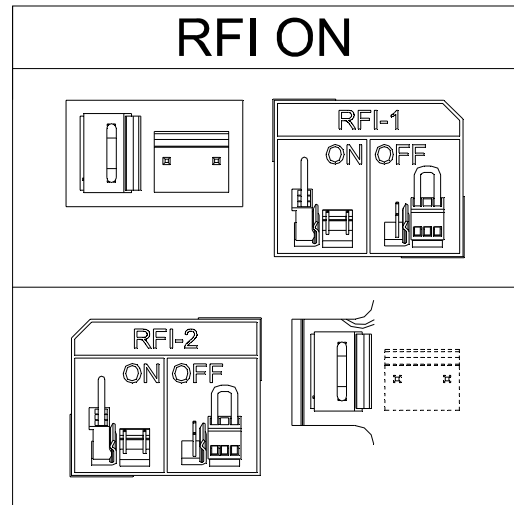
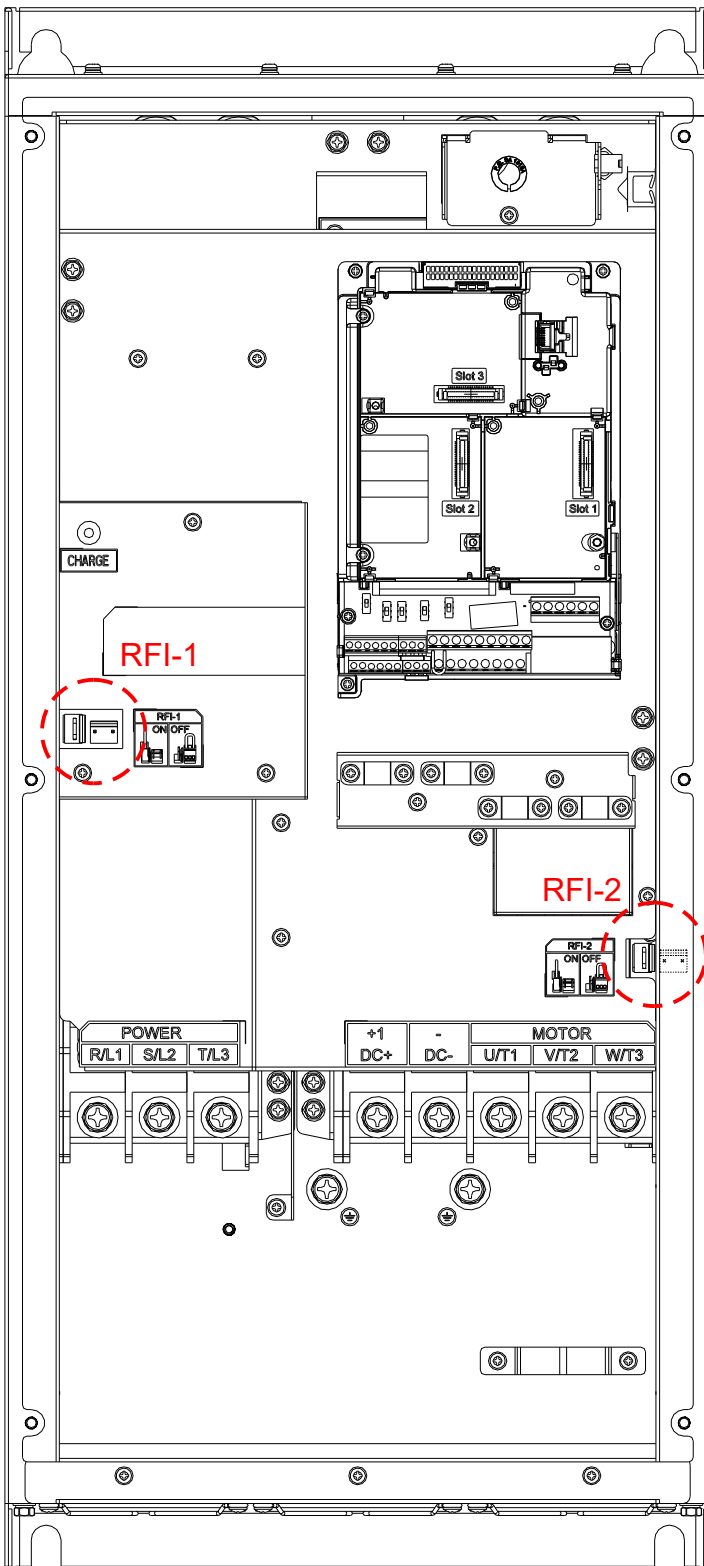

Frame D

By switching the position of the RFI jumper to control On/ Off.

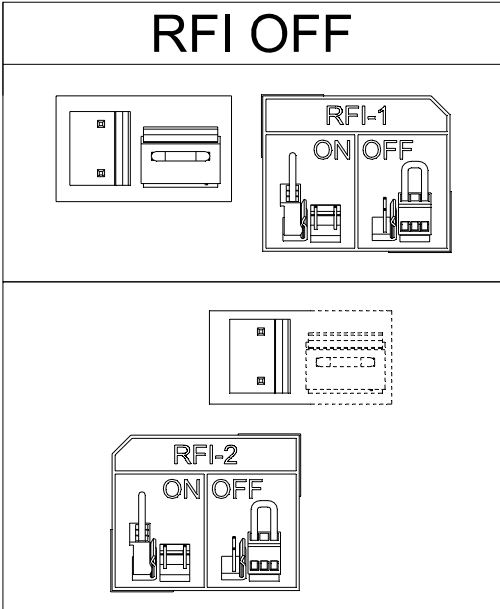
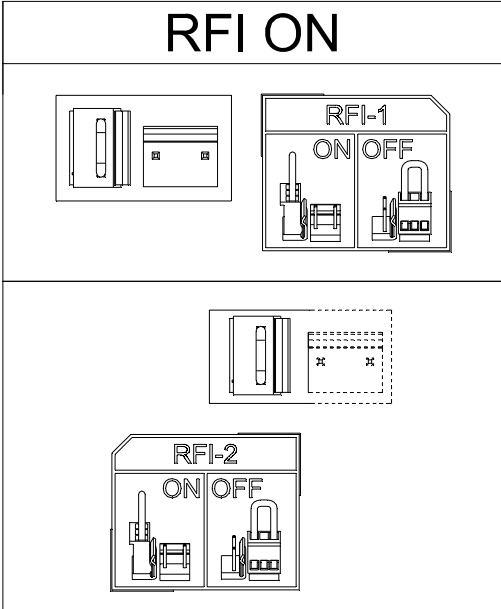
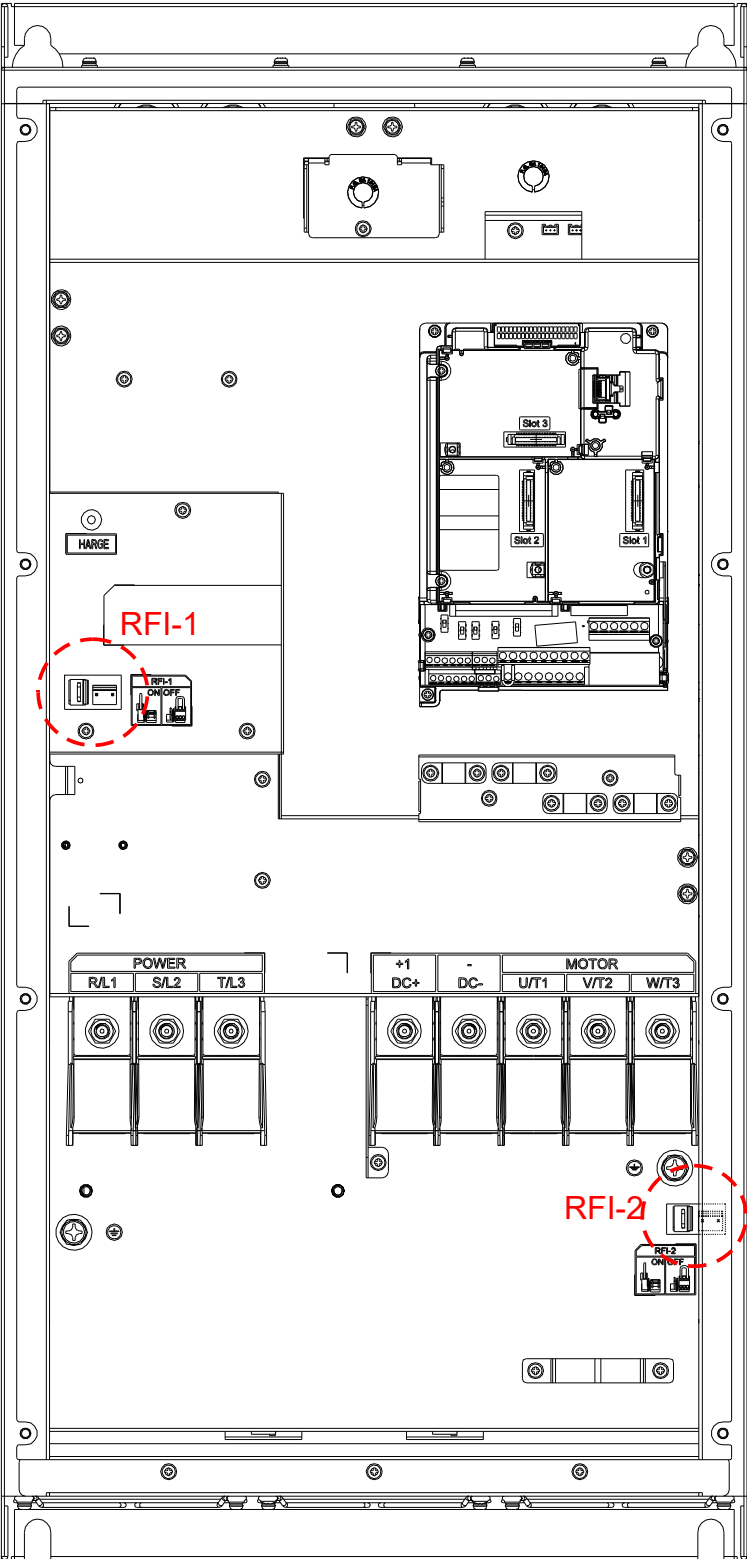

Remove the built-in EMC Filter:

In some specific power system, the shunt capacitors might cause damage on motor drive or electrically charge the enclosure to cause electrical shock. In view of the considerations above, here are the recommendations on jumper/ screw installation of three power systems:

Jumper/screw	TN-S System	TT System	IT System
RFI-1	Keep	Keep	Remove
RFI-2	Keep	Remove	Remove

Note1: If any of the RFI is removed, the EMC effect will be affected.

Note 2: Using a LCB (leakage circuit breaker) designed for motor drive is recommended. If a LCB has tripped, remove the RFI-2 (jumper/ screw) or contact an authorized dealer of Delta near you.

Note 3: Earthing Systems

The international standard IEC60364 distinguishes three different earthing system categories, using the two-letter codes TN, TT, IT.

The **first letter** indicates the type of earthing for the power supply equipment (generator or transformer).

T: One or more points of the power supply equipment are connected directly to the same earthing point.

I: Either no point is connected to earth (isolated) or it is connected to earth via a high impedance.

The **second letter** indicates the connection between earth and the power supply equipment.

T: Connected directly to earth (This earthing point is separated from other earthing points in the power supply system.)

N: Connected to earth via the conductor that is provided by the power supply system

Isolating main power from ground:

When the power distribution system of the drive is a floating ground system (IT) or an asymmetric ground system (TN), the RFI Jumper must be removed. Removing the RFI Jumper disconnects the internal capacitors from ground to avoid damaging the internal circuits and to reduce the ground leakage current.

Important points regarding ground connection:

- ☑ To ensure the safety of personnel, proper operation, and to reduce electromagnetic radiation, the drive must be properly grounded during installation.
- ☑ The diameter of the cables must comply with the local safety regulations.
- ☑ The shield of shielded cables must be connected to the ground of the drive to meet safety regulations.
- ☑ The shield of shielded power cables can only be used as the ground for equipment when the aforementioned points are met.
- ☑ When installing more drives, do not connect the grounds of the drives in series but connect each drive to ground.

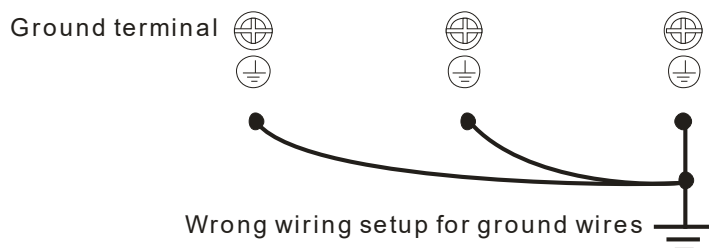

Pay particular attention to the following points:

- ☑ Do not remove the RFI jumper while the power is on.
- ☑ Removing the RFI jumper will also disconnect the built-in EMC filter capacitors. Compliance with the EMC specifications is no longer guaranteed.
- ☑ The RFI jumper may not be removed if the mains power is a grounded power system.
- ☑ The RFI jumper may not be removed while conducting high voltage tests. When conducting a high voltage test to the entire facility, the mains power and the motor must be disconnected if the leakage current is too high.

Floating Ground System(IT Systems)

A floating ground system is also called an IT system, an ungrounded system, or a high impedance/resistance (greater than 30 Ω) grounded system.

- ☑ Disconnect the RFI Jumper.
- ☑ Check whether there is excess electromagnetic radiation affecting nearby low-voltage circuits.
- ☑ In some situations, the transformer and cable naturally provide enough suppression. If in doubt, install an extra electrostatic shielded cable on the power supply side between the main circuit and the control terminals to increase security.
- ☑ Do not install an external EMC filter. The EMC filter is connected to ground through the filter capacitors, thus connecting power input to ground. This is very dangerous and can easily damage the drive.

Asymmetric Ground System(Corner Grounded TN Systems)

Caution: Do not remove the RFI jumper while the input terminal of the AC motor drive carries power. In the following four situations, the RFI jumper must be removed. This is to prevent the system from grounding through the RFI capacitor, damaging the AC motor drive.

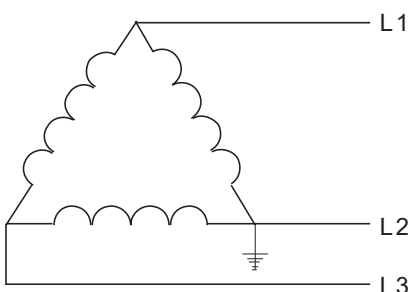
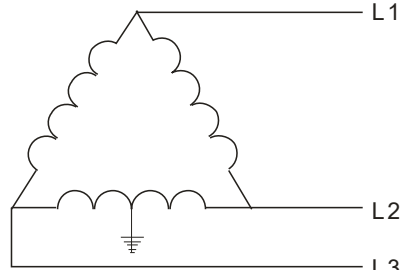
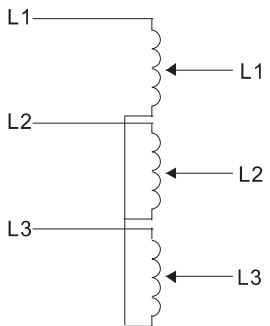
RFI jumper must be removed	
<p>1. Grounding at a corner in a triangle configuration</p> 	<p>2. Grounding at a midpoint in a polygonal configuration</p> 
<p>3. No stable neutral grounding in a three-phase autotransformer configuration</p> 	

RFI jumper can be used

Internal grounding through RFI capacitors, which reduce electromagnetic radiation. In a symmetrically grounding power system with higher EMC requirements, an EMC filter can be installed. As a reference, the diagram on the right is a symmetrical grounding power system.

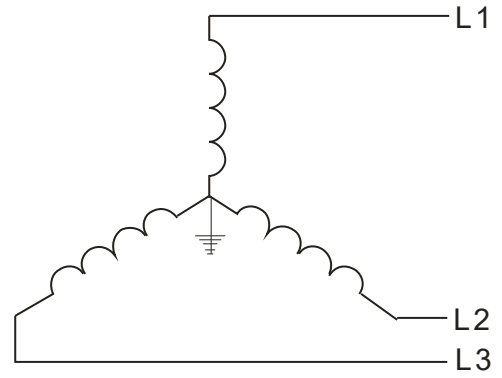

1-6 Dimensions

Frame A

A-1: VFD007FP4EA-52, VFD015FP4EA-52, VFD022FP4EA-52, VFD037FP4EA-52, VFD040FP4EA-52, VFD055FP4EA-52, VFD075FP4EA-52

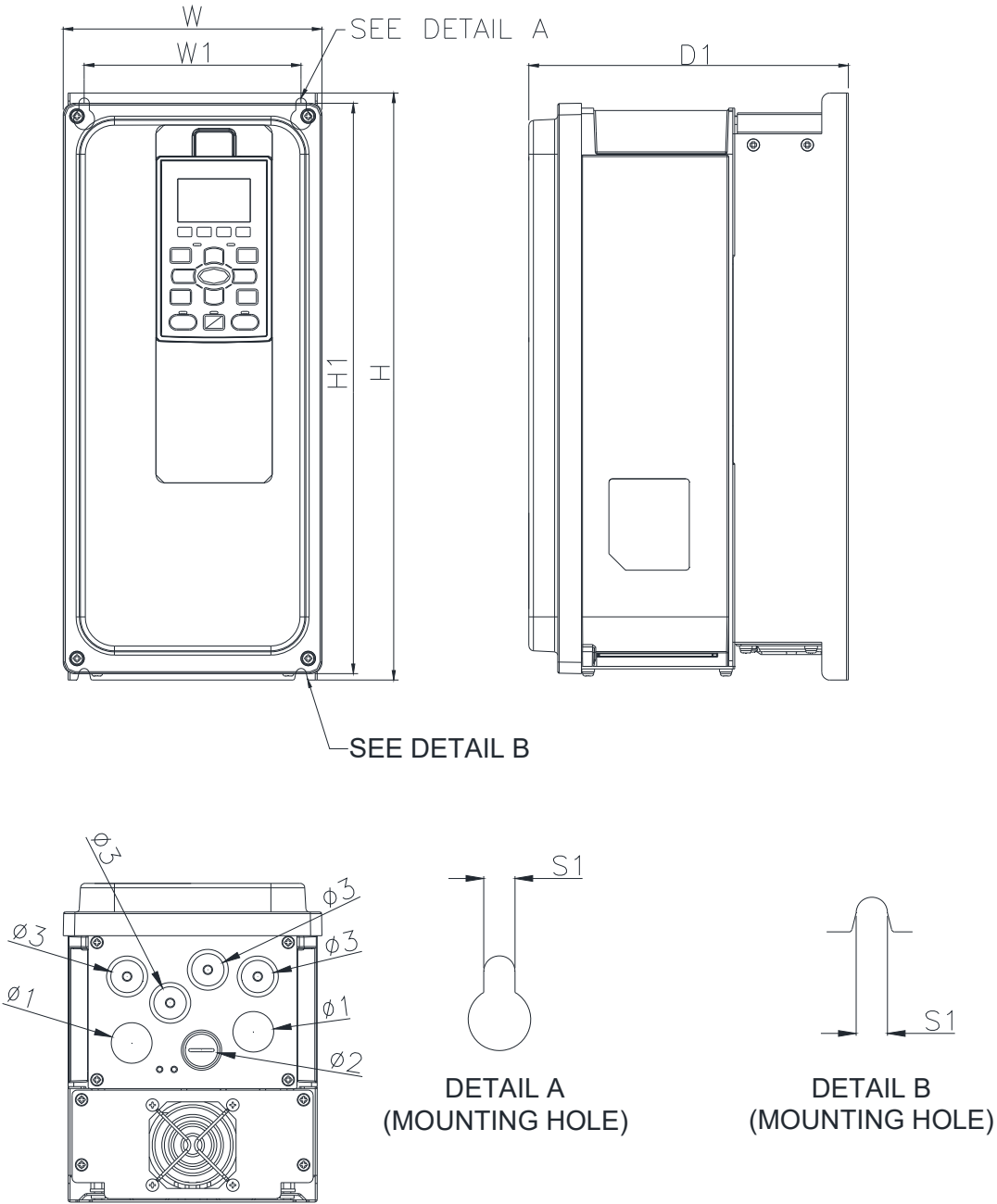

Unit: mm [inch]

Frame	W	W1	H	H1	D	D1	S1	$\phi 1$	$\phi 2$	$\phi 3$
A-1	161.0 [6.34]	135.0 [5.31]	366.4 [14.43]	356.0 [14.02]	-	199.0 [7.83]	6.5 [0.26]	25.4 [1.00]	20.3 [0.80]	20.3 [0.80]

Frame A

A-2: VFD007FP4EA-52S, VFD015FP4EA-52S, VFD022FP4EA-52S, VFD037FP4EA-52S,
 VFD040FP4EA-52S, VFD055FP4EA-52S, VFD075FP4EA-52S

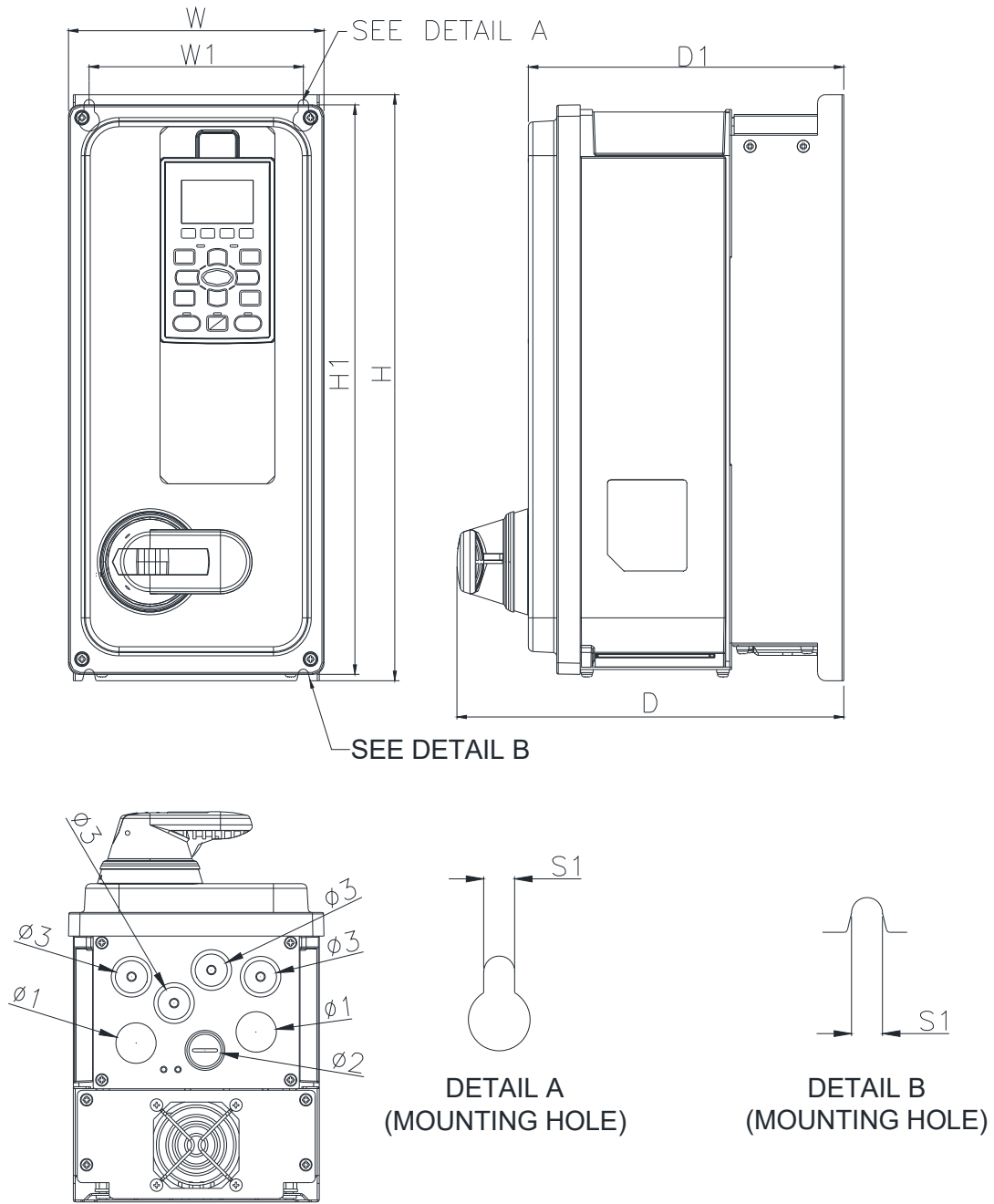

Unit: mm [inch]

Frame	W	W1	H	H1	D	D1	S1	Φ1	Φ2	Φ3
A-2	161.0 [6.34]	135.0 [5.31]	366.4 [14.43]	356.0 [14.02]	244.0 [9.61]	199.0 [7.83]	6.5 [0.26]	25.4 [1.00]	20.3 [0.80]	20.3 [0.80]

Frame A

A-3: VFD007FP4EA-41, VFD015FP4EA-41, VFD022FP4EA-41, VFD037FP4EA-41, VFD040FP4EA-41, VFD055FP4EA-41, VFD075FP4EA-41

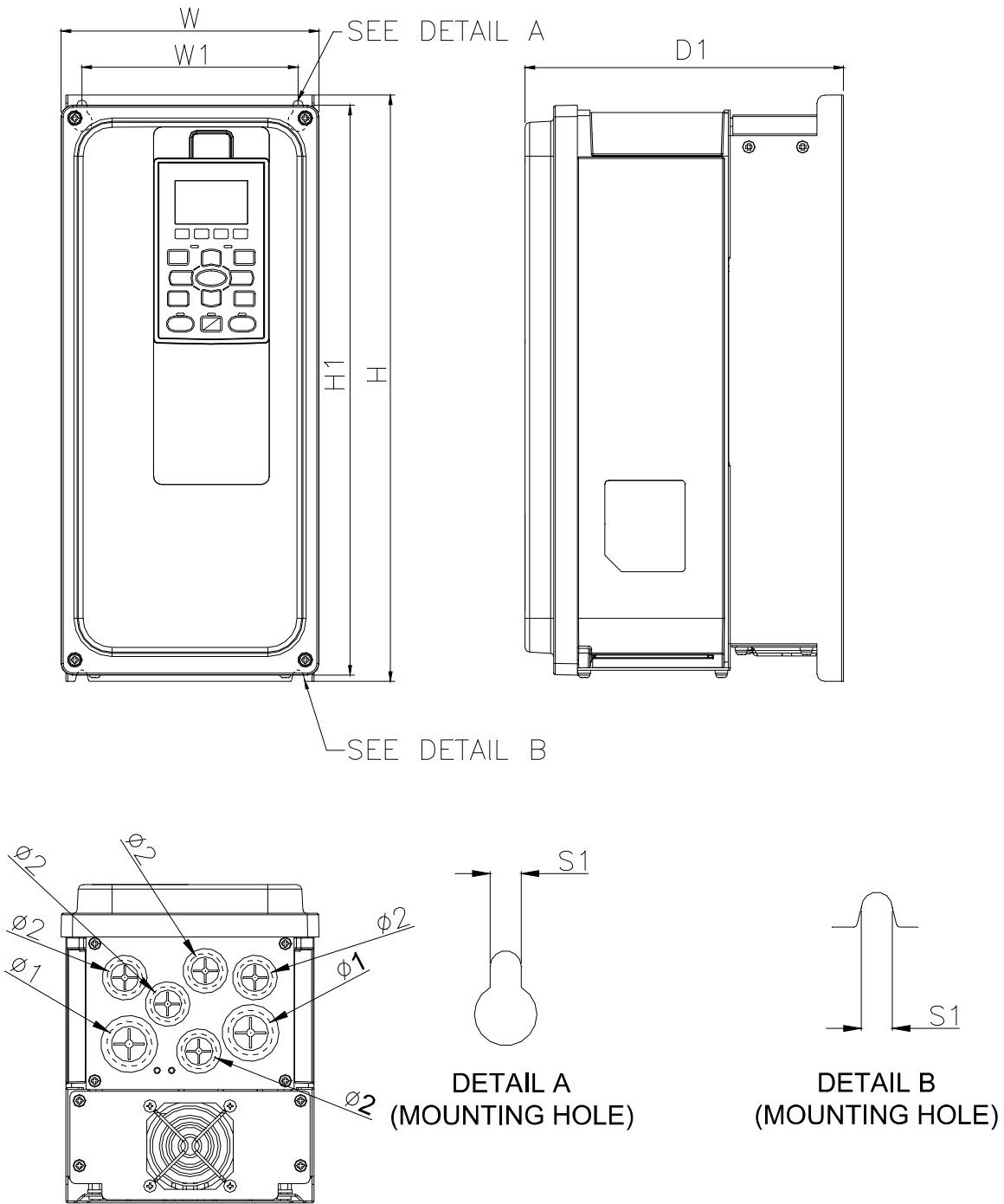

Unit: mm [inch]

Frame	W	W1	H	H1	D	D1	S1	Φ1	Φ2	Φ3
A-3	161.0 [6.34]	135.0 [5.31]	366.4 [14.43]	356.0 [14.02]	-	199.0 [7.83]	6.5 [0.26]	28.0 [1.10]	22.0 [0.87]	-

Frame B

B-1: VFD110FP4EA-52, VFD150FP4EA-52, VFD185FP4EA-52, VFD220FP4EA-52

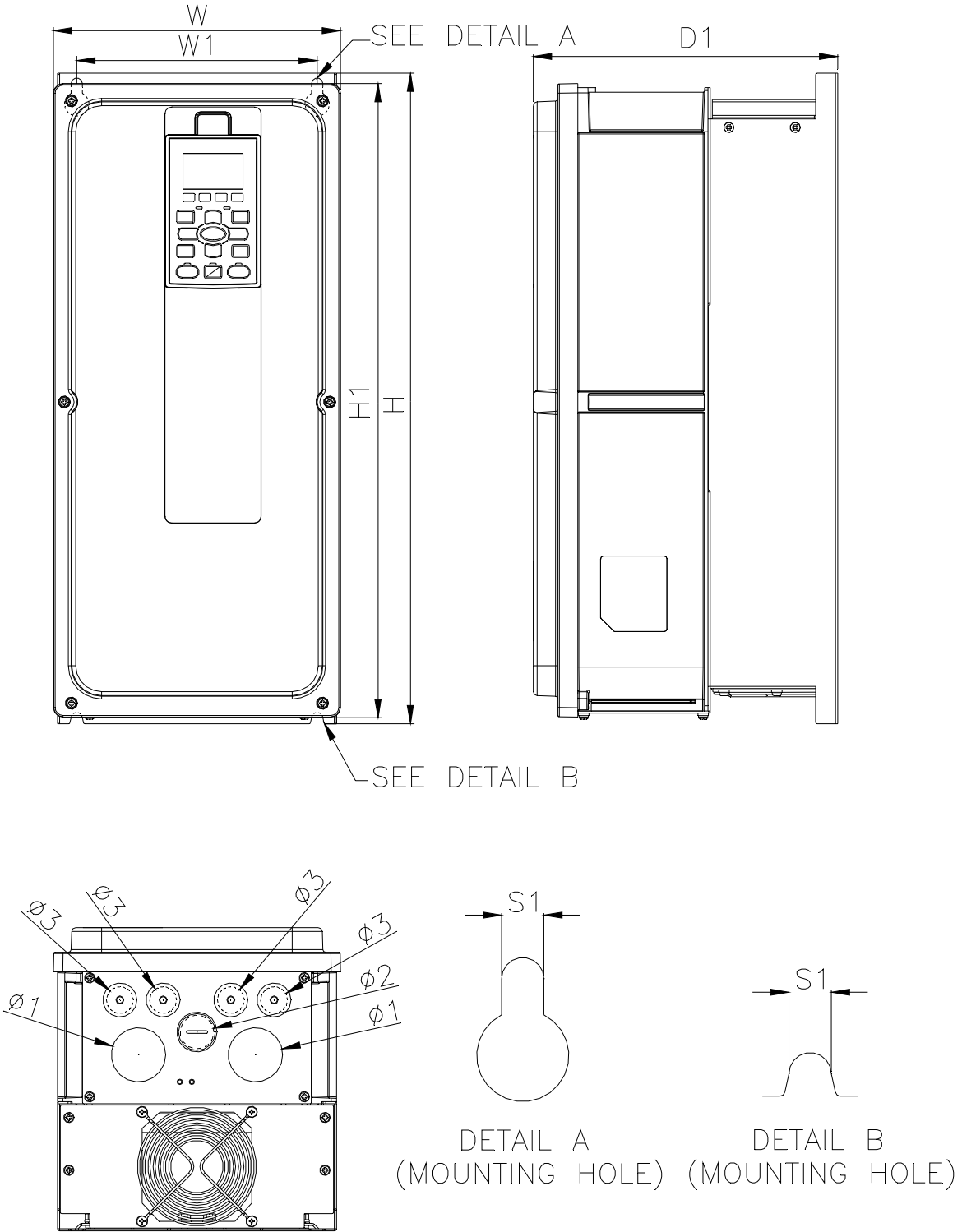

Unit: mm [inch]										
Frame	W	W1	H	H1	D	D1	S1	Φ1	Φ2	Φ3
B-1	216.0 [8.50]	181.0 [7.13]	491.4 [19.35]	479.0 [18.86]	-	229.0 [9.02]	8.5 [0.33]	41.0 [1.61]	25.4 [1.00]	20.3 [0.80]

Frame B

B-2: VFD110FP4EA-52S, VFD150FP4EA-52S, VFD185FP4EA-52S, VFD220FP4EA-52S

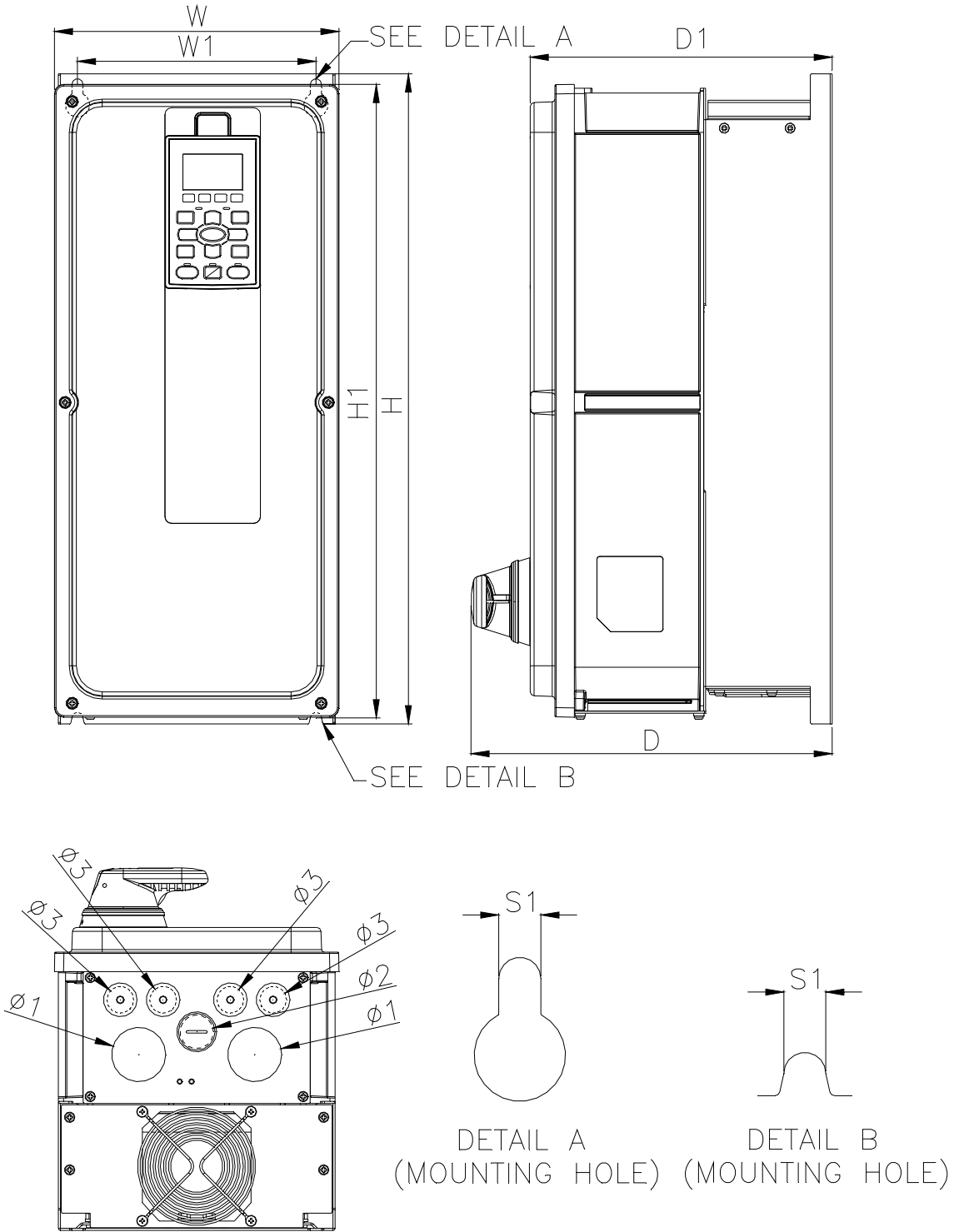

Unit: mm [inch]

Frame	W	W1	H	H1	D	D1	S1	φ1	φ2	φ3
B-2	216.0 [8.50]	181.0 [7.13]	491.4 [19.35]	479.0 [18.86]	274.0 [10.79]	229.0 [9.02]	8.5 [0.33]	41.0 [1.61]	25.4 [1.00]	20.3 [0.80]

Frame B

B-3: VFD110FP4EA-41, VFD150FP4EA-41, VFD185FP4EA-41, VFD220FP4EA-41

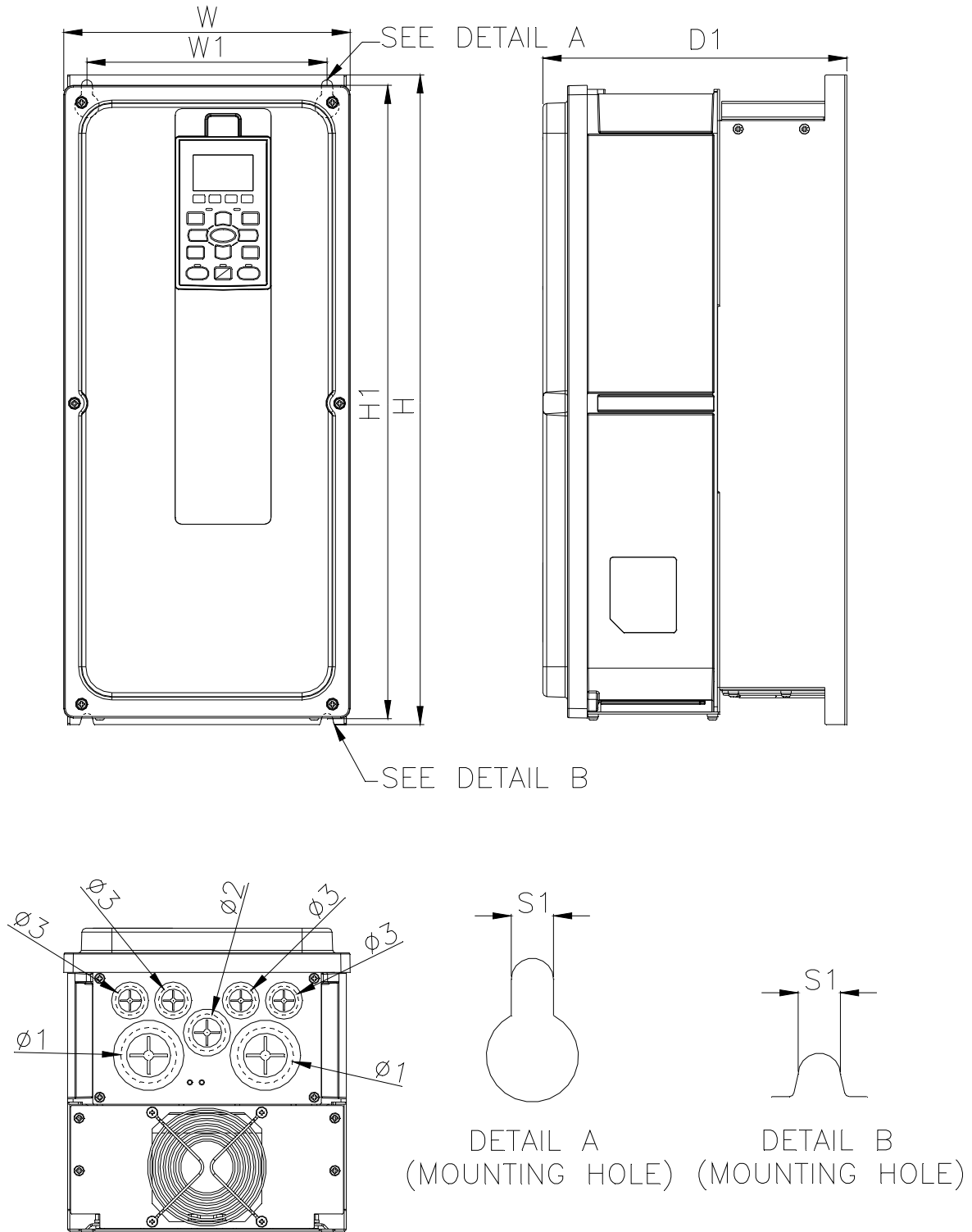

Frame	W	W1	H	H1	D	D1	S1	φ1	φ2	φ3
B-3	216.0 [8.50]	181.0 [7.13]	491.4 [19.35]	479.0 [18.86]	-	229.0 [9.02]	8.5 [0.33]	41.8 [1.65]	28.0 [1.10]	22.0 [0.87]

Unit: mm [inch]

Frame C

C-1: VFD300FP4EA-52, VFD370FP4EA-52

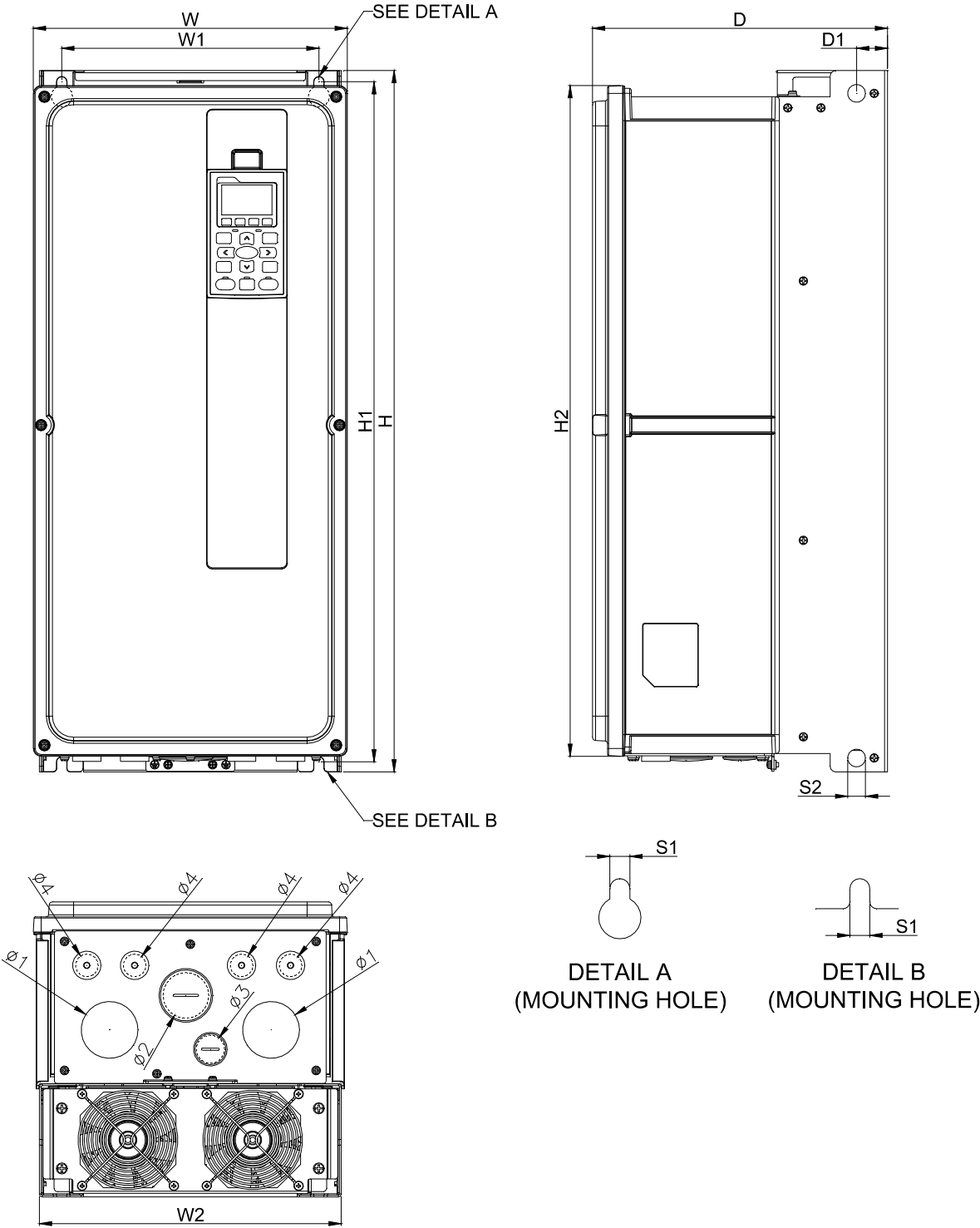

Unit: mm [inch]

Frame	W	W1	W2	H	H1	H2	D
C-1	282.0 [11.10]	231.0 [9.09]	271.0 [10.67]	630.0 [24.8]	611.0 [24.06]	602.5 [23.72]	265.0 [10.43]

Frame	D1	S1	S2	Φ1	Φ2	Φ3	Φ4
C-1	27.8 [1.09]	9.0 [0.35]	16.0 [0.63]	51.0 [2.01]	41.0 [1.61]	25.4 [1.00]	20.3 [0.80]

Frame C

C-2: VFD300FP4EA-52S, VFD370FP4EA-52S

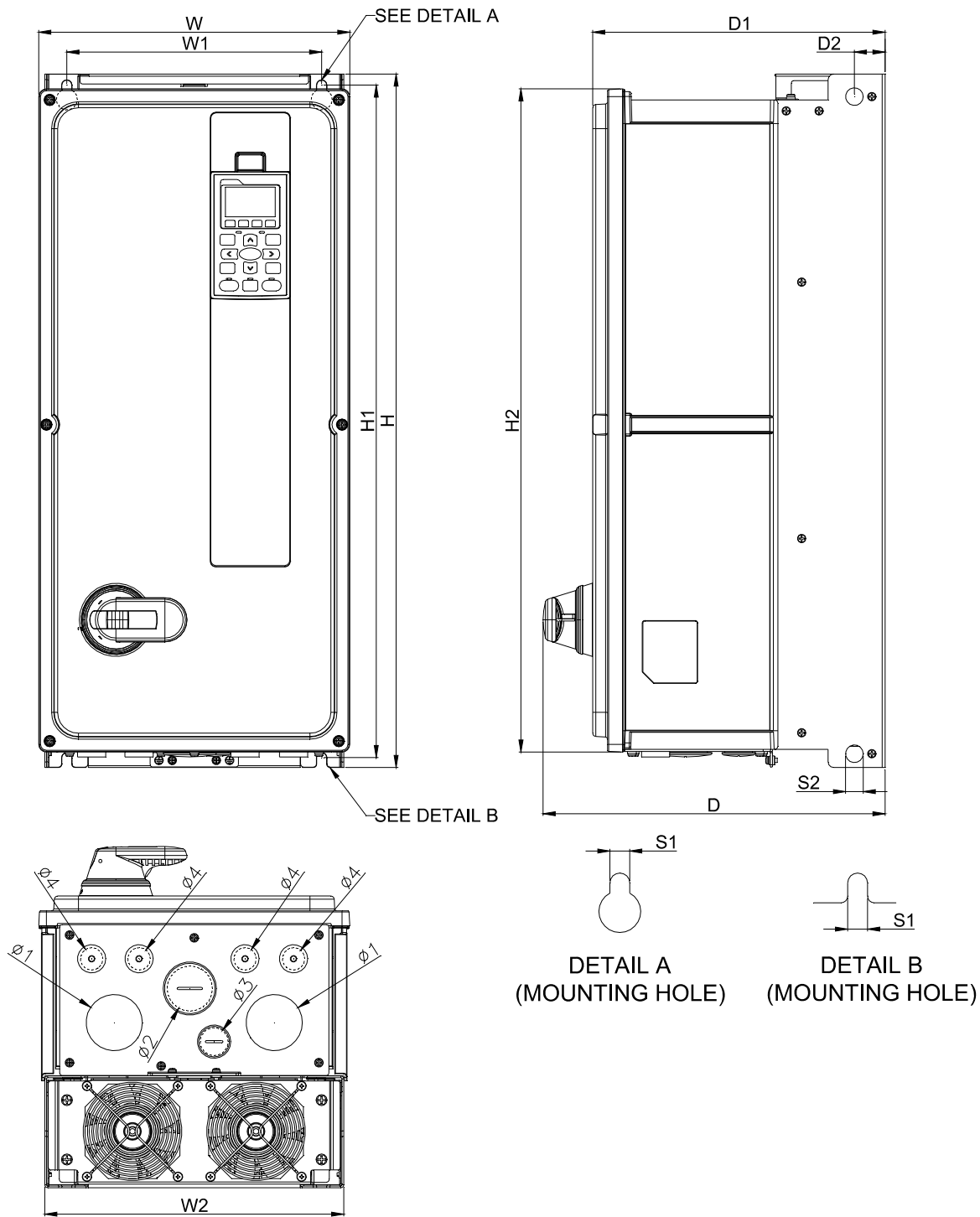

Unit: mm [inch]

Frame	W	W1	W2	H	H1	H2	D	D1
C-2	282.0 [11.10]	231.0 [9.09]	271.0 [10.67]	630.0 [24.8]	611.0 [24.06]	602.5 [23.72]	310.0 [12.20]	265.0 [10.43]

Frame	D2	S1	S2	φ1	φ2	φ3	φ4
C-2	27.8 [1.09]	9.0 [0.35]	16.0 [0.63]	51.0 [2.01]	41.0 [1.61]	25.4 [1.00]	20.3 [0.80]

Frame C

C-3: VFD300FP4EA-41, VFD370FP4EA-41

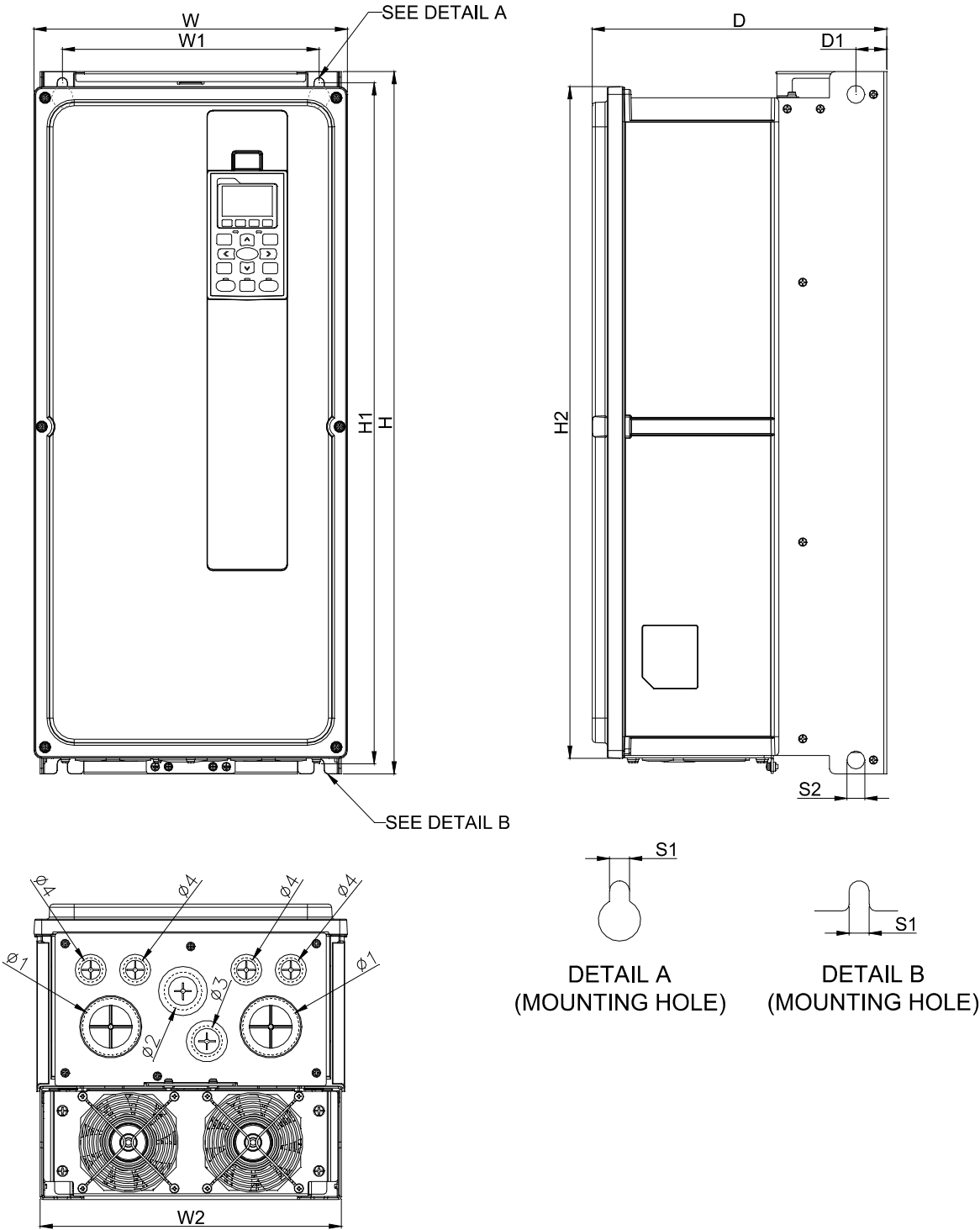

Unit: mm [inch]

Frame	W	W1	W2	H	H1	H2	D
C-3	282.0 [11.10]	231.0 [9.09]	271.0 [10.67]	630.0 [24.80]	611.0 [24.06]	602.5 [23.72]	265.0 [10.43]

Frame	D1	S1	S2	φ1	φ2	φ3	φ4
C-3	27.8 [1.09]	9.0 [0.35]	16.0 [0.63]	51.0 [2.01]	34.0 [1.34]	28.0 [1.10]	22.0 [0.87]

Frame D0

D0-1: VFD450FP4EA-52, VFD550FP4EA-52

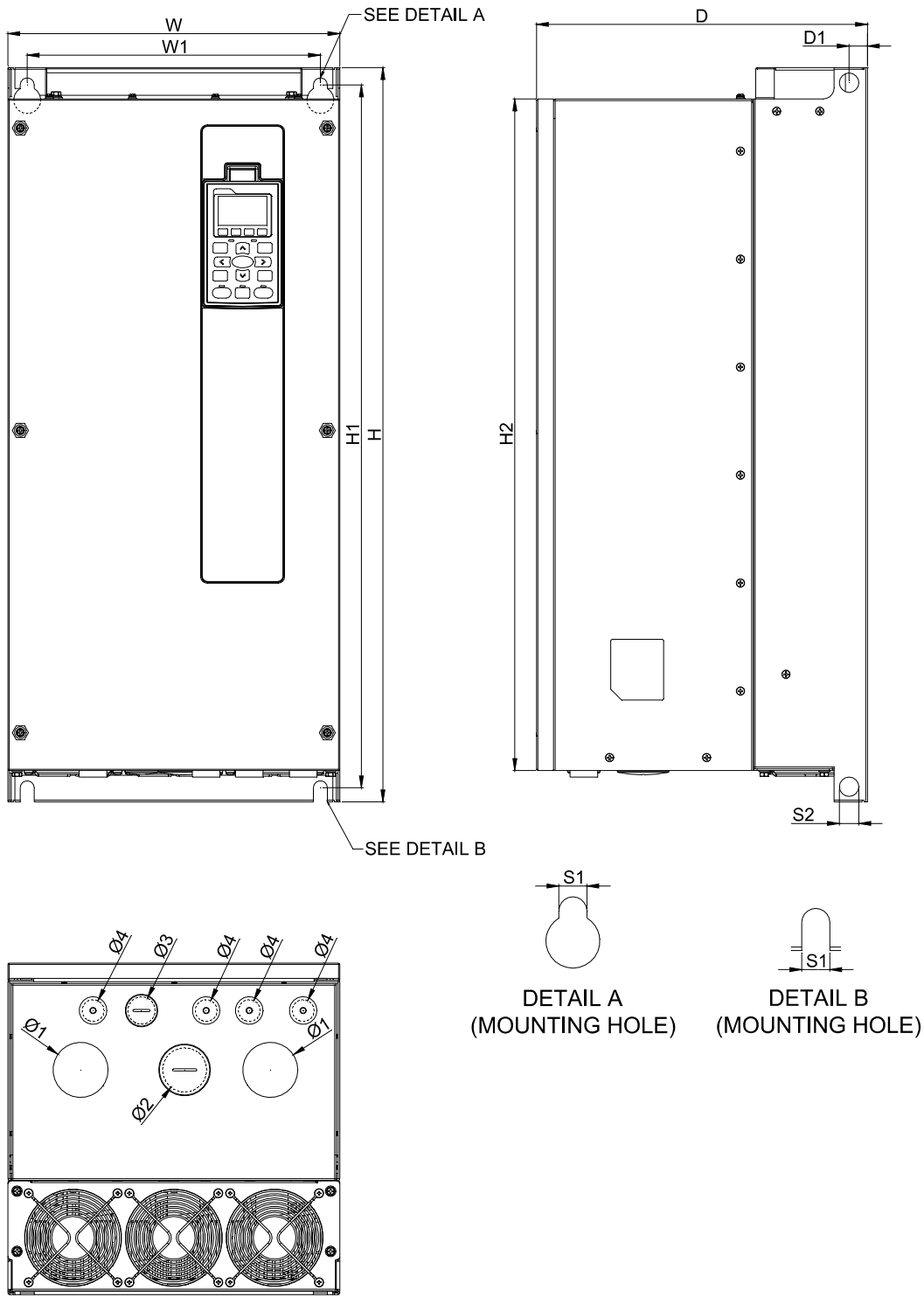

Unit: mm [inch]

Frame	W	W1	H	H1	H2	D
D0-1	308.0 [12.13]	272.0 [10.71]	680.0 [26.77]	651.0 [25.63]	622.0 [24.49]	307.0 [12.09]

Frame	D1	S1	S2	$\Phi 1$	$\Phi 2$	$\Phi 3$	$\Phi 4$
D0-1	17.0 [0.67]	13.0 [0.51]	18.0 [0.71]	51.0 [2.01]	41.0 [1.61]	25.4 [1.00]	20.3 [0.80]

Frame D0

D0-2: VFD450FP4EA-52S, VFD550FP4EA-52S

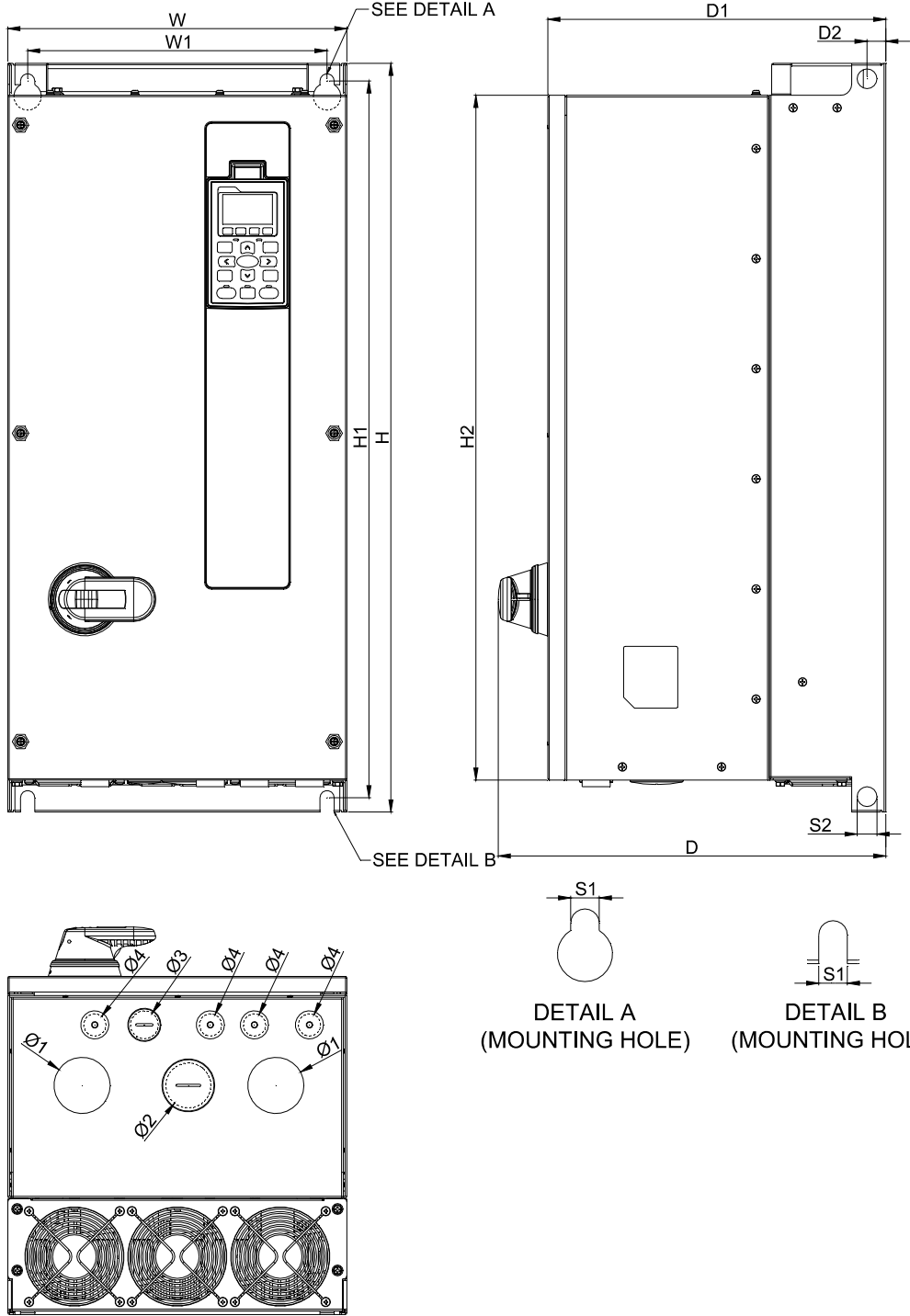

Unit: mm [inch]

Frame	W	W1	H	H1	H2	D	D1
D0-2	308.0 [12.13]	272.0 [10.71]	680.0 [26.77]	651.0 [25.63]	622.0 [24.49]	352.0 [13.86]	307.0 [12.09]

Frame	D2	S1	S2	Ø1	Ø2	Ø3	Ø4
D0-2	17.0 [0.67]	13.0 [0.51]	18.0 [0.71]	51.0 [2.01]	41.0 [1.61]	25.4 [1.00]	20.3 [0.80]

Frame D0

D0-3: VFD450FP4EA-41, VFD550FP4EA-41

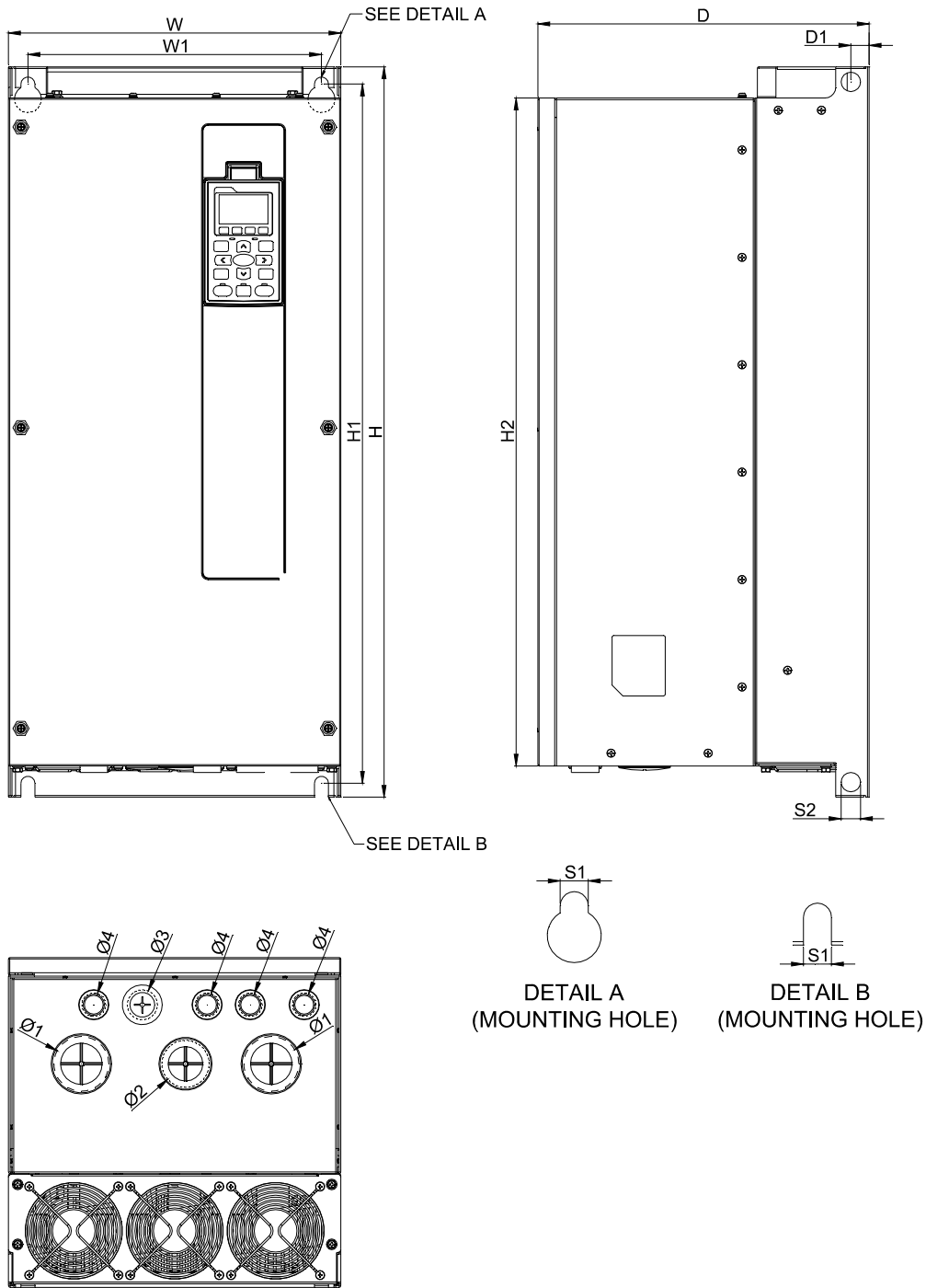

Unit: mm [inch]

Frame	W	W1	H	H1	H2	D
D0-3	308.0 [12.13]	272.0 [10.71]	680.0 [26.77]	651.0 [25.63]	622.0 [24.49]	307.0 [12.09]

Frame	D1	S1	S2	Φ1	Φ2	Φ3	Φ4
D0-3	17.0 [0.67]	13.0 [0.51]	18.0 [0.71]	51.0 [2.01]	44.0 [1.73]	28.0 [1.10]	22.0 [0.87]

Frame D

D-1: VFD750FP4EA-52, VFD900FP4EA-52

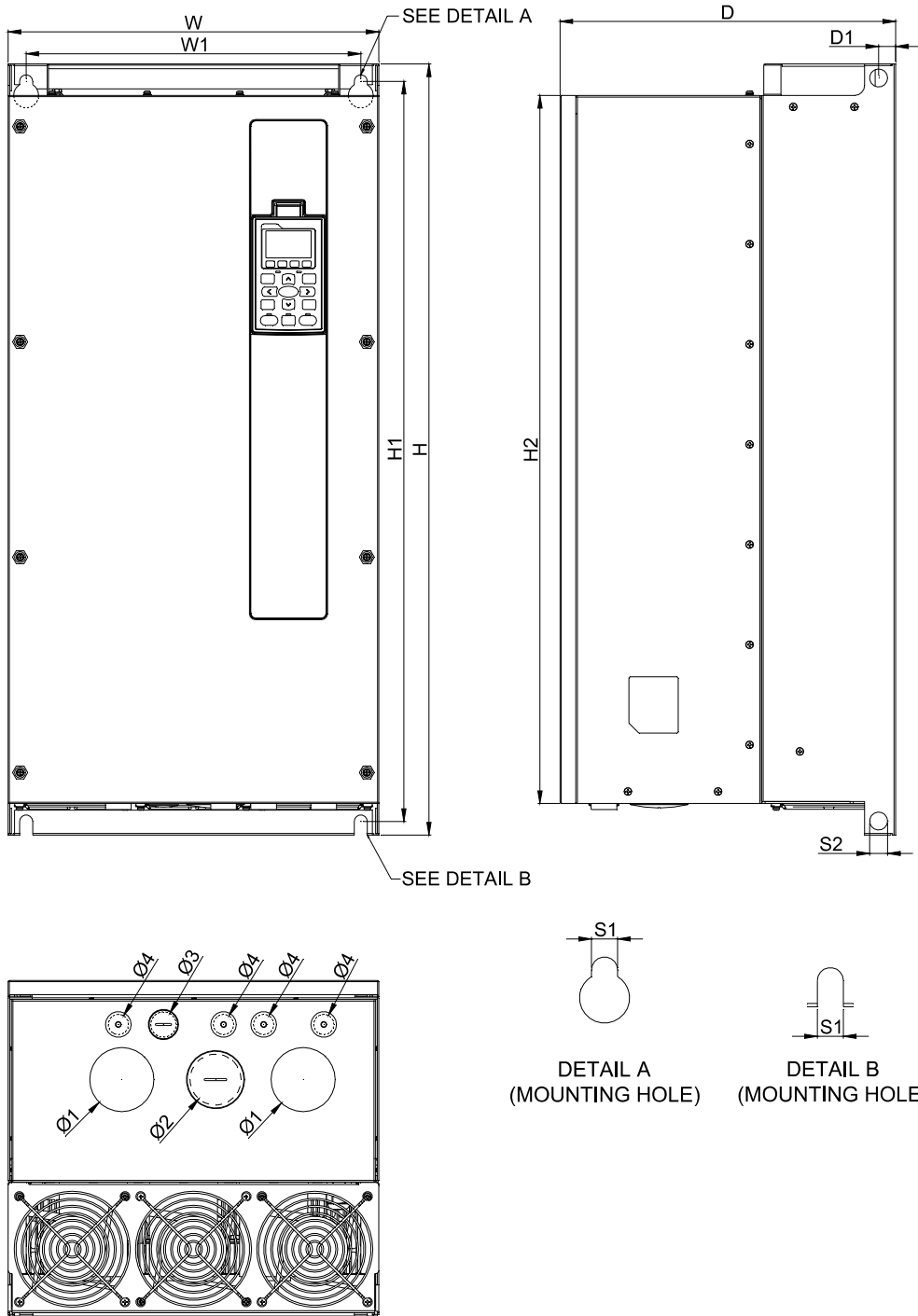

Unit: mm [inch]

Frame	W	W1	H	H1	H2	D
D-1	370.0 [14.57]	334.0 [13.15]	770.0 [30.31]	739.0 [29.09]	707.0 [27.83]	335.0 [13.19]

Frame	D1	S1	S2	Φ1	Φ2	Φ3	Φ4
D-1	17.0 [0.67]	13.0 [0.51]	18.0 [0.71]	64.0 [2.52]	51.0 [2.01]	25.4 [1.00]	20.3 [0.80]

Frame D

D-2: VFD750FP4EA-52S, VFD900FP4EA-52S

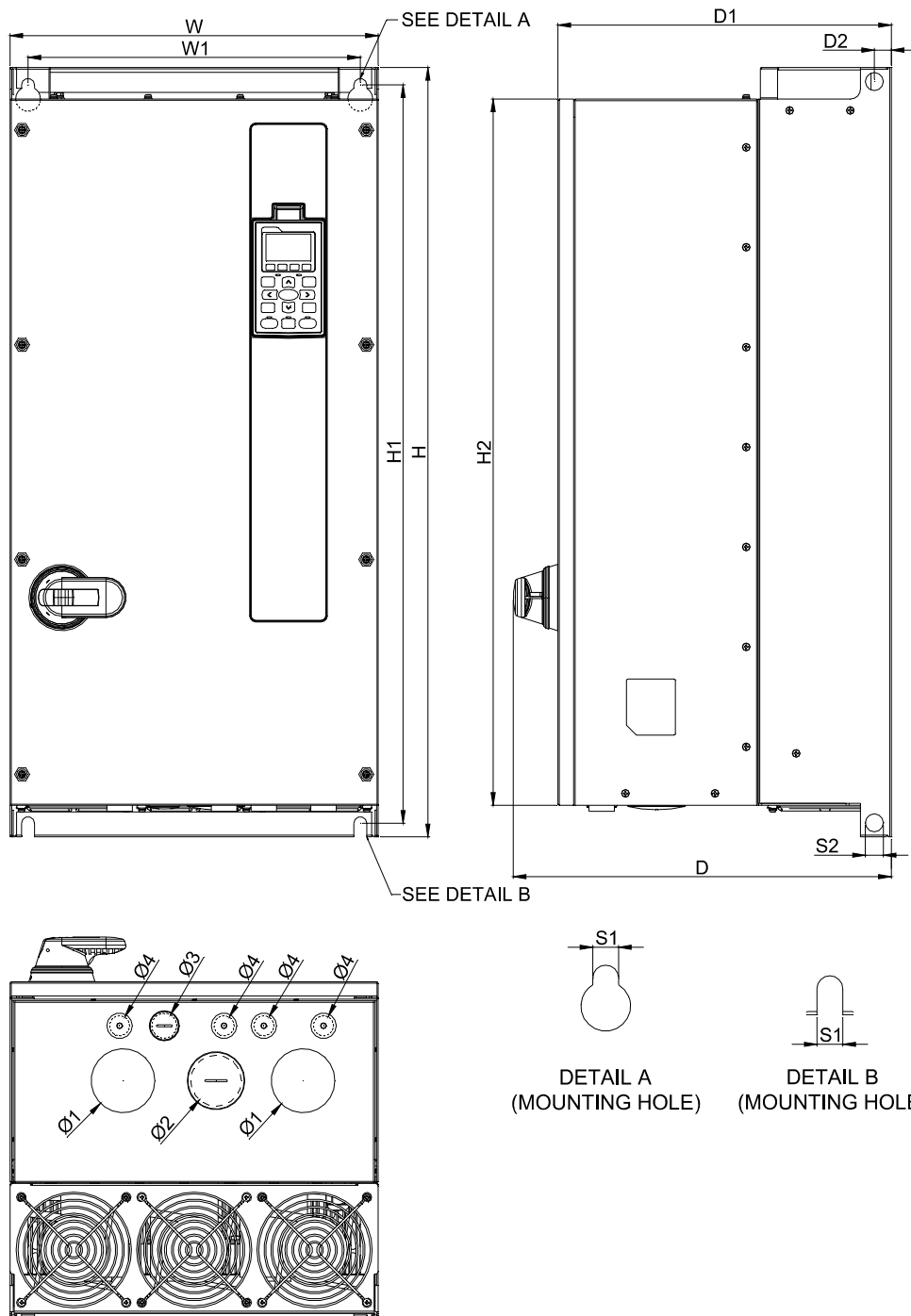

Unit: mm [inch]

Frame	W	W1	H	H1	H2	D	D1
D-2	370.0 [14.57]	334.0 [13.15]	770.0 [30.31]	739.0 [29.09]	707.0 [27.83]	380.0 [14.96]	335.0 [13.19]

Frame	D2	S1	S2	Ø1	Ø2	Ø3	Ø4
D-2	17.0 [0.67]	13.0 [0.51]	18.0 [0.71]	64.0 [2.52]	51.0 [2.01]	25.4 [1.00]	20.3 [0.80]

Frame D

D-3: VFD750FP4EA-41, VFD900FP4EA-41

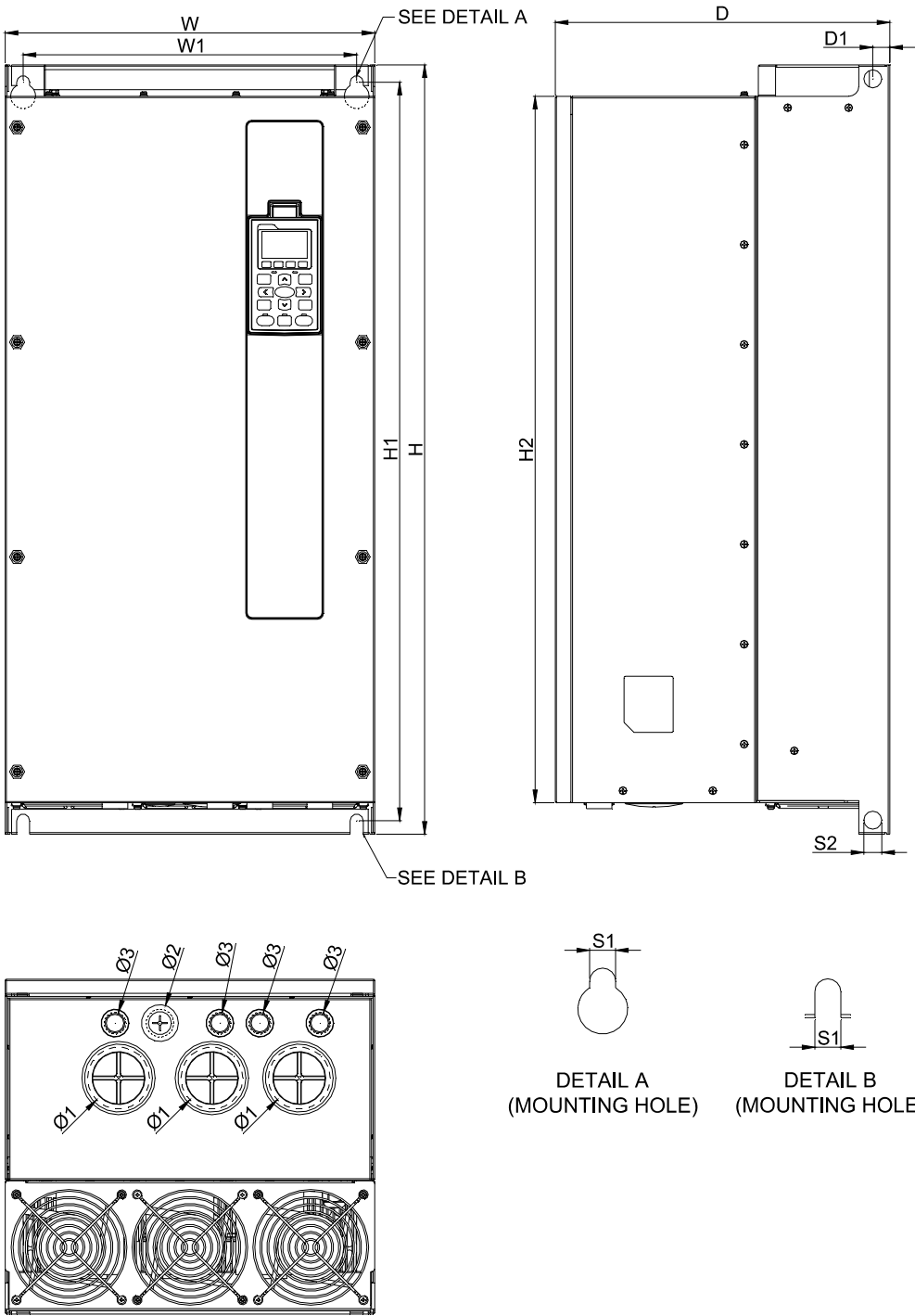

Unit: mm [inch]

Frame	W	W1	H	H1	H2	D
D-3	370.0 [14.57]	334.0 [13.15]	770.0 [30.31]	739.0 [29.09]	707.0 [27.83]	335.0 [13.19]

Frame	D1	S1	S2	Φ1	Φ2	Φ3	Φ4
D-3	17.0 [0.67]	13.0 [0.51]	18.0 [0.71]	62.0 [2.44]	28.0 [1.10]	22.0 [0.87]	—

1-7 Digital Keypad

KPC-CC02

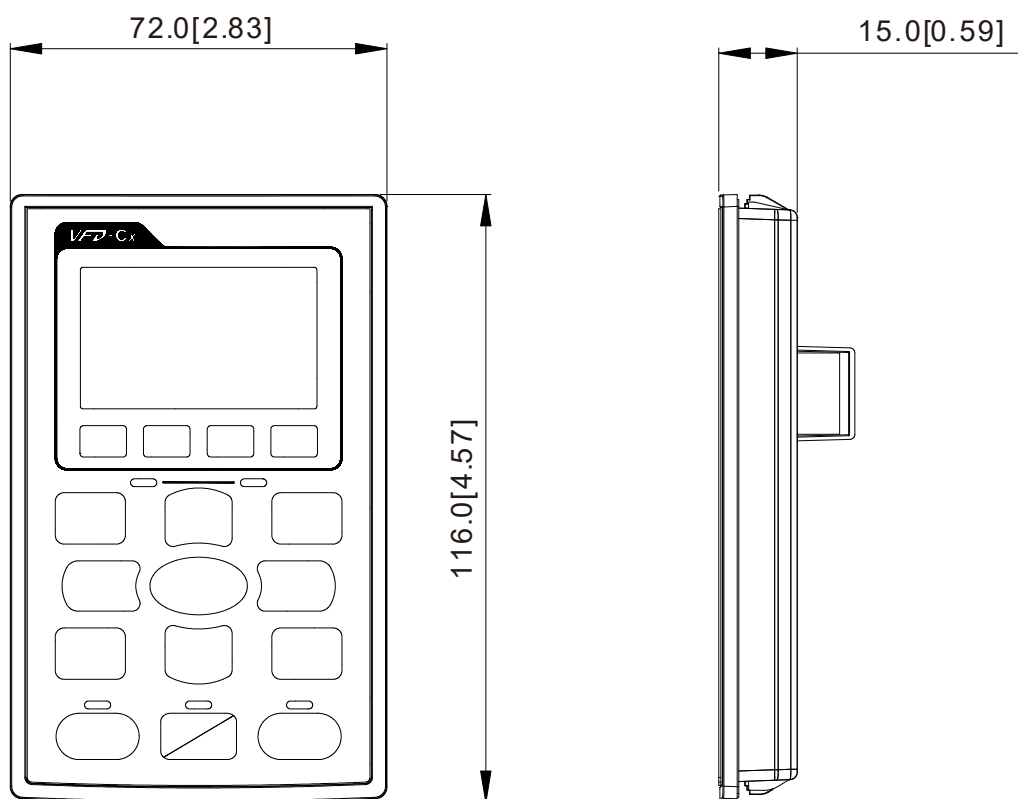

Chapter 2 Installation

Mounting Clearance

- ☑ Prevent fiber particles, scraps of paper, shredded wood saw dust, metal particles, etc. from adhering to the heat sink
- ☑ Install the AC motor drive in a metal cabinet. When installing one drive below another one, use a metal separation between the AC motor drives to prevent mutual heating and to prevent the risk of fire accident.
- ☑ Install the AC motor drive in Pollution Degree 2 environments only: normally only nonconductive pollution occurs and temporary conductivity caused by condensation is expected.

The appearances shown in the following figures are for reference only.

Airflow direction:  (Blue arrow) inflow  (Red arrow) outflow  (Black) distance

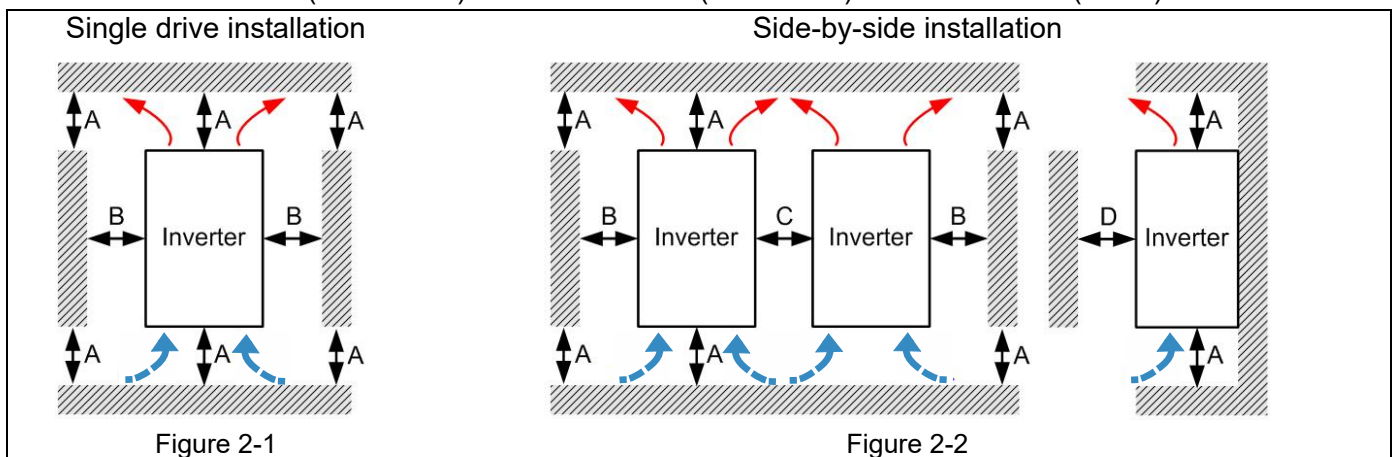

Figure 2-1

Figure 2-2

Multiple drives side-by-side installation in rows

For installation in rows, it is recommended installing a barrier between the drives. Adjust the size/depth of the barrier till the temperature measured at the fan's inflow side is lower than the operation temperature. Operation temperature is defined as the temperature measured 50mm away from the fan's inflow side. (As shown in the figure below)

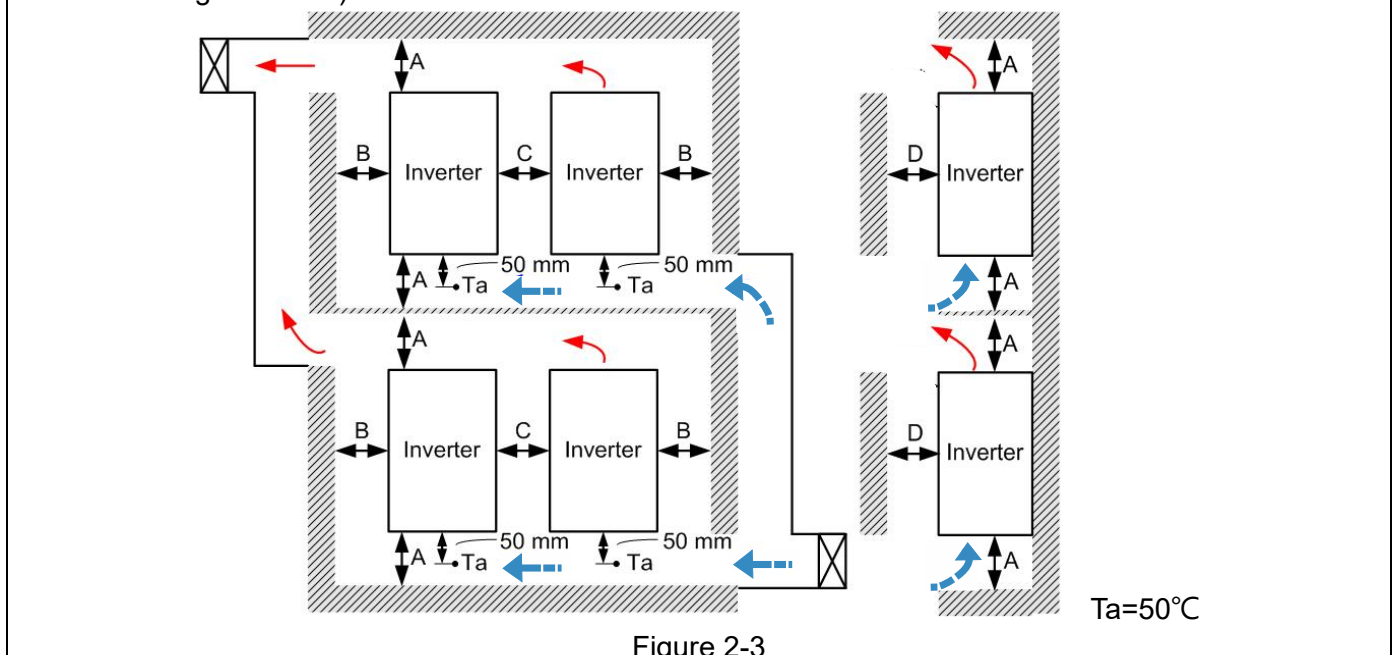

Figure 2-3

Minimum mounting clearance

Frame	A [mm]	B [mm]	C [mm]	D [mm]
A~B	60	15	-	-
C~D	100	25	-	-

NOTE

- ※ (As shown in the left figure). The mounting clearances are not for installing the drive in a confined space (such as cabinet or electric box). When installing in a confined space, except the same minimum mounting clearances, it needs to have the ventilation equipment or air conditioner to keep the surrounding temperature lower than the operation temperature.
- ※ The following table shows heat dissipation and the required air volume when installing a single drive in a confined space. When installing multiple drives, the required air volume shall be multiplied by the number of the drives.
- ※ Please refer to the chart “Air Flow Rate for Cooling” for ventilation equipment design and selection.
- ※ Please refer to the chart “Power Dissipation” for air conditioner design and selection.

Frame A	VFD007FP4EA-41, VFD007FP4EA-52, VFD007FP4EA-52S, VFD015FP4EA-41, VFD015FP4EA-52, VFD015FP4EA-52S, VFD022FP4EA-41, VFD022FP4EA-52, VFD022FP4EA-52S, VFD037FP4EA-41, VFD037FP4EA-52, VFD037FP4EA-52S, VFD040FP4EA-41, VFD040FP4EA-52, VFD040FP4EA-52S, VFD055FP4EA-41, VFD055FP4EA-52, VFD055FP4EA-52S, VFD075FP4EA-41, VFD075FP4EA-52, VFD075FP4EA-52S
Frame B	VFD110FP4EA-41, VFD110FP4EA-52, VFD110FP4EA-52S, VFD150FP4EA-41, VFD150FP4EA-52, VFD150FP4EA-52S, VFD185FP4EA-41, VFD185FP4EA-52, VFD185FP4EA-52S, VFD220FP4EA-41, VFD220FP4EA-52, VFD220FP4EA-52S
Frame C	VFD300FP4EA-41, VFD300FP4EA-52, VFD300FP4EA-52S, VFD370FP4EA-41, VFD370FP4EA-52, VFD370FP4EA-52S
Frame D0	VFD450FP4EA-41, VFD450FP4EA-52, VFD450FP4EA-52S, VFD550FP4EA-41, VFD550FP4EA-52, VFD550FP4EA-52S
Frame D	VFD750FP4EA-41, VFD750FP4EA-52, VFD750FP4EA-52S, VFD900FP4EA-41, VFD900FP4EA-52, VFD900FP4EA-52S

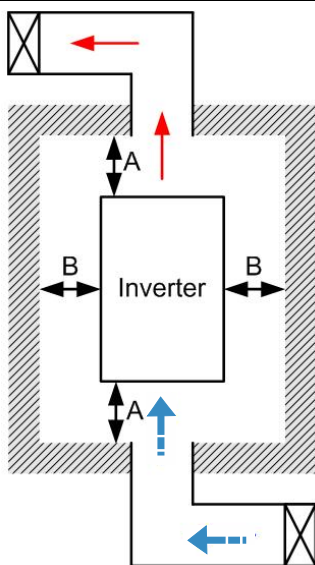

Figure 2-4

NOTE

- ※ The mounting clearance stated in the figure is for installing the drive in an open area. To install the drive in a confined space (such as cabinet or electric box), please follow the following rules: (1) Keep the minimum mounting clearances. (2) Install a ventilation equipment or an air conditioner to keep surrounding temperature lower than operation temperature.
- ※ The following table shows the heat dissipation and the required air volume when installing a single drive in a confined space. When installing multiple drives, the required air volume shall be multiplied by the number the drives.
- ※ Refer to the chart (Air flow rate for cooling) for ventilation equipment design and selection.
- ※ Refer to the chart (Power dissipation) for air conditioner design and selection.
- ※ Different control mode will affect the derating. See Pr06-55 for more information.
- ※ Ambient temperature derating curve shows the derating status in different temperature in relation to different protection level.

Model No.	Air flow rate for cooling			Power dissipation of AC motor drive		
	Flow Rate [cfm]			Power Dissipation [watt]		
	External	Internal	Total	Loss External	Internal	Total
VFD007FP4EA-41/ 52 / 52S	-	14	14	32	20	52
VFD015FP4EA-41/ 52 / 52S	-	14	14	43	21	64
VFD022FP4EA-41/ 52 / 52S	34	14	48	74	25	99
VFD037FP4EA-41/ 52 / 52S	34	14	48	92	26	118
VFD040FP4EA-41/ 52 / 52S	34	14	48	113	26	139
VFD055FP4EA-41/ 52 / 52S	34	14	48	139	27	166
VFD075FP4EA-41/ 52 / 52S	34	14	48	195	29	224
VFD110FP4EA-41/ 52 / 52S	88	14	102	240	34	274
VFD150FP4EA-41/ 52 / 52S	88	14	102	309	38	347
VFD185FP4EA-41/ 52 / 52S	88	14	102	353	39	392
VFD220FP4EA-41/ 52 / 52S	88	14	102	449	47	496
VFD300FP4EA-41/ 52 / 52S	200	29	229	618	84	702
VFD370FP4EA-41/ 52 / 52S	200	29	229	726	87	813
VFD450FP4EA-41/ 52 / 52S	285	29	314	864	82	946
VFD550FP4EA-41/ 52 / 52S	285	29	314	1068	84	1152
VFD750FP4EA-41/ 52 / 52S	330	29	359	1407	111	1518
VFD900FP4EA-41/ 52 / 52S	330	29	359	1623	114	1737
	※ The required airflow shown in chart is for installing single drive in a confined space. ※ When installing the multiple drives, the required air volume should be the required air volume for single drive X the number of the drives.			※ The heat dissipation shown in the chart is for installing single drive in a confined space. ※ When installing the multiple drives, volume of heat dissipation should be the heat dissipated for single drive X the number of the drives. ※ Heat dissipation for each model is calculated by rated voltage, current and default carrier.		

 **NOTE**

Normal control Ambient temperature derating curve

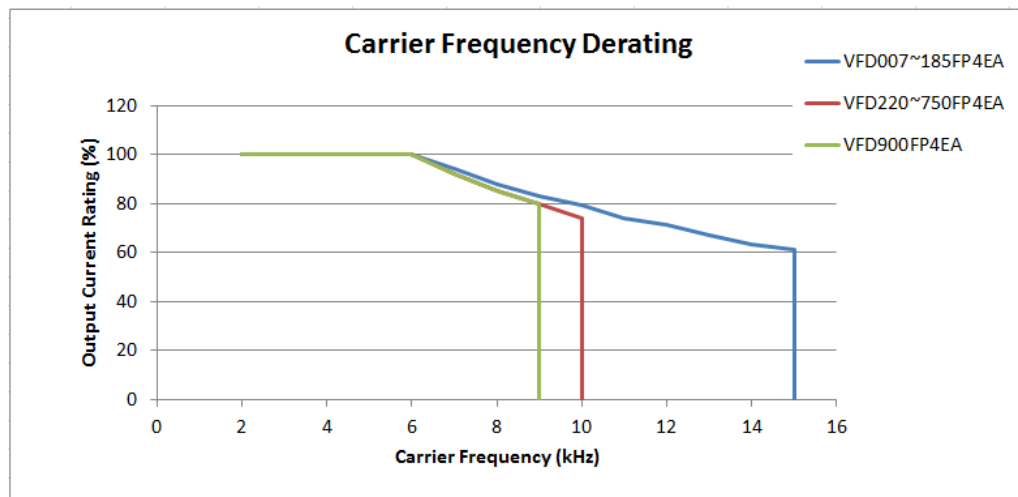

[This page intentionally left blank]

Chapter 3 Unpacking

3-1 Unpacking

3-2 The Lifting Hook

The AC motor drive should be kept in the shipping carton or crate before installation. In order to retain the warranty coverage, the AC motor drive should be stored properly when it is not to be used for an extended period of time.

3-1 Unpacking

The AC motor drive is packed in the crate. Follows the following step for unpack:

Frame D0

VFD450FP4EA-41, VFD450FP4EA-52, VFD450FP4EA-52S,
VFD550FP4EA-41, VFD550FP4EA-52, VFD550FP4EA-52S

1. Remove the 4 clips by slotted screwdriver.

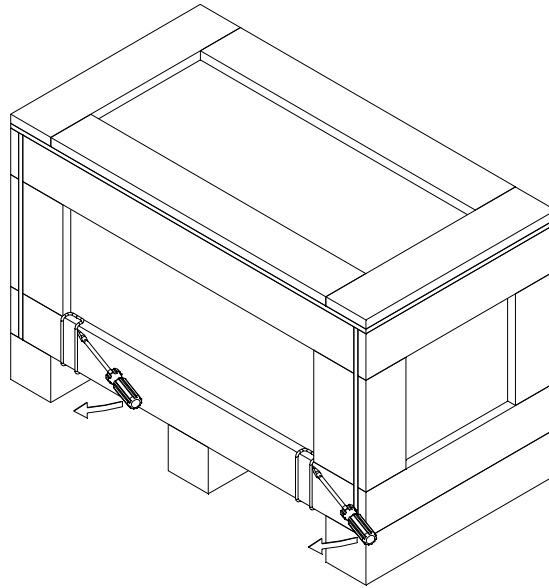

2. Remove the cover of wood box and then take out the EPE tray and user manual.

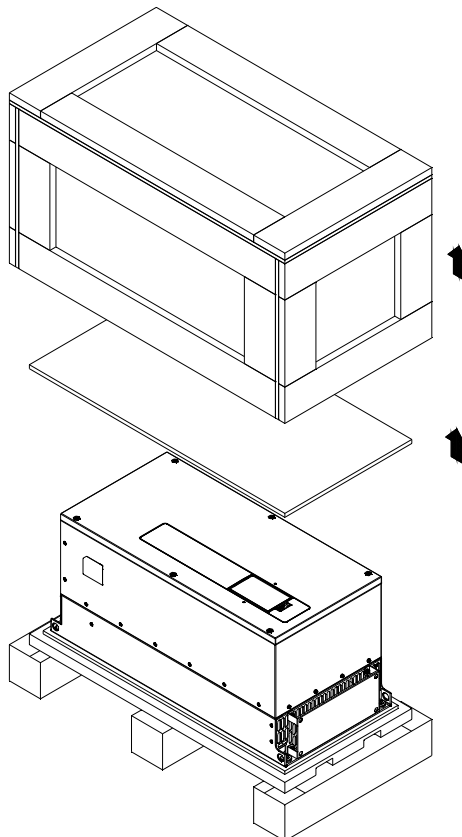

3. Loosen the 5 screws that fastened on the pallet.

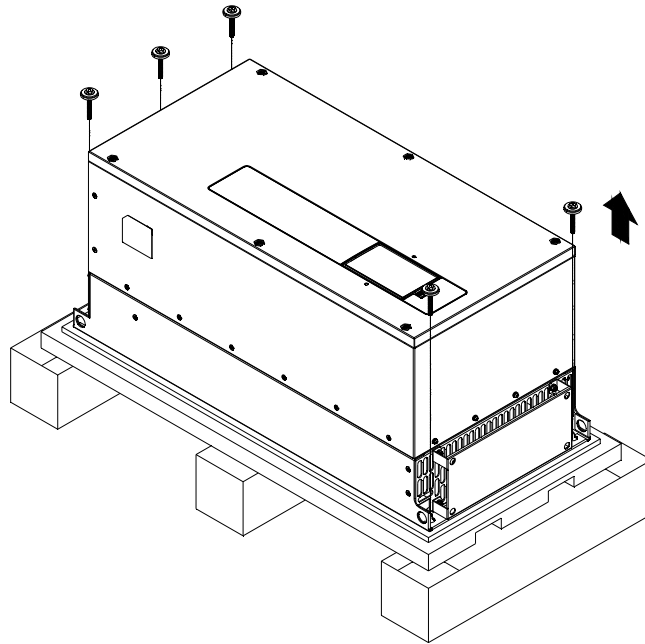

4. Lift up the drive by using hooks through the holes.

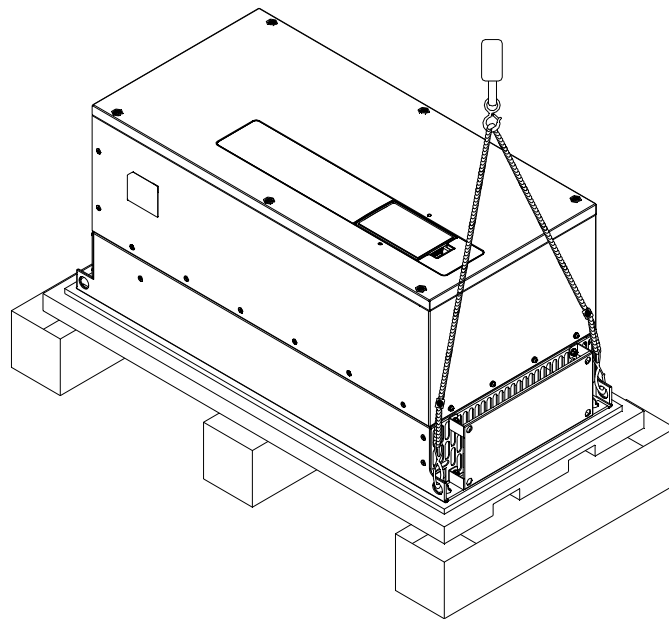

Frame D

VFD750FP4EA-41, VFD750FP4EA-52, VFD750FP4EA-52S,
VFD900FP4EA-41, VFD900FP4EA-52, VFD900FP4EA-52S

1. Remove the 6 clips by slotted screwdriver.

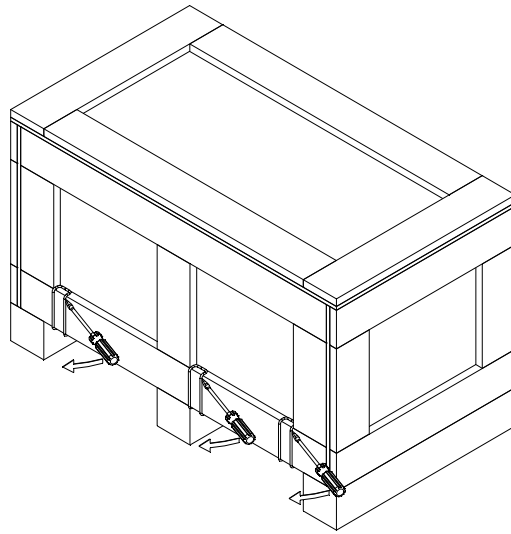

2. Remove the cover of wood box and then take out the EPE tray and user manual.

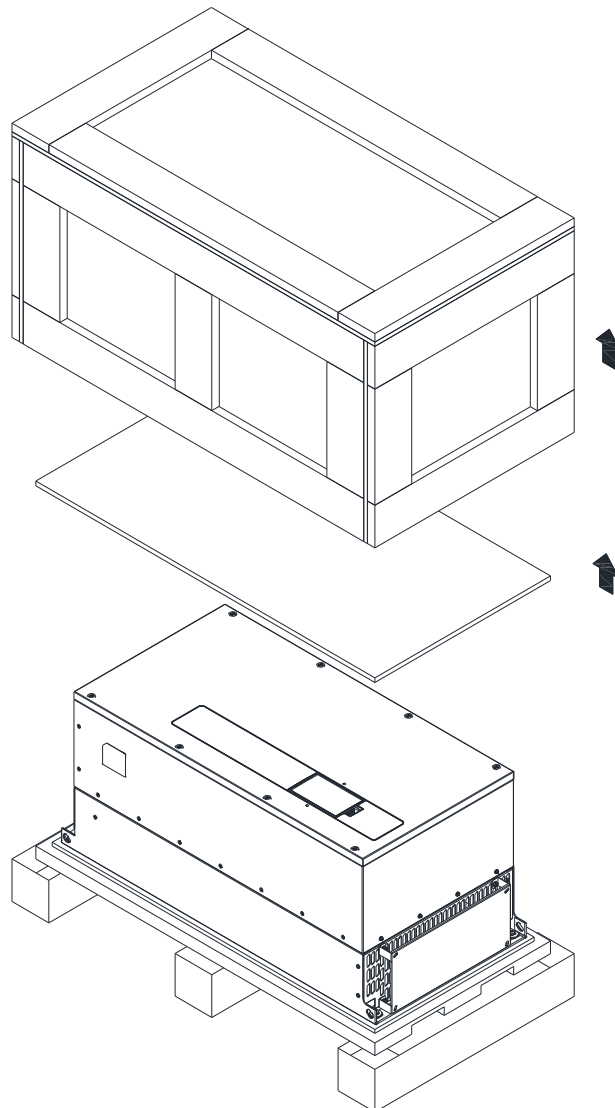

3. Loosen the 4 screws that fastened on the pallet.

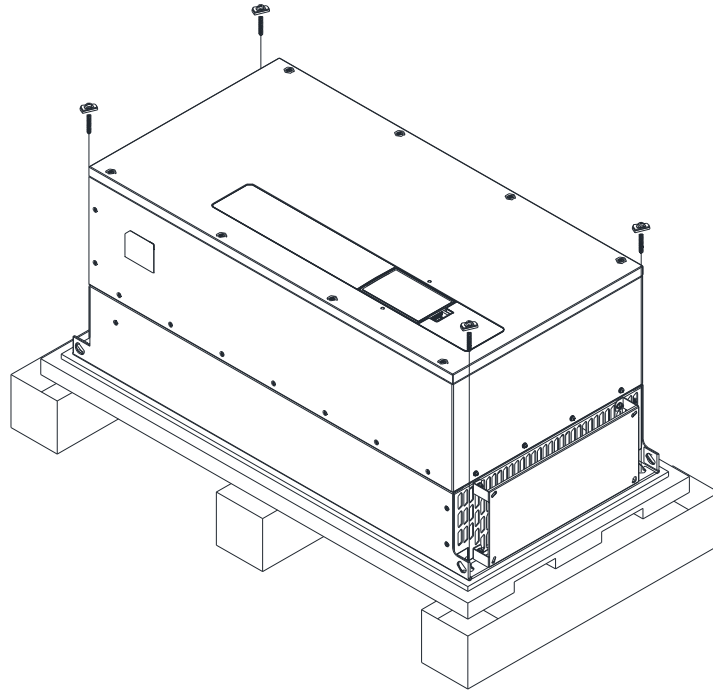

4. Lift up the drive by using hooks through the holes.

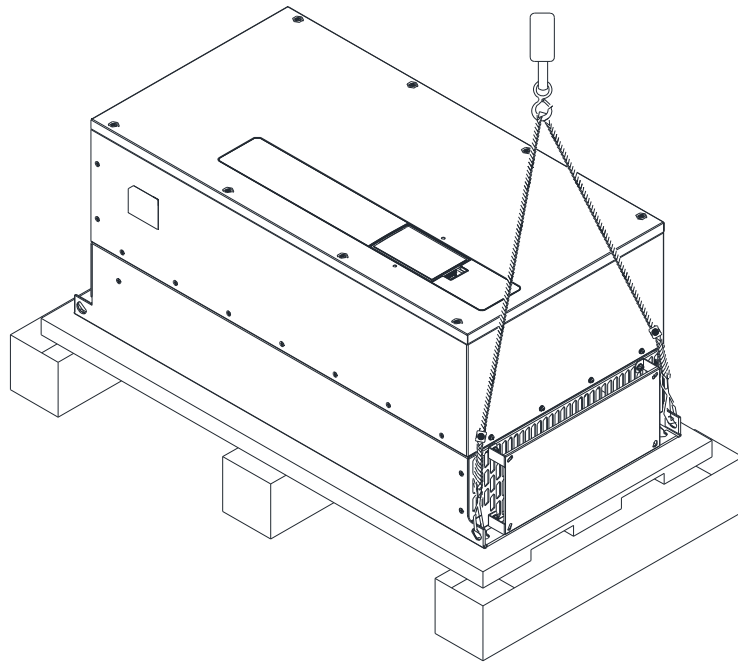

3-2 The Lifting Hook

The arrows indicate the location of the lifting holes, as shown in figure below:

Frame D0

Frame D

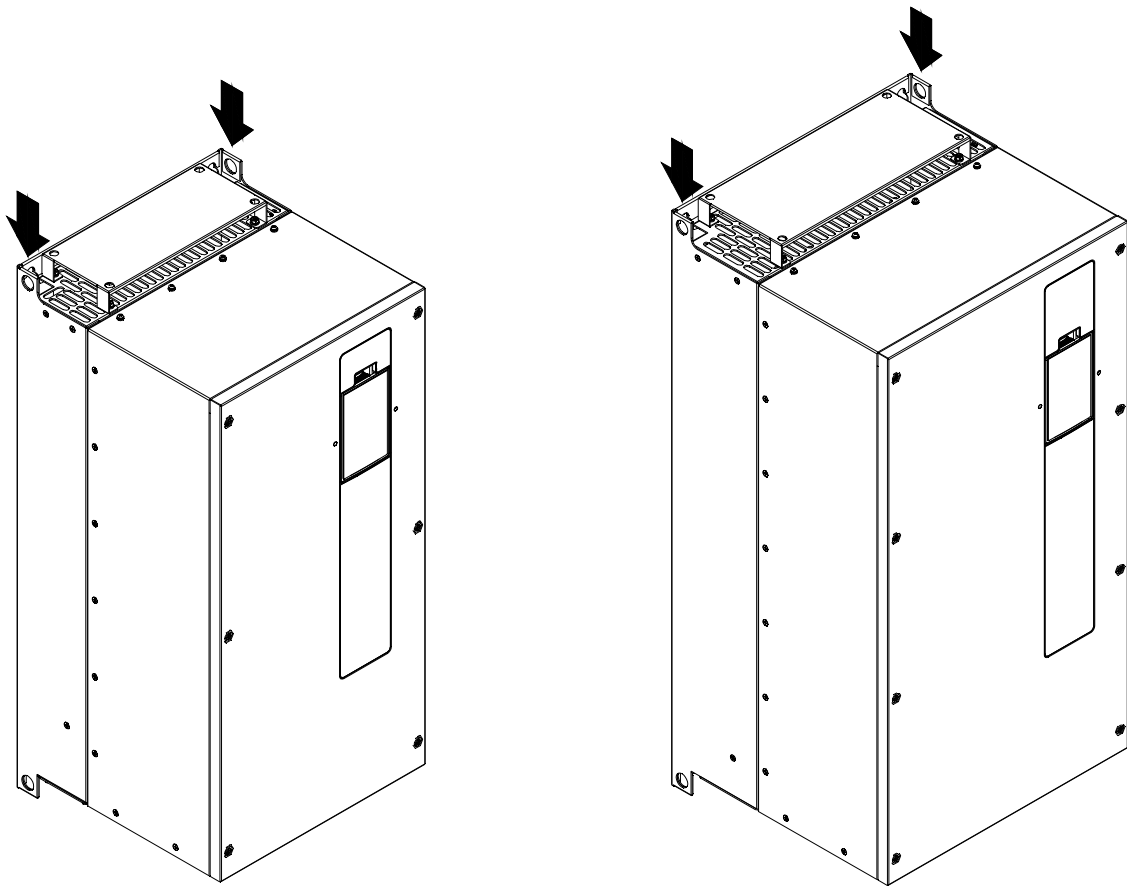

Ensure the lifting hook properly goes through the lifting hole, as shown in the following diagram.

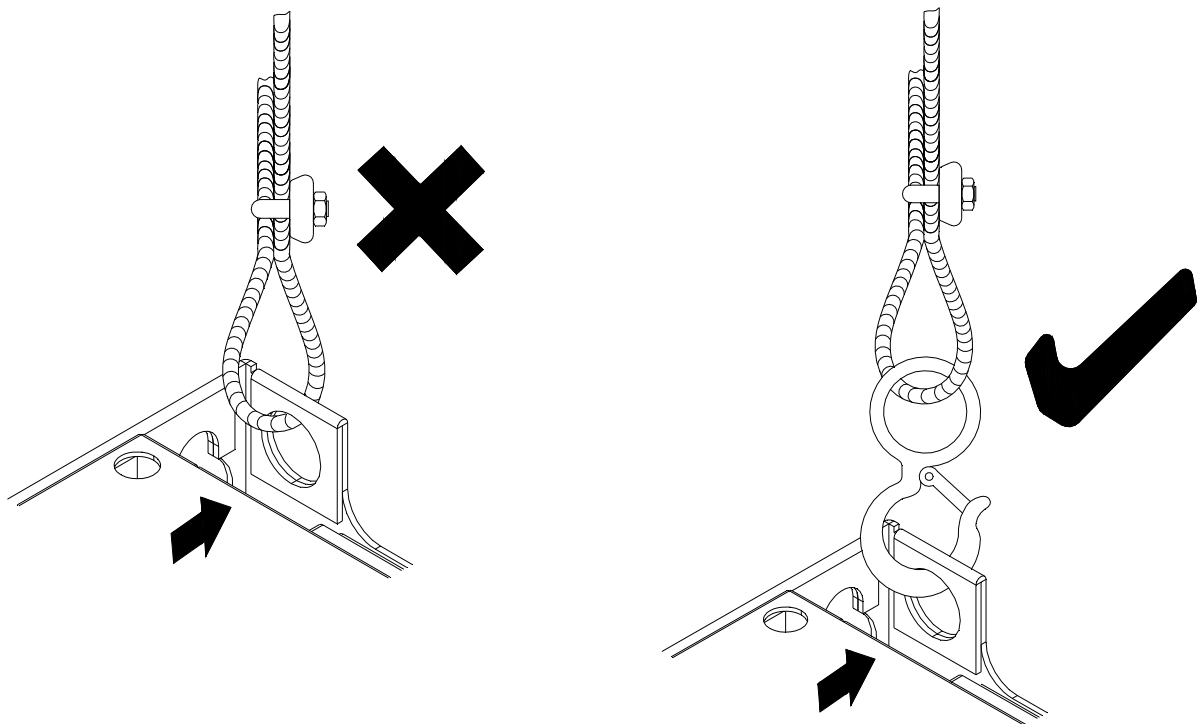

Ensure the angle between the lifting holes and the lifting device is within the specification, as shown in the following figure.

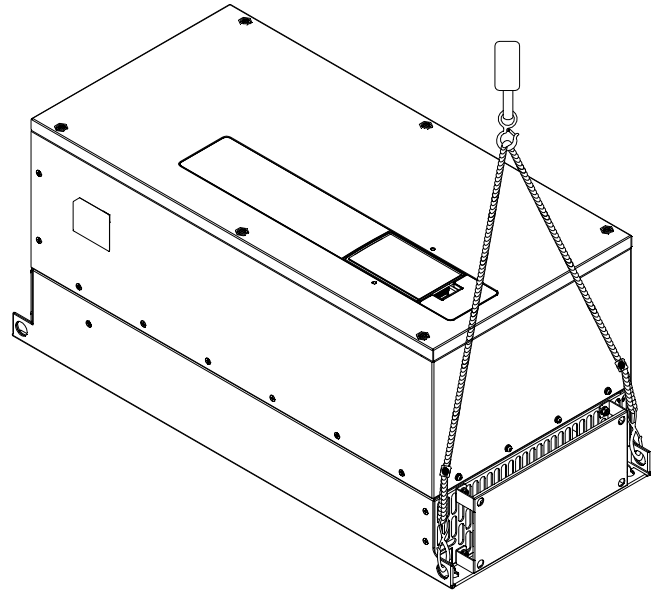
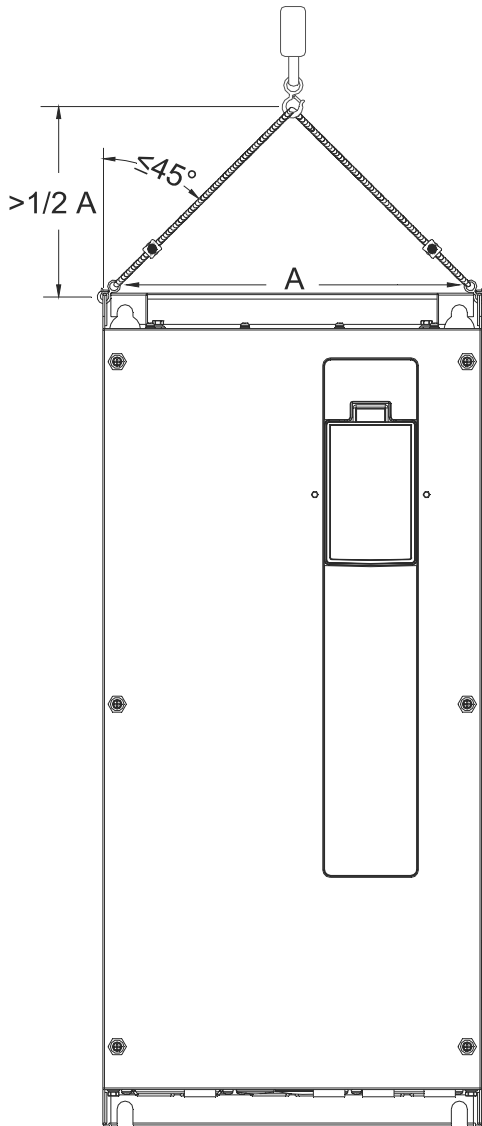

Weight of Models

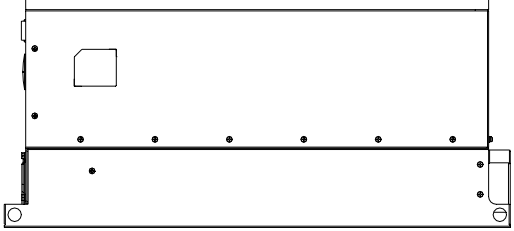
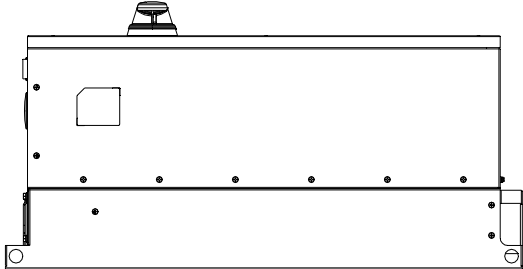
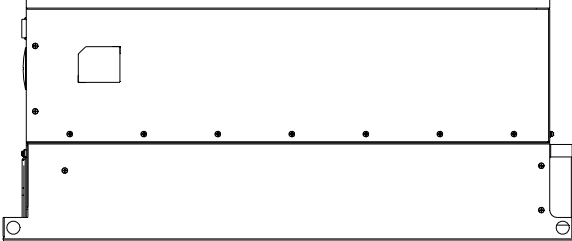
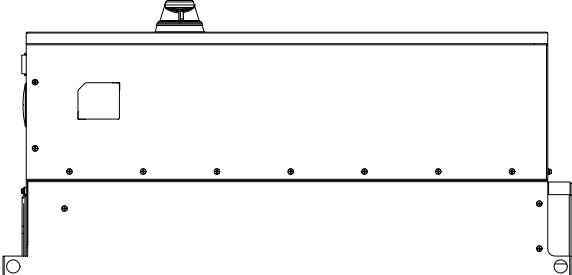
Frame	VFDXXXFP4EA-41 VFDXXXFP4EA-52	VFDXXXFP4EA-52S
D0	<p>41.5 kg [91.4 lbs.]</p>  <p>The diagram shows a side view of a rectangular frame with a horizontal base and a vertical back panel. A square cutout is visible on the left side of the back panel. The base has several mounting points along its length. The frame is shown without any top components.</p>	<p>41.7 kg [91.9 lbs.]</p>  <p>The diagram shows the same rectangular frame as the previous one, but with a small, dark, dome-shaped component mounted on top of the back panel.</p>
D	<p>59.0 kg [130.0 lbs.]</p>  <p>The diagram shows the same rectangular frame as in the D0 row, but with a horizontal bar or rail mounted across the top of the back panel. The square cutout and mounting points on the base are also present.</p>	<p>60.2 kg [132.6 lbs.]</p>  <p>The diagram shows the same rectangular frame as in the D0 row, but with both a horizontal bar or rail mounted across the top of the back panel and a small, dark, dome-shaped component mounted on top of the back panel.</p>

Chapter 4 Wiring

4-1 System Wiring Diagram

4-2 Wiring

4-3 Wiring Plate Diagram

4-4 Basic Waterproof Component Wiring Diagram

After removing the front cover, please check if the power and control terminals are clearly noted. Please read following precautions before wiring.



- ☑ It is crucial to turn off the AC motor drive power before any wiring installations are made. A charge may still remain in the DC bus capacitors with hazardous voltages even if the power has been turned off. Therefore it is suggested for users to measure the remaining voltage by DC voltage meter before wiring. For your personnel safety, please do not start any wiring before the voltage drops to a safe level < 25 VDC. Wiring installation with remaining voltage condition may cause sparks and short circuit.
- ☑ Only qualified personnel familiar with AC motor drives is allowed to perform installation, wiring and commissioning. Make sure the power is turned off before wiring to prevent electric shock.
- ☑ The main circuit terminals R/L1, S/L2, T/L3 are for power input. If the power is wrongly connected to others terminals, it may result in damage to the equipment. The voltage and current should lie within the range as indicated on the nameplate (Chapter 1-1).
- ☑ All the units must be grounded directly to a common ground terminal to prevent lightning strike or electric shock.
- ☑ Please make sure to tighten the screw of the main circuit terminals to prevent sparks which is made by the loose screws due to vibration



- ☑ When wiring, please choose the wires with specification that complies with local regulation for your personnel safety.
- ☑ Check following items after finishing the wiring:
 1. Are all connections correct?
 2. Any loosen wires?
 3. Any short-circuits between the terminals or to ground?

4-1 System Wiring Diagram

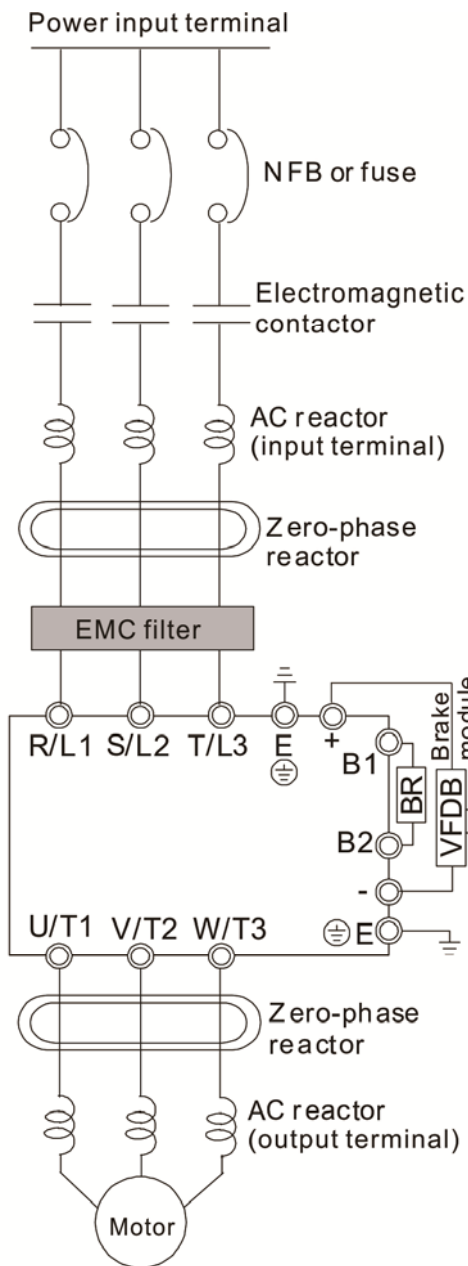

Power input terminal	Please refer to Chapter 9 Specification Table in user manual for detail
NFB or fuse	There may be a large inrush current during power on. Refer to 7-2 NFB to select a suitable NFB or 7-3 Fuse Specification Chart.
Electromagnetic contactor	Switching the power ON/OFF before the magnetic contactor more than 1xper hour can cause damage to the drive.
AC reactor (input terminal)	When the mains power capacity is > 500kVA or when the drive is preceded by a capacitor bank, instantaneous peaks voltages and current may destroy the drive. In that case it is recommended to install an AC input reactor which will also improve the power factor and harmonics. The cable between reactor and drive should be < 10m. Please refer to Chapter 7-4.
Zero-phase reactor	Used to reduce radiated emission, especially in environments with audio devices, and reduce input and output side interference. The effective range is AM band to 10MHz. Please refer to Chapter 7-5.
EMC filter	Can be used to reduce electromagnetic interference. Please refer to Chapter 7-6.
Brake module & Brake resistor(BR)	Used to shorten the deceleration time of the motor. Please refer to Chapter 7-1.
AC reactor (output terminal)	The motor cable length will affect switching current peaks. It is recommended to install an AC output reactor when the motor cable length exceeds the value in Chapter 7-4.

4-2 Wiring

Wiring Diagram for Frame A~C

Input: 3-phase power

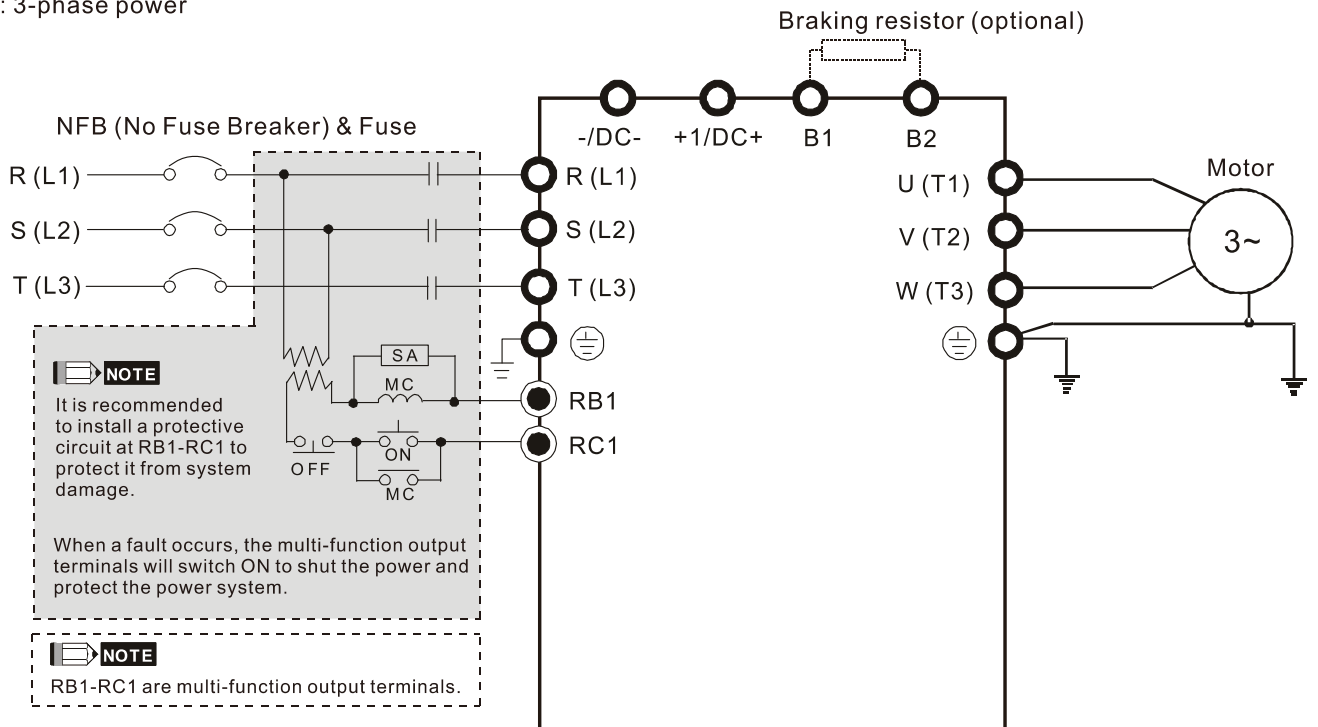

Wiring Diagram for Frame D0~D

Input: 3-phase power

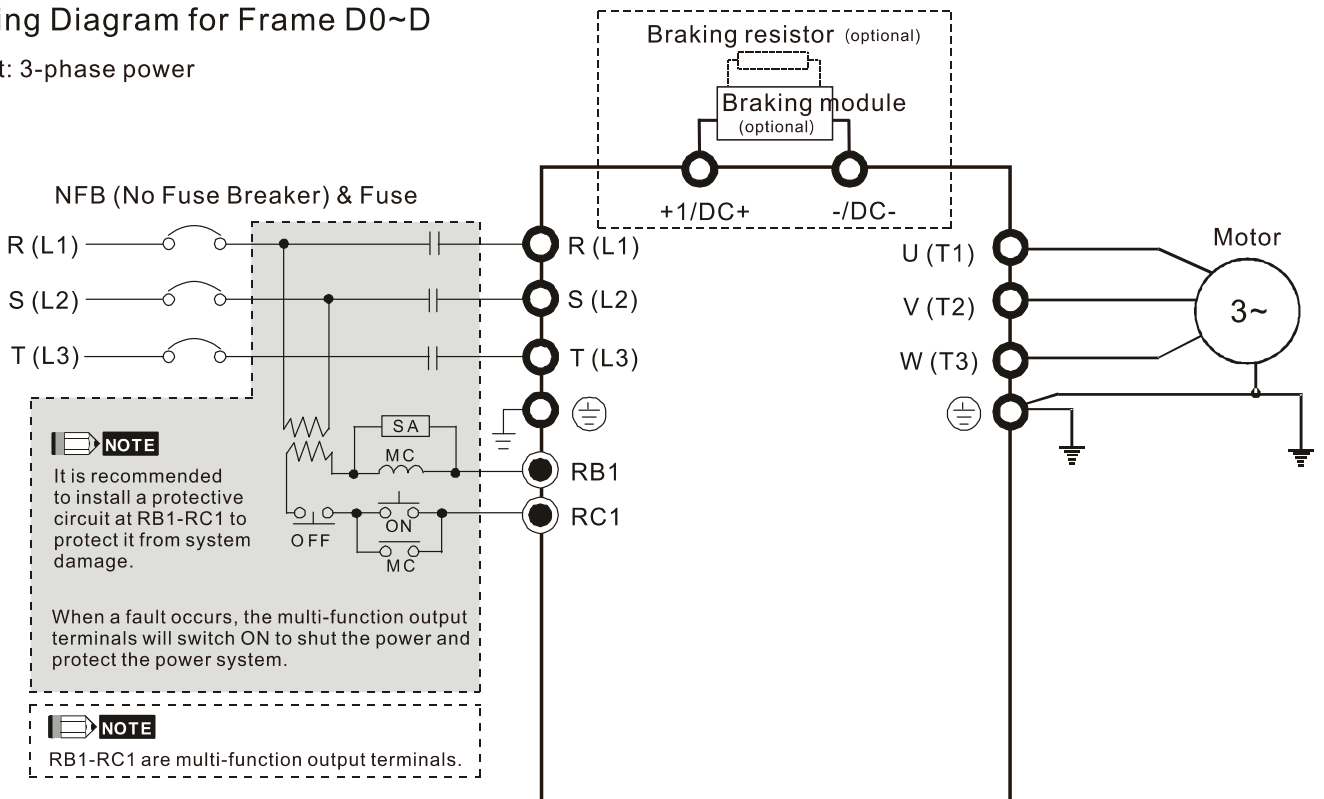

Wiring Diagram for Frame A~H

Input: 3-phase power

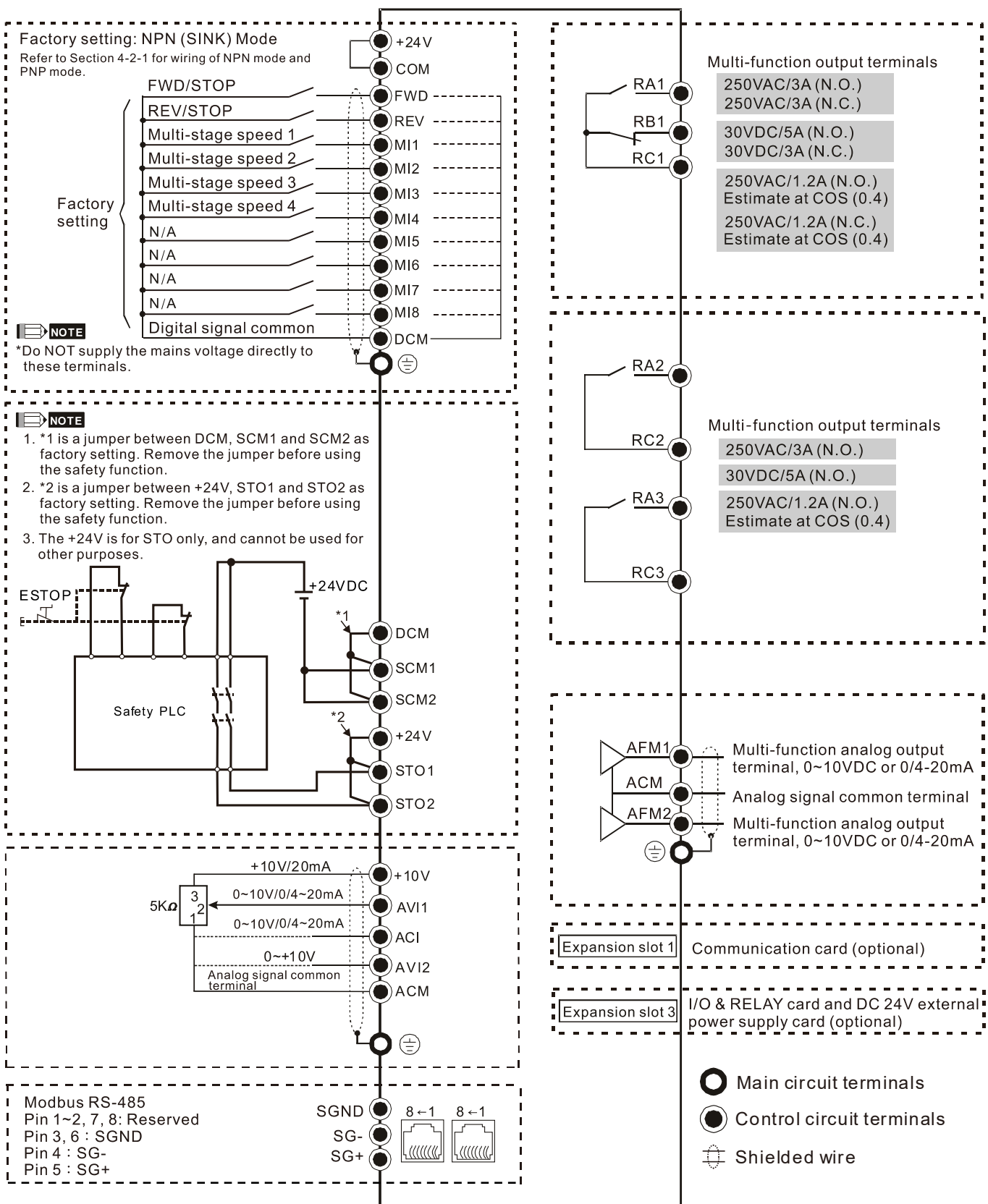

4-2-1 SINK (NPN) / SOURCE (PNP) Mode

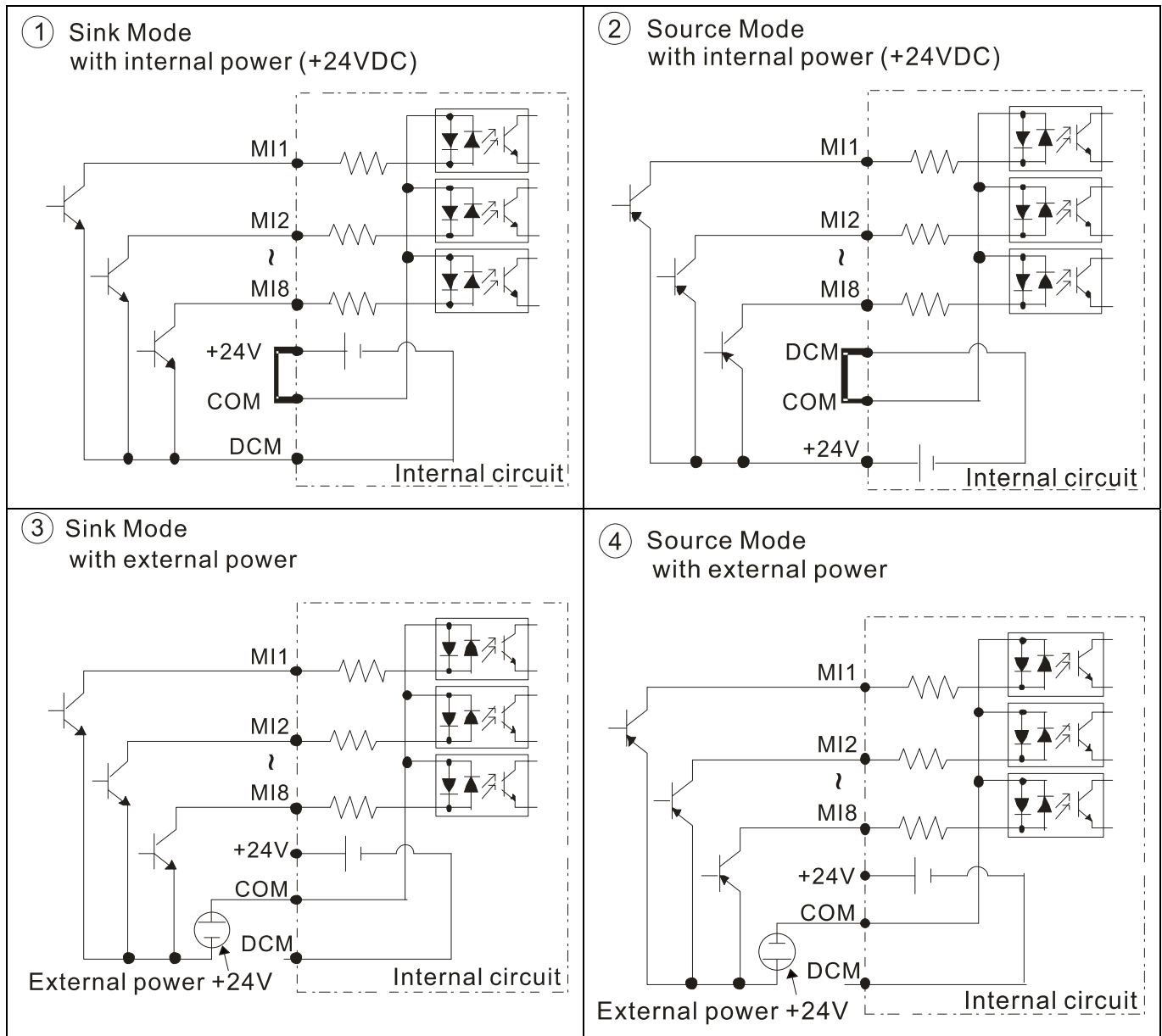

4-3 Wiring Plate Diagram

Frame A

Screw torque:
 1~4: [14~16kg-cm]
 5: [6~8kg-cm]

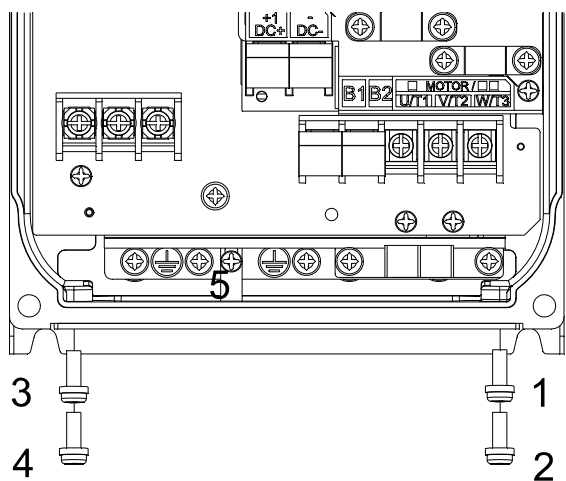

Frame B

Screw torque:
 1~4: [14~16kg-cm]
 5: [6~8kg-cm]

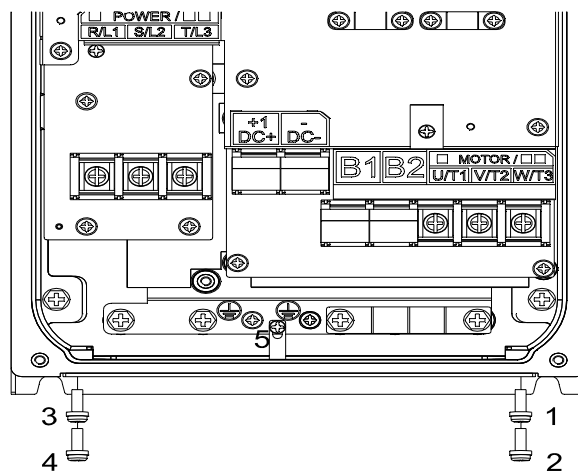

Frame C

Screw torque:
 1~6: [12~15kg-cm]
 7~8: [12~15kg-cm]

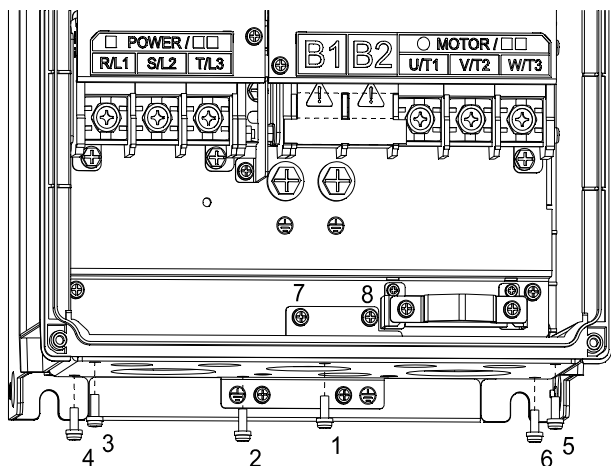

4-4 Basic Waterproof Component Wiring Diagram

Frame A

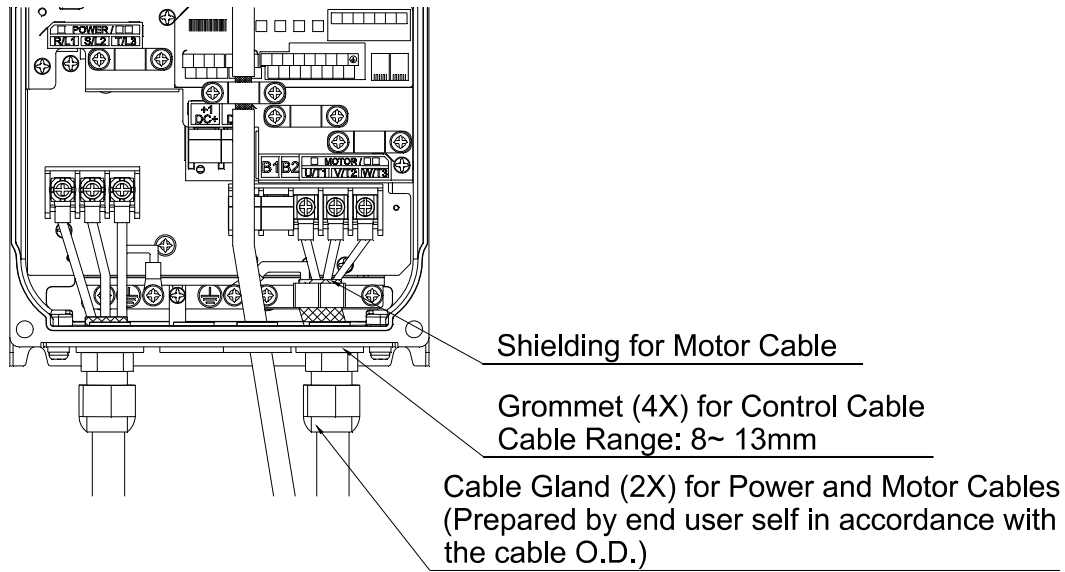

Frame B

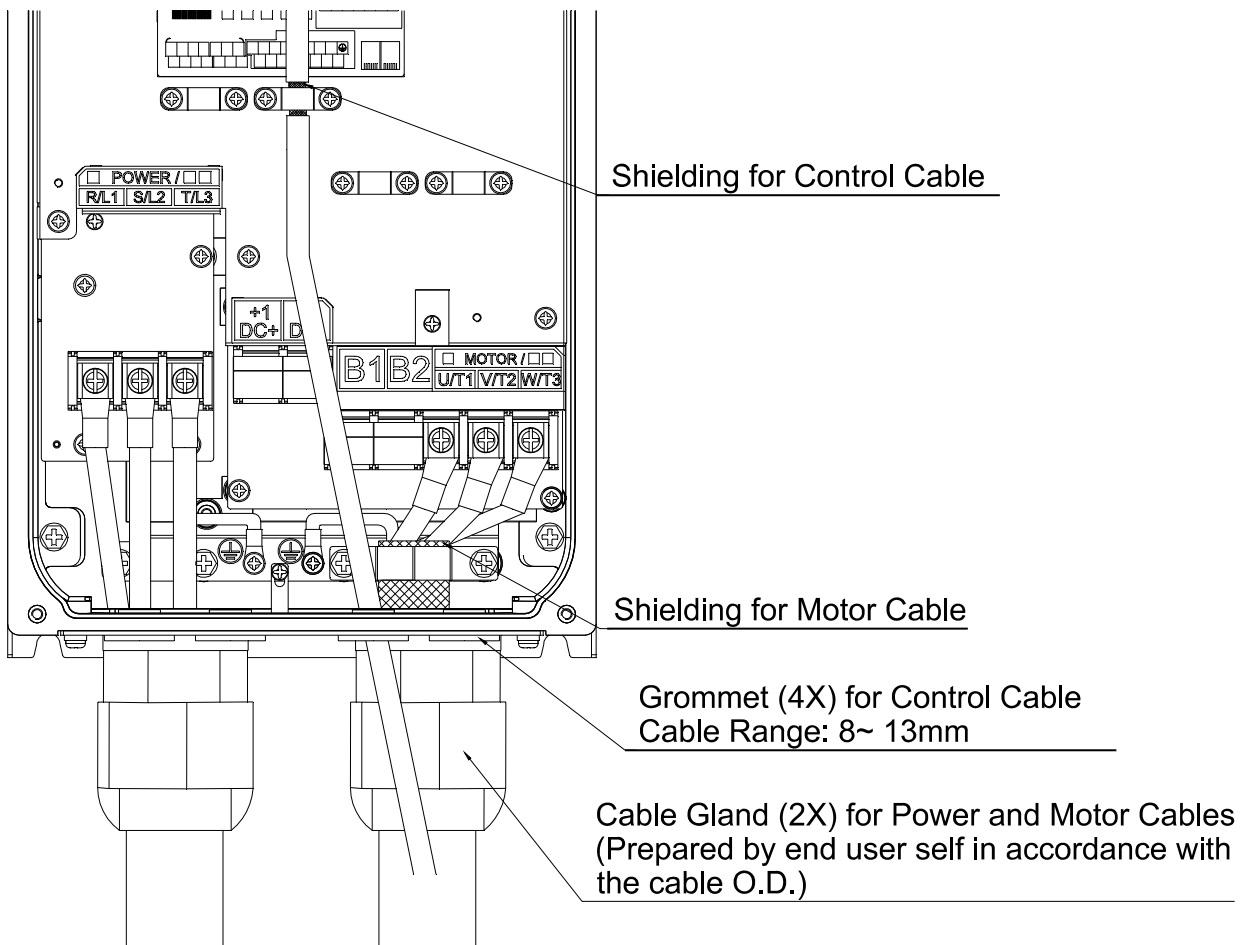

Frame C/D0

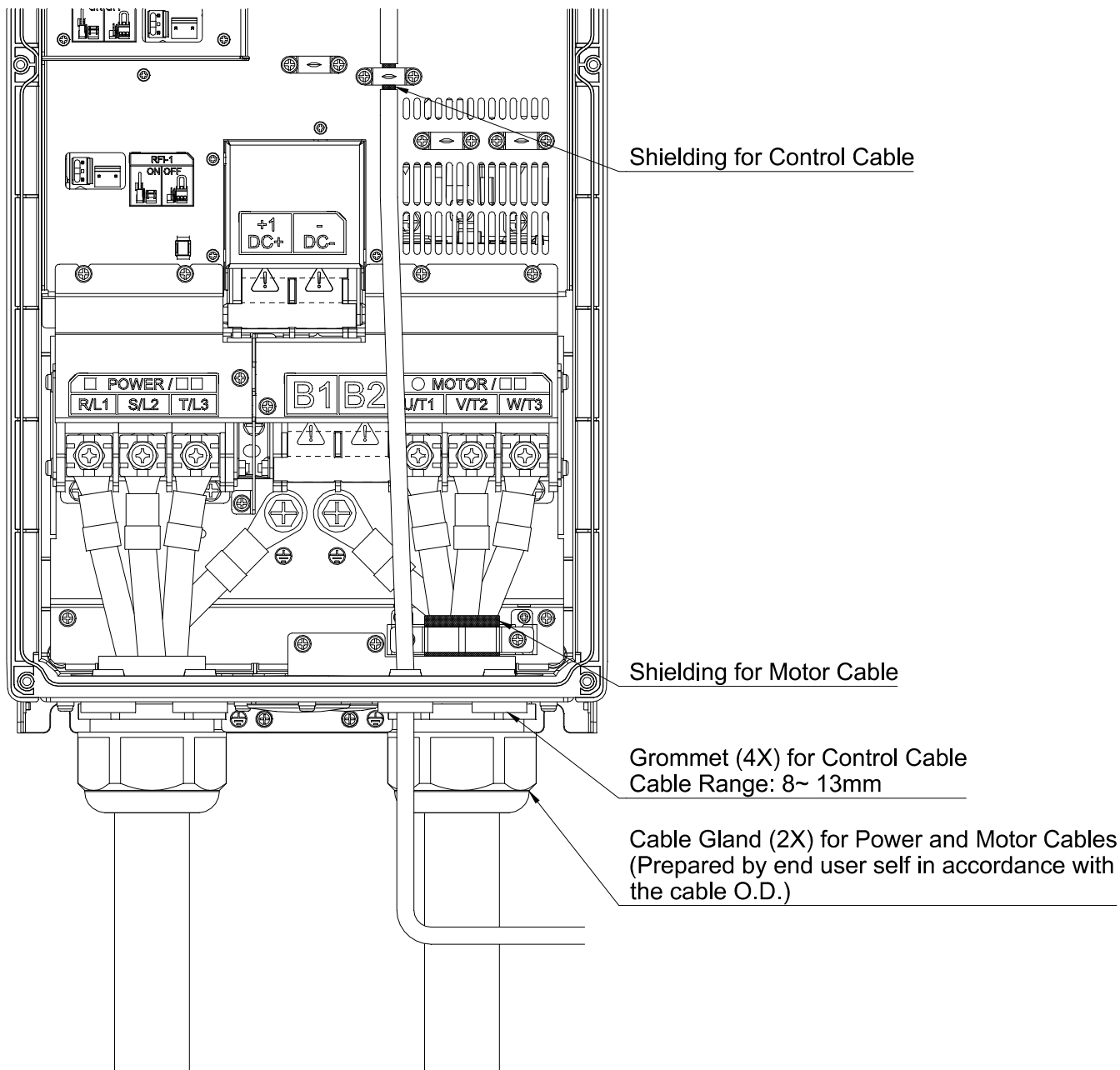

Frame D

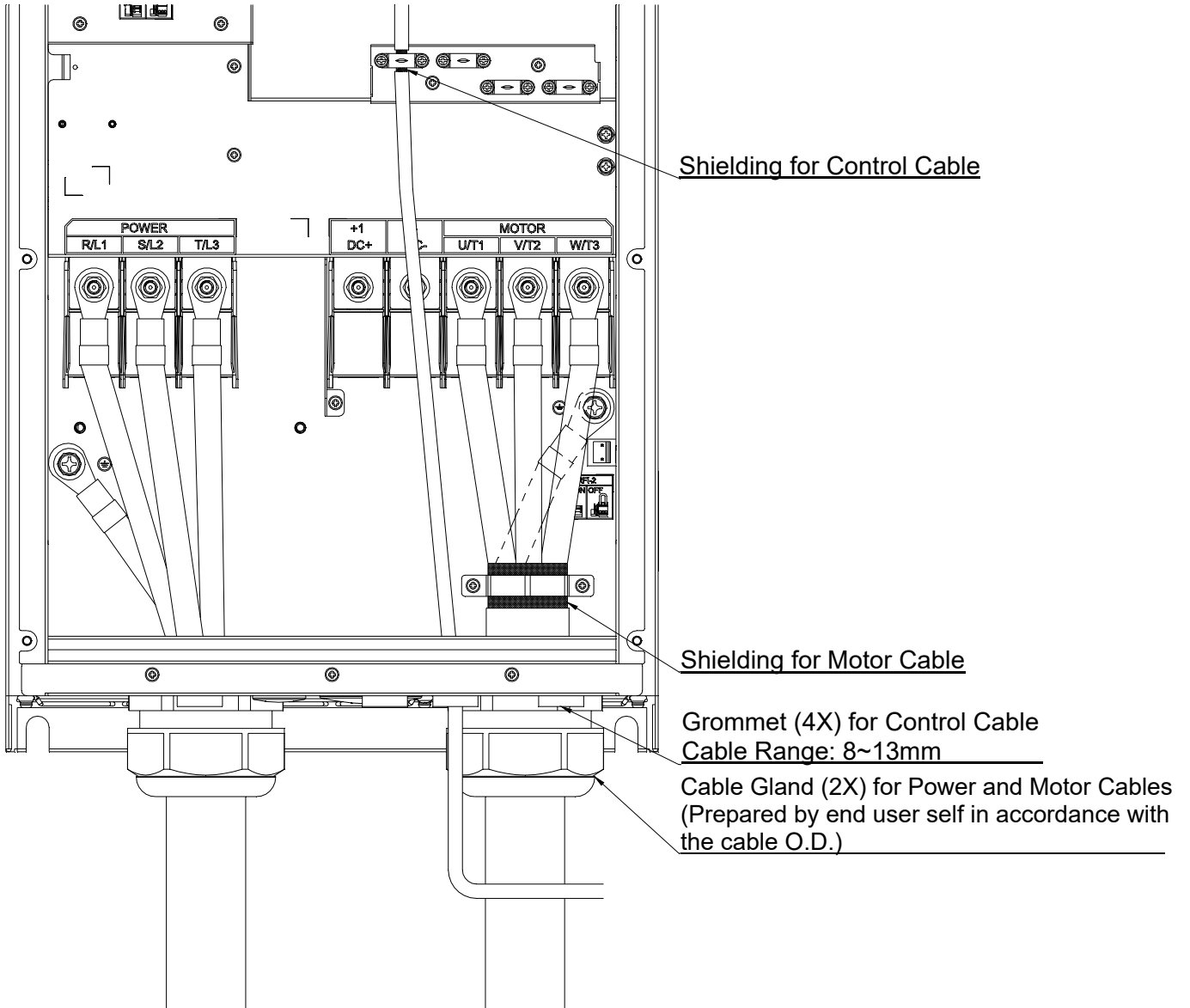

Chapter 5 Main Circuit Terminals

5-1 Main Circuit Diagram

5-2 Main Circuit Terminals



Main power terminals

- ☑ Do not connect 3-phase model to one-phase power. R/L1, S/L2 and T/L3 has no phase-sequence requirement, it can be used upon random selection.
- ☑ It is recommend adding a magnetic contactor (MC) to the power input wiring to cut off power quickly and reduce malfunction when activating the protection function of the AC motor drive. Both ends of the MC should have an R-C surge absorber.
- ☑ Please use voltage and current within the specification.
- ☑ When using a general GFCI (Ground Fault Circuit Interrupter), select a current sensor with sensitivity of 200mA or above and not less than 0.1-second operation time to avoid nuisance tripping.
- ☑ Please use the shield wire or tube for the power wiring and ground the two ends of the shield wire or tube.
- ☑ Do NOT run/stop AC motor drives by turning the power ON/OFF. Run/stop AC motor drives by RUN/STOP command via control terminals or keypad. If you still need to run/stop AC motor drives by turning power ON/OFF, it is recommended to do so only ONCE per hour.
- ☑ Connect the drive to a 3-phase three-wire or 3-phase four-wire Wye system to comply with UL standards.

Output terminals for main circuit

- ☑ Use well-insulated motor, suitable for inverter operation.
- ☑ When the AC drive output terminals U/T1, V/T2, and W/T3 are connected to the motor terminals U/T1, V/T2, and W/T3, respectively, the motor will rotate counterclockwise (as viewed on the shaft end of the motor) when a forward operation command is received. To permanently reverse the direction of motor rotation, switch over any of the two motor leads

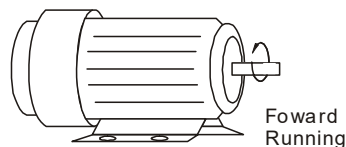

Terminals for connecting DC reactor, external brake resistor, external brake resistor and DC circuit

- ☑ Connect a brake resistor or brake unit in applications with frequent deceleration ramps, short deceleration time, too low brake torque or requiring increased brake torque.

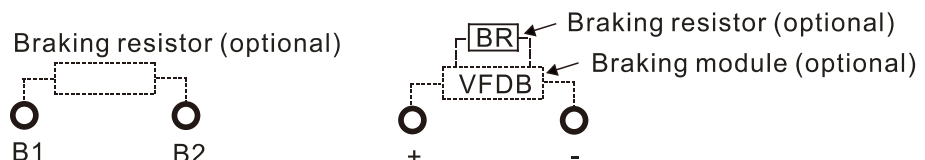

- ☑ The external brake resistor of Frame A, B and C should connect to the terminals (B1, B2) of AC motor drives.
- ☑ For those models without built-in brake resistor, please connect external brake unit and brake resistor (both of them are optional) to increase brake torque.

-
- | |
|--|
| <ul style="list-style-type: none"><li data-bbox="400 118 1474 201">☑ When the terminals +1/DC+, -/DC- are not used, please leave the terminals open.<li data-bbox="400 212 1474 347">☑ DC+ and DC- are connected by common DC bus, please refer to Chapter 5-1(Main Circuit Terminal) for the wiring terminal specification and the wire gauge information.<li data-bbox="400 358 1474 445">☑ Please refer to the VFDB manual for more information on wire gauge when installing the brake unit. |
|--|
-

5-1 Main Circuit Diagram

Wiring Diagram for Frame A~C

Input: 3-phase power

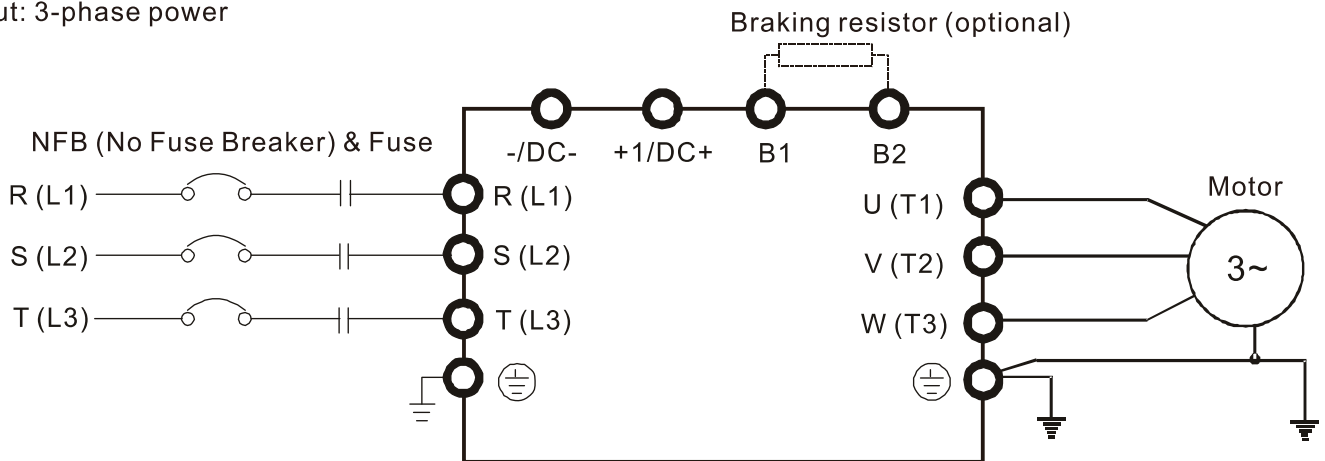

Wiring Diagram for Frame D0~D

Input: 3-phase power

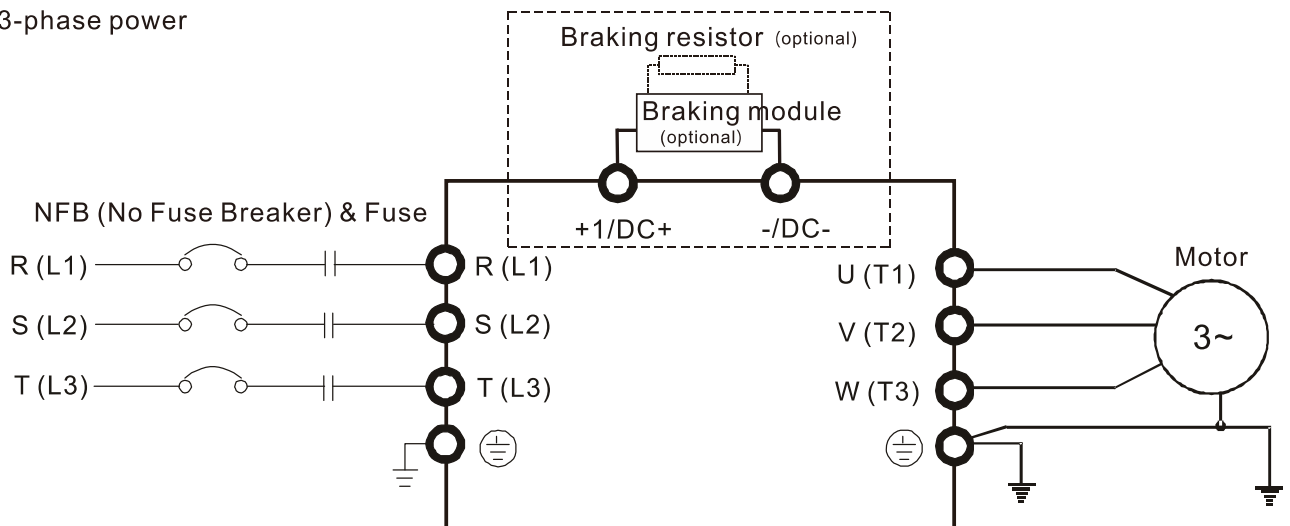

Terminals	Descriptions
R/L1, S/L2, T/L3	AC line input terminals 3-phase
U/T1, V/T2, W/T3	AC drive output terminals for connecting 3-phase induction motor
+1/DC+, -/DC-	Connections for brake unit (VFDB series) ($\leq 30\text{kW}$, built-in brake unit) Common DC Bus
B1, B2	Connections for brake resistor (optional)
⊕	Earth connection, please comply with local regulations.

5-2 Main Circuit Terminals

Frame A-1 / A-3

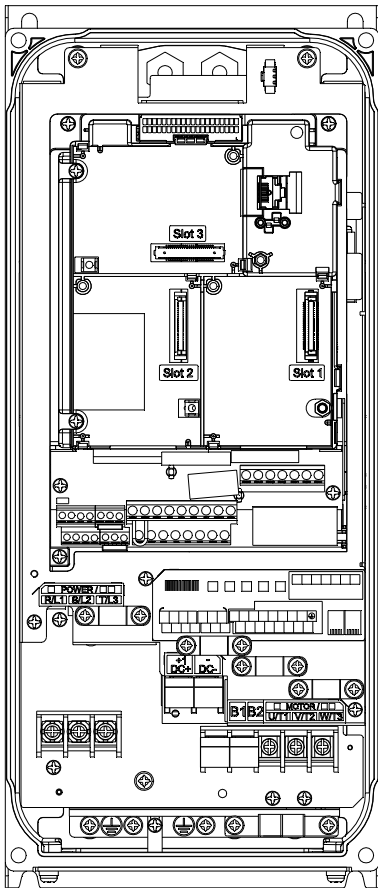

Main circuit terminals:

- If you install at Ta 40°C above environment, please select copper wire which have voltage rating 600V and temperature resistant 90°C or above.
- If you install at Ta 40°C environment, please select copper wire which have voltage rating 600V and temperature resistant 75°C or 90°C.
- For UL installation compliant, you have to use copper wires when installation, the wire gauge is based on temperature resistant 75°C which is according to the requirements and recommendations from UL. Do not reduce the wire gauge when using higher temperature wire.

R/L1, S/L2, T/L3, U/T1, V/T2, W/T3, B1, B2

Models	Max. Wire Gauge	Min. Wire Gauge	Torque (±10%)	
VFD007FP4EA-41/52	10 AWG [5.3mm ²]	12 AWG [3.3mm ²]	M3.5 10kg-cm [8.7 lb-in.] [0.98Nm]	
VFD015FP4EA-41/52			10AWG [5.3mm ²]	M4.0 18kg-cm [15.6 lb-in.] [1.77Nm]
VFD022FP4EA-41/52				
VFD037FP4EA-41/52				
VFD040FP4EA-41/52				
VFD055FP4EA-41/52				
VFD075FP4EA-41/52				

⊕ · DC- · DC+

Models	Max. Wire Gauge	Min. Wire Gauge	Torque (±10%)		
VFD007FP4EA-41/52	10 AWG [5.3mm ²]	12 AWG [3.3mm ²]	M4.0 18kg-cm [15.6 lb-in.] [1.77Nm]		
VFD015FP4EA-41/52				10AWG [5.3mm ²]	
VFD022FP4EA-41/52					
VFD037FP4EA-41/52					
VFD040FP4EA-41/52					
VFD055FP4EA-41/52					
VFD075FP4EA-41/52					

- ☑ It needs following additional terminal when wiring. The additional terminal dimension should comply with the following figure 1.
- ☑ After crimping the wire to the ring lug (must UL approved), UL and CSA approved R/C(YDPU2) heat shrink tubing rated min 600VAC insulation shall be installed over the live part.

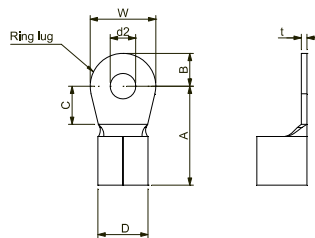

Figure 1.

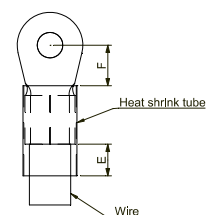
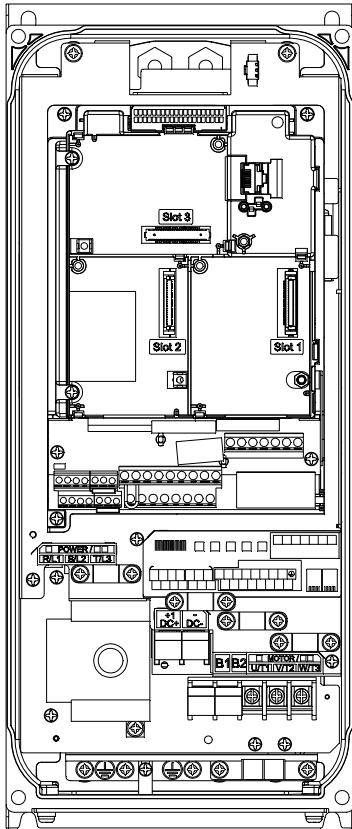

Figure 2.

A (MAX)	B (MAX)	C (min)	D (MAX)	d2 (min)	E (min)	F (min)	W (MAX)	T (MAX)
12.1	3.6	6.1	5.6	4.3	7.0	6.1	7.3	1.0

Unit: mm

Frame A-2



Main circuit terminals:

- If you install at Ta 40°C above environment, please select copper wire which have voltage rating 600V and temperature resistant 90°C or above.
- If you install at Ta 40°C environment, please select copper wire which have voltage rating 600V and temperature resistant 75°C or 90°C.
- For UL installation compliant, you have to use copper wires when installation, the wire gauge is based on temperature resistant 75°C which is according to the requirements and recommendations from UL. Do not reduce the wire gauge when using higher temperature wire.

R/L1, S/L2, T/L3

Models	Max. Wire Gauge	Min. Wire Gauge	Torque (±10%)
VFD007FP4EA-52S	10 AWG [5.3mm ²]	12 AWG [3.3mm ²]	8kg-cm [6.9lb-in.] [0.78Nm]
VFD015FP4EA-52S			
VFD022FP4EA-52S			
VFD037FP4EA-52S		10AWG [5.3mm ²]	
VFD040FP4EA-52S			
VFD055FP4EA-52S			
VFD075FP4EA-52S			

U/T1, V/T2, W/T3, B1, B2

Models	Max. Wire Gauge	Min. Wire Gauge	Torque (±10%)
VFD007FP4EA-52S	10 AWG [5.3mm ²]	12 AWG [3.3mm ²]	M3.5 10kg-cm [8.7 lb-in.] [0.98Nm]
VFD015FP4EA-52S			
VFD022FP4EA-52S			
VFD037FP4EA-52S		10AWG [5.3mm ²]	M4.0 18kg-cm [15.6 lb-in.] [1.77Nm]
VFD040FP4EA-52S			
VFD055FP4EA-52S			
VFD075FP4EA-52S			

⊖ · DC- · DC+

Models	Max. Wire Gauge	Min. Wire Gauge	Torque (±10%)
VFD007FP4EA-52S	10 AWG [5.3mm ²]	12 AWG [3.3mm ²]	M4.0 18kg-cm [15.6 lb-in.] [1.77Nm]
VFD015FP4EA-52S			
VFD022FP4EA-52S			
VFD037FP4EA-52S		10AWG [5.3mm ²]	
VFD040FP4EA-52S			
VFD055FP4EA-52S			
VFD075FP4EA-52S			

- ☑ It needs following additional terminal when wiring. The additional terminal dimension should comply with the following figure 1.
- ☑ After crimping the wire to the ring lug (must UL approved), UL and CSA approved R/C(YDPU2) heat shrink tubing rated min 600VAC insulation shall be installed over the live part.

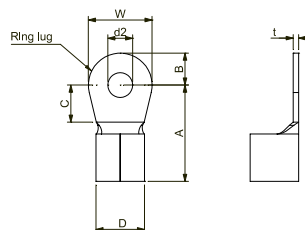

Figure 1.

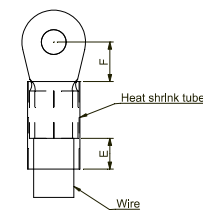
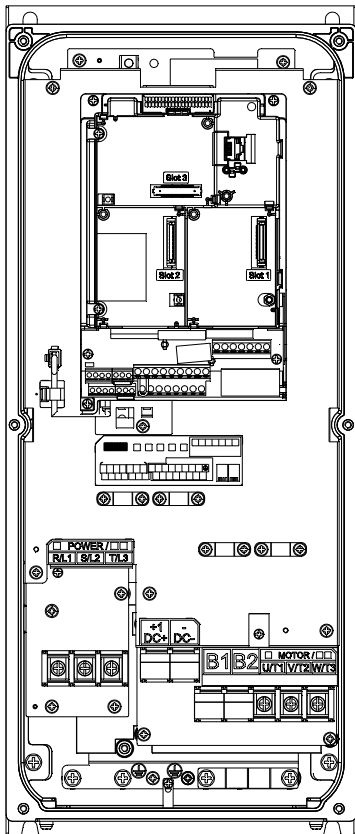

Figure 2.

A (MAX)	B (MAX)	C (min)	D (MAX)	d2 (min)	E (min)	F (min)	W (MAX)	T (MAX)
12.1	3.6	6.1	5.6	4.3	7.0	6.1	7.3	1.0

Unit: mm

Frame B-1 / B-3



Main circuit terminals:

- If you install at Ta 40°C above environment, please select copper wire which have voltage rating 600V and temperature resistant 90°C or above.
- If you install at Ta 40°C environment, please select copper wire which have voltage rating 600V and temperature resistant 75°C or 90°C.
- For UL installation compliant, you have to use copper wires when installation, the wire gauge is based on temperature resistant 75°C which is according to the requirements and recommendations from UL. Do not reduce the wire gauge when using higher temperature wire.

R/L1, S/L2, T/L3, U/T1, V/T2, W/T3, ⊕, B1, B2, DC-,DC+

Models	Max. Wire Gauge	Min. Wire Gauge	Torque (±10%)
VFD110FP4EA-41/52	6 AWG [13.3mm ²]	8 AWG [8.4mm ²]	M5 25kg-cm [21.7 lb-in.] [2.45Nm]
VFD150FP4EA-41/52			
VFD185FP4EA-41/52		6 AWG [13.3mm ²]	
VFD220FP4EA-41/52			

- ☑ It needs following additional terminal when wiring. The additional terminal dimension should comply with the following figure 1.
- ☑ After crimping the wire to the ring lug (must UL approved), UL and CSA approved R/C(YDPU2) heat shrink tubing rated min 600VAC insulation shall be installed over the live part.

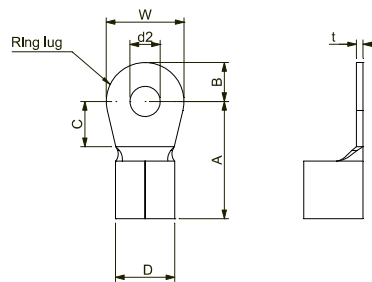

Figure 1.

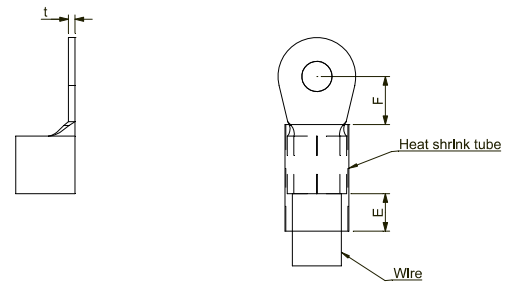
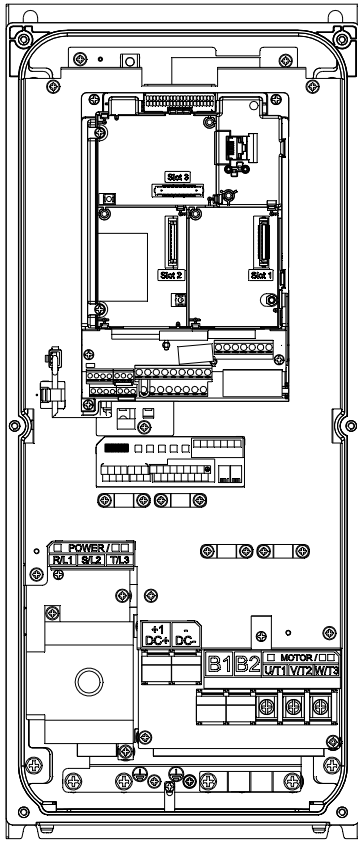

Figure 2.

A (MAX)	B (MAX)	C (min)	D (MAX)	d2 (min)	E (min)	F (min)	W (MAX)	T (MAX)
23.8	6.0	13.3	9.0	5.3	11.0	13.3	12.0	1.5

Unit: mm

Frame B-2



Main circuit terminals:

- If you install at Ta 40°C above environment, please select copper wire which have voltage rating 600V and temperature resistant 90°C or above.
- If you install at Ta 40°C environment, please select copper wire which have voltage rating 600V and temperature resistant 75°C or 90°C.
- For UL installation compliant, you have to use copper wires when installation, the wire gauge is based on temperature resistant 75°C which is according to the requirements and recommendations from UL. Do not reduce the wire gauge when using higher temperature wire.

R/L1, S/L2, T/L3

Models	Max. Wire Gauge	Min. Wire Gauge	Torque (±10%)
VFD110FP4EA-52S	6 AWG [13.3mm ²]	8 AWG [8.4mm ²]	21kg-cm [18.2lb-in.] [2.06Nm]
VFD150FP4EA-52S			
VFD185FP4EA-52S		6 AWG [13.3mm ²]	
VFD220FP4EA-52S			

U/T1, V/T2, W/T3, B1, B2, ⊕ · -/DC- · +1/DC+

Models	Max. Wire Gauge	Min. Wire Gauge	Torque (±10%)
VFD110FP4EA-52S	6 AWG [13.3mm ²]	8 AWG [8.4mm ²]	M5.0 25kg-cm [21.7lb-in.] [2.45Nm]
VFD150FP4EA-52S			
VFD185FP4EA-52S		6 AWG [13.3mm ²]	
VFD220FP4EA-52S			

- ☑ It needs following additional terminal when wiring. The additional terminal dimension should comply with the following figure 1.
- ☑ After crimping the wire to the ring lug (must UL approved), UL and CSA approved R/C(YDPU2) heat shrink tubing rated min 600VAC insulation shall be installed over the live part.

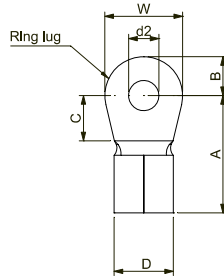

Figure 1.

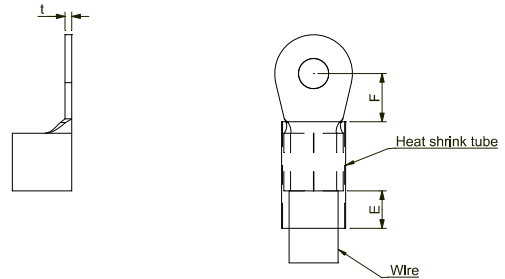
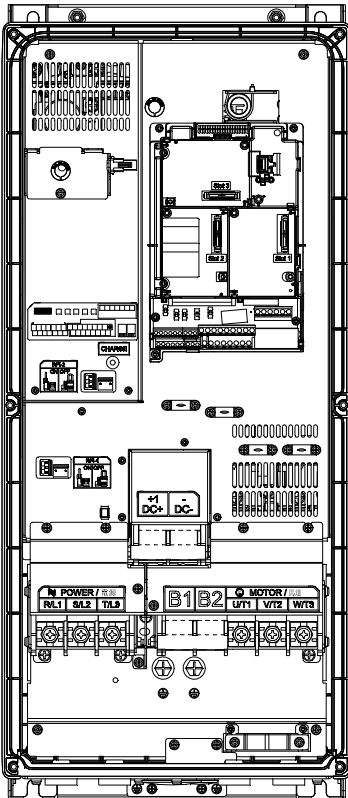

Figure 2.

A (MAX)	B (MAX)	C (min)	D (MAX)	d2 (min)	E (min)	F (min)	W (MAX)	T (MAX)
23.8	6.0	13.3	9.0	5.3	11.0	13.3	12.0	1.5

Unit: mm

Frame C-1 / C-3



Main circuit terminals:

- If you install at Ta 40°C above environment, please select copper wire which have voltage rating 600V and temperature resistant 90°C or above.
- If you install at Ta 40°C environment, please select copper wire which have voltage rating 600V and temperature resistant 75°C or 90°C.
- For UL installation compliant, you have to use copper wires when installation, the wire gauge is based on temperature resistant 75°C which is according to the requirements and recommendations from UL. Do not reduce the wire gauge when using higher temperature wire.

R/L1, S/L2, T/L3, U/T1, V/T2, W/T3, ⊕, B1, B2, -/DC-, +1/DC+

Models	Max. Wire Gauge	Min. Wire Gauge	Torque (±10%)
VFD300FP4EA-41/52	2 AWG [33.6mm ²]	4 AWG [21.2mm ²]	M8 81.6kg-cm [70.8 lb-in.] [8.00Nm]
VFD370FP4EA-41/52		2 AWG [33.6mm ²]	

UL installations must use 600V, 90°C wire. Use copper wire only.

- ☑ It needs following additional terminal when wiring. The additional terminal dimension should comply with the following figure 1.
- ☑ After crimping the wire to the ring lug (must UL approved), UL and CSA approved R/C(YDPU2) heat shrink tubing rated min 600VAC insulation shall be installed over the live part.

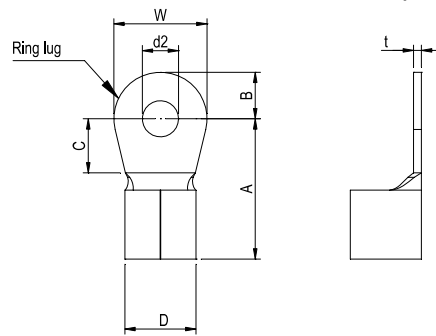

Figure 1

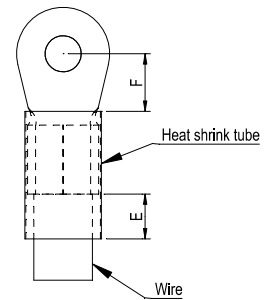
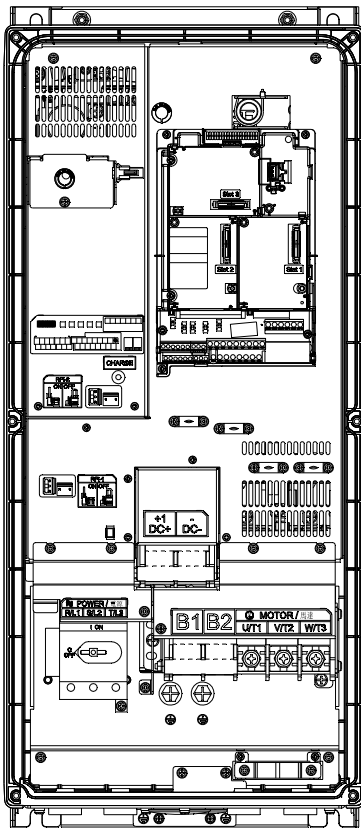

Figure 2

A (MAX)	B (MAX)	C (min)	D (MAX)	d2 (min)	E (min)	F (min)	W (MAX)	T (MAX)
40	10	10	15	8.3	13	12	22	2.5

Unit: mm

Frame C-2



Main circuit terminals:

- If you install at Ta 40°C above environment, please select copper wire which have voltage rating 600V and temperature resistant 90°C or above.
- If you install at Ta 40°C environment, please select copper wire which have voltage rating 600V and temperature resistant 75°C or 90°C.
- For UL installation compliant, you have to use copper wires when installation, the wire gauge is based on temperature resistant 75°C which is according to the requirements and recommendations from UL. Do not reduce the wire gauge when using higher temperature wire.

R/L1, S/L2, T/L3 (Stranded wire only)

Models	Max. Wire Gauge	Min. Wire Gauge	Torque (±10%)
VFD300FP4EA-52S	2 AWG [33.6mm ²]	4 AWG [21.2mm ²]	21kg-cm [18.2lb-in.] [2.06Nm]
VFD370FP4EA-52S		2 AWG [33.6mm ²]	

U/T1, V/T2, W/T3, ⊕, B1, B2, -/DC-, +1/DC+

Models	Max. Wire Gauge	Min. Wire Gauge	Torque (±10%)
VFD300FP4EA-52S	2 AWG [33.6mm ²]	4 AWG [21.2mm ²]	M8 81.6kg-cm [70.8 lb-in.] [8.00Nm]
VFD370FP4EA-52S		2 AWG [33.6mm ²]	

- ☑ It needs following additional terminal when wiring. The additional terminal dimension should comply with the following figure 1.
- ☑ After crimping the wire to the ring lug (must UL approved), UL and CSA approved R/C(YDPU2) heat shrink tubing rated min 600VAC insulation shall be installed over the live part.

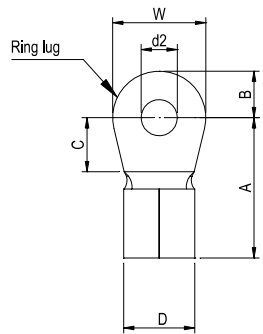

Figure 1

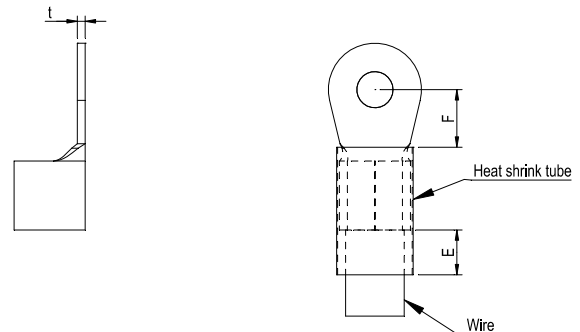
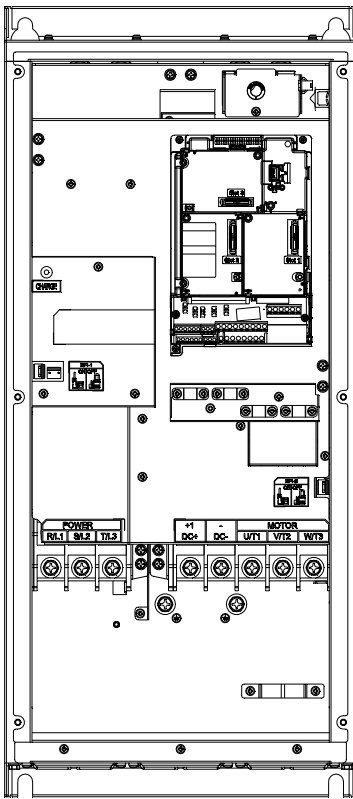

Figure 2

A (MAX)	B (MAX)	C (min)	D (MAX)	d2 (min)	E (min)	F (min)	W (MAX)	T (MAX)
40	10	10	15	8.3	13	12	22	2.5

Unit: mm

Frame D0-1 / D0-3



Main circuit terminals:

- If you install at Ta 35°C above environment, please select copper wire which have voltage rating 600V and temperature resistant 90°C or above.
- If you install at Ta 35°C environment, please select copper wire which have voltage rating 600V and temperature resistant 75°C or 90°C.
- For UL installation compliant, you have to use copper wires when installation, the wire gauge is based on temperature resistant 75°C which is according to the requirements and recommendations from UL. Do not reduce the wire gauge when using higher temperature wire.

R/L1, S/L2, T/L3, U/T1, V/T2, W/T3, \oplus , -/DC-, +1/DC+

Models	Max. Wire Gauge	Min. Wire Gauge	Torque ($\pm 10\%$)
VFD450FP4EA-41/52	1/0 AWG [53.5mm ²]	1 AWG [42.4mm ²]	M8
VFD550FP4EA-41/52		1/0 AWG [53.5mm ²]	81.6kg-cm [70.8 lb-in.] [8.00Nm]

- ☑ It needs following additional terminal when wiring. The additional terminal dimension should comply with the following figure 1.
- ☑ After crimping the wire to the ring lug (must UL approved), UL and CSA approved R/C(YDPU2) heat shrink tubing rated min 600VAC insulation shall be installed over the live part.

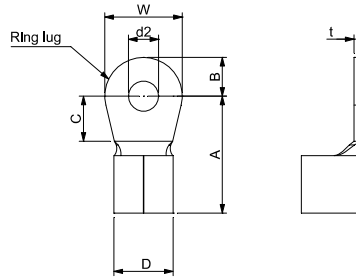

Figure 1.

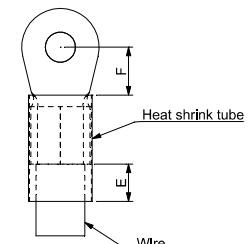
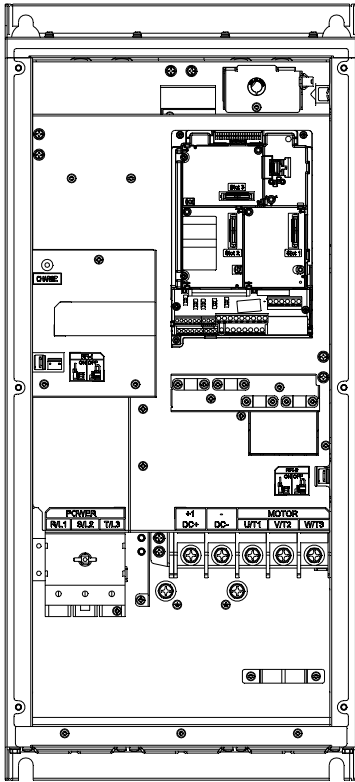

Figure 2.

A (MAX)	B (MAX)	C (min)	D (MAX)	d2 (min)	E (min)	F (min)	W (MAX)	t (MAX)
39	10.5	10	20	8.3	13	11.5	22	2.5

Unit: mm

Frame D0-2



Main circuit terminals:

- If you install at Ta 35°C above environment, please select copper wire which have voltage rating 600V and temperature resistant 90°C or above.
- If you install at Ta 35°C environment, please select copper wire which have voltage rating 600V and temperature resistant 75°C or 90°C.
- For UL installation compliant, you have to use copper wires when installation, the wire gauge is based on temperature resistant 75°C which is according to the requirements and recommendations from UL. Do not reduce the wire gauge when using higher temperature wire.

R/L1, S/L2, T/L3 (Stranded wire only)

Models	Max. Wire Gauge	Min. Wire Gauge	Torque (±10%)
VFD450FP4EA-52S	1/0 AWG [53.5mm ²]	1 AWG [42.4mm ²]	63.3kg-cm [55lb-in.] [6.20Nm]
VFD550FP4EA-52S		1/0 AWG [53.5mm ²]	

U/T1, V/T2, W/T3, ⊕, -/DC-, +1/DC+

Models	Max. Wire Gauge	Min. Wire Gauge	Torque (±10%)
VFD450FP4EA-52S	1/0 AWG [53.5mm ²]	1 AWG [42.4mm ²]	M8 81.6kg-cm [70.8 lb-in.] [8.00Nm]
VFD550FP4EA-52S		1/0 AWG [53.5mm ²]	

- ☑ It needs following additional terminal when wiring. The additional terminal dimension should comply with the following figure 1.
- ☑ After crimping the wire to the ring lug (must UL approved), UL and CSA approved R/C(YDPU2) heat shrink tubing rated min 600VAC insulation shall be installed over the live part.

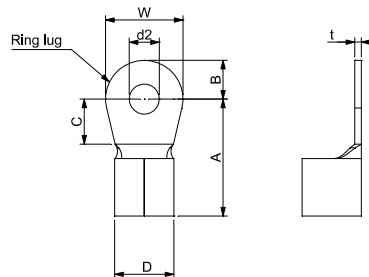

Figure 1.

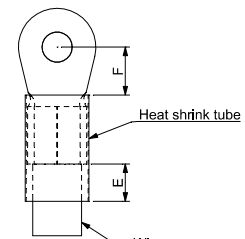
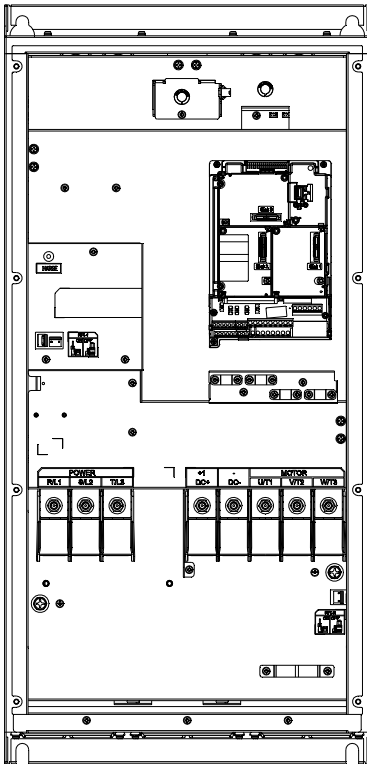

Figure 2.

A (MAX)	B (MAX)	C (min)	D (MAX)	d2 (min)	E (min)	F (min)	W (MAX)	t (MAX)
39	10.5	10	20	8.3	13	11.5	22	2.5

Unit: mm

Frame D-1 / D-3



Main circuit terminals:

- If you install at Ta 30°C above environment, please select copper wire which have voltage rating 600V and temperature resistant 90°C or above.
- If you install at Ta 30°C environment, please select copper wire which have voltage rating 600V and temperature resistant 75°C or 90°C.
- For UL installation compliant, you have to use copper wires when installation, the wire gauge is based on temperature resistant 75°C which is according to the requirements and recommendations from UL. Do not reduce the wire gauge when using higher temperature wire.

R/L1, S/L2, T/L3, U/T1, V/T2, W/T3, ⊕, -DC-, +1/DC+

Models	Max. Wire Gauge	Min. Wire Gauge	Torque (±10%)
VFD750FP4EA-41/52	4/0 AWG [107mm ²]	3/0AWG [85mm ²]	M8 200kg-cm [173 lb-in.] [19.62Nm]
VFD900FP4EA-41/52		4/0AWG [107mm ²]	

- ☑ It needs following additional terminal when wiring. The additional terminal dimension should comply with the following figure 1.
- ☑ After crimping the wire to the ring lug (must UL approved), UL and CSA approved R/C(YDPU2) heat shrink tubing rated min 600VAC insulation shall be installed over the live part.

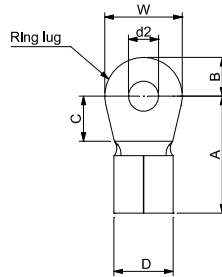

Figure 1.

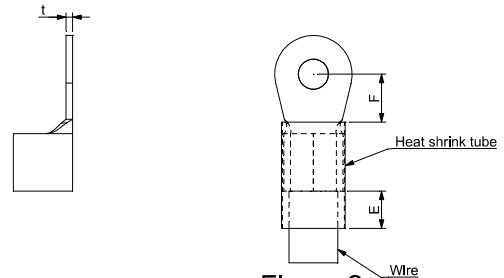
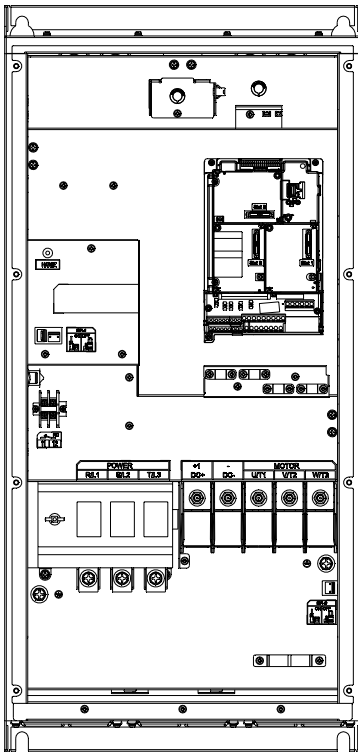

Figure 2.

A (MAX)	B (MAX)	C (min)	D (MAX)	d2 (min)	E (min)	F (min)	W (MAX)	t (MAX)
42	12	10	23	8.3	13	14	23	3.5

Unit: mm

Frame D-2



Main circuit terminals:

- If you install at Ta 30°C above environment, please select copper wire which have voltage rating 600V and temperature resistant 90°C or above.
- If you install at Ta 30°C environment, please select copper wire which have voltage rating 600V and temperature resistant 75°C or 90°C.
- For UL installation compliant, you have to use copper wires when installation, the wire gauge is based on temperature resistant 75°C which is according to the requirements and recommendations from UL. Do not reduce the wire gauge when using higher temperature wire.

R/L1, S/L2, T/L3

Models	Max. Wire Gauge	Min. Wire Gauge	Torque (±10%)
VFD750FP4EA-52S	4/0 AWG [107mm ²]	3/0AWG [85mm ²]	M8 200kg-cm [173 lb-in.] [19.62Nm]
VFD900FP4EA-52S		4/0AWG [107mm ²]	

U/T1, V/T2, W/T3, ⊕, -/DC-, +1/DC+

Models	Max. Wire Gauge	Min. Wire Gauge	Torque (±10%)
VFD750FP4EA-52S	4/0 AWG [107mm ²]	3/0AWG [85mm ²]	M8 200kg-cm [173 lb-in.] [19.62Nm]
VFD900FP4EA-52S		4/0AWG [107mm ²]	

- ☑ It needs following additional terminal when wiring. The additional terminal dimension should comply with the following figure 1.
- ☑ After crimping the wire to the ring lug (must UL approved), UL and CSA approved R/C(YDPU2) heat shrink tubing rated min 600VAC insulation shall be installed over the live part.

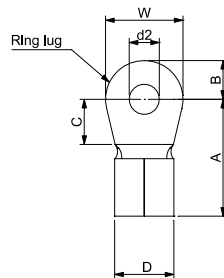

Figure 1.

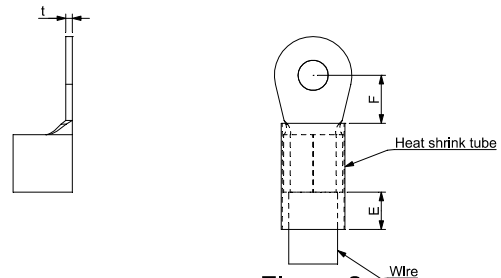

Figure 2.

A (MAX)	B (MAX)	C (min)	D (MAX)	d2 (min)	E (min)	F (min)	W (MAX)	t (MAX)
42	12	10	23	8.3	13	14	23	3.5

Unit: mm

Chapter 6 Control Terminals

6-1 Remove the Cover for Wiring

6-2 Specifications of Control Terminal

6-3 Remove the Terminal Block



Analog input terminals (AVI1, AVI2, ACI, ACM)

- ☑ Analog input signals are easily affected by external noise. Use shielded wiring and keep it as short as possible (<20m) with proper grounding. If the noise is inductive, connecting the shield to terminal ACM can bring improvement.
- ☑ When using analog input signal in the circuit, twisted pair is suggested to use for dealing with weak signal.
- ☑ If the analog input signals are affected by noise from the AC motor drive, please connect a capacitor and ferrite core as indicated in the following diagram.

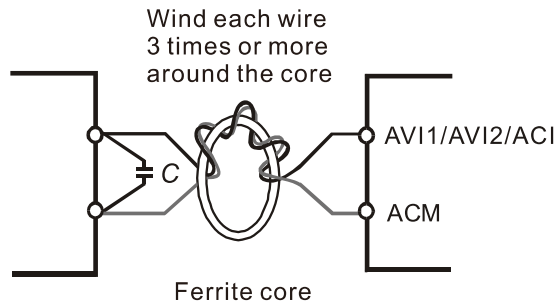

Digital inputs (FWD, REV, MI1~MI8, COM)

- ☑ When using contacts or switches to control the digital inputs, please use high quality components to avoid contact bounce.
- ☑ The “COM” terminal is the common side of the photo-coupler. Any of wiring method, the “common point” of all photo-coupler must be the “COM”.

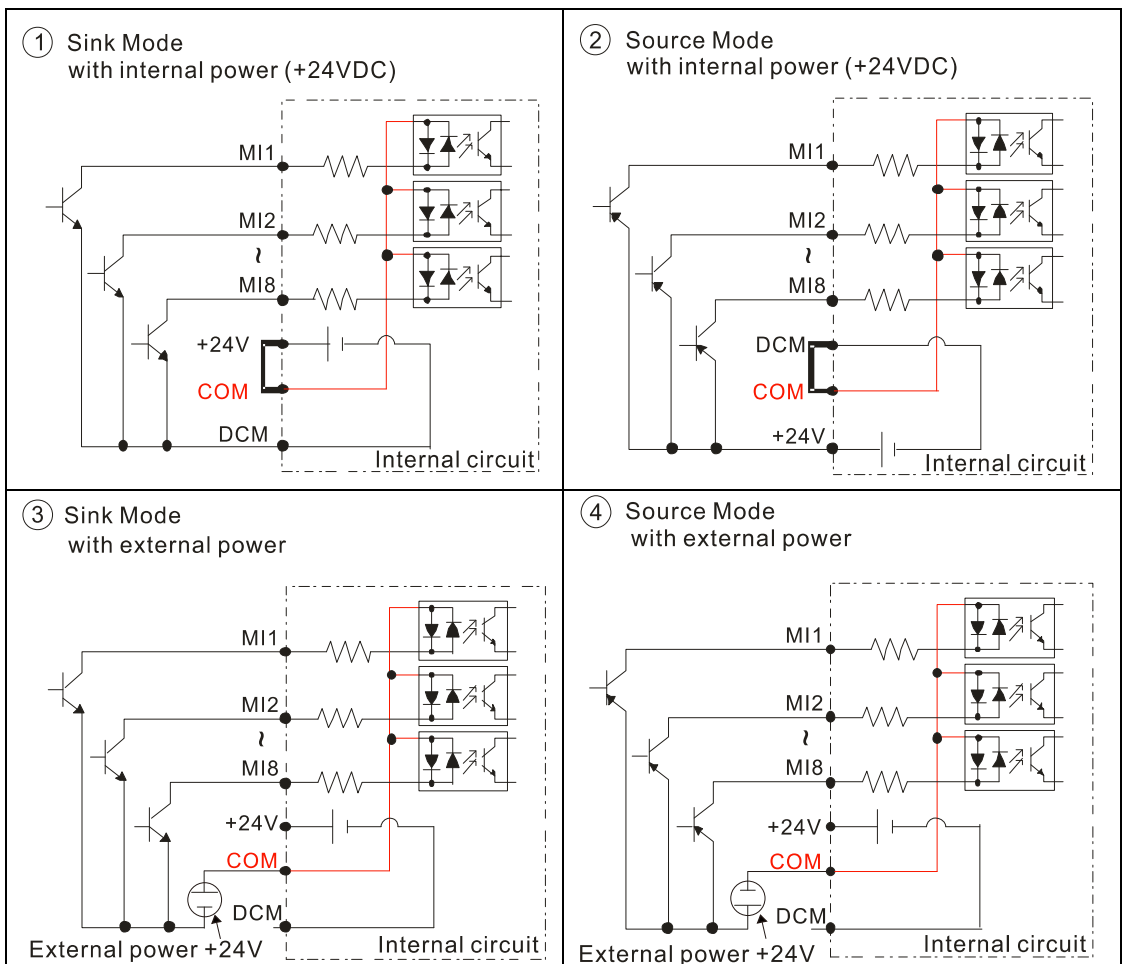

-
- ☑ When the photo-coupler is using internal power supply, the switch connection for Sink and Source as below:
 - “MI” links to “DCM”: Sink mode
 - “MI” links to “+24V”: Source mode
 - ☑ When the photo-coupler is using external power supply, please remove the short circuit cable between the +24V and COM terminals. The connection mode is Sink mode or Source mode is according to the below:
 - The “+” of 24V connecting to “COM: Sink mode
 - The “-“ of 24V connecting to COM: Source mode
-

6-1 Remove the cover for wiring

Please remove the top cover before wiring the multi-function input and output terminals,

 **NOTE** The drive appearances shown in the figures are for reference only, a real drive may look different.

Remove the cover for wiring. Frame A~D

Frame A & B

Screw torque: 12~15Kg-cm / [10.4~13lb-in.] / [1.2~1.5 Nm]

- 1) Remove the keypad. (As shown in figure 2)
- 2) Loosen the screws and press the tabs on both sides to remove the cover. (As shown in figure 3)

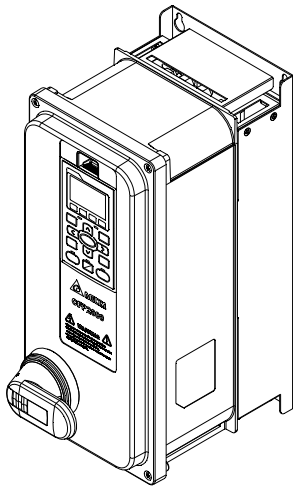

Figure 1

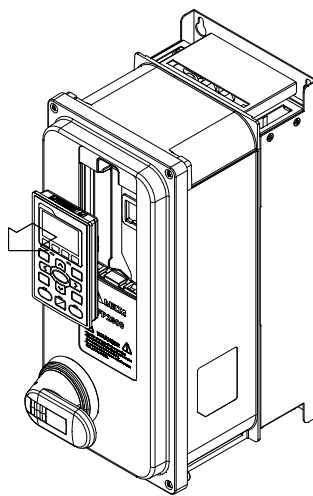

Figure 2

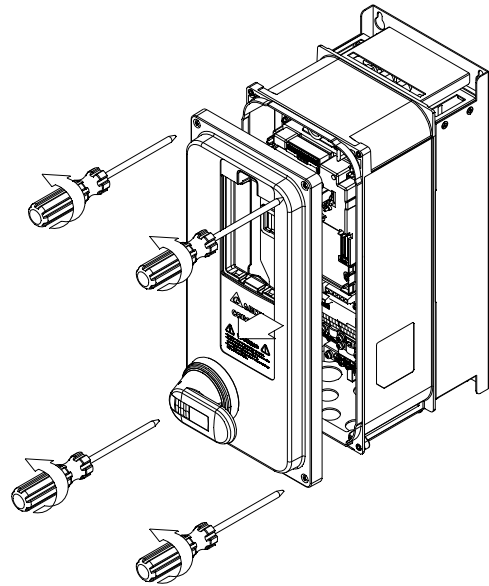

Figure 3

Frame C

Screw torque: 12~15Kg-cm / [10.4~13lb-in.] / [1.2~1.5 Nm]

- 1) Remove the keypad. (As shown in figure 2)
- 2) Loosen the screws and press the tabs on both sides to remove the cover. (As shown in figure 3)

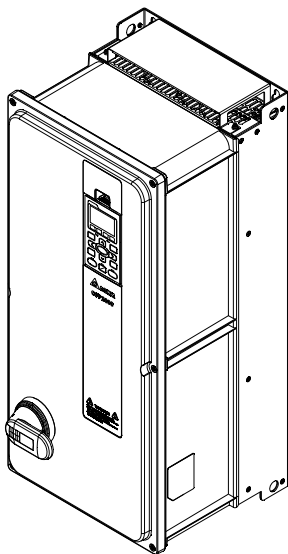

Figure 1

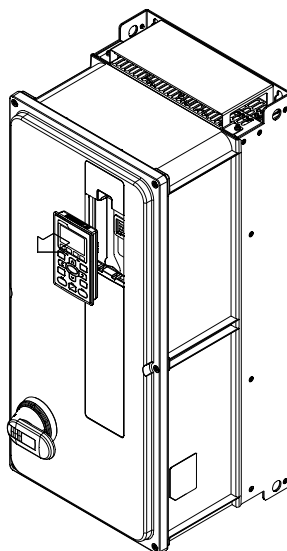

Figure 2

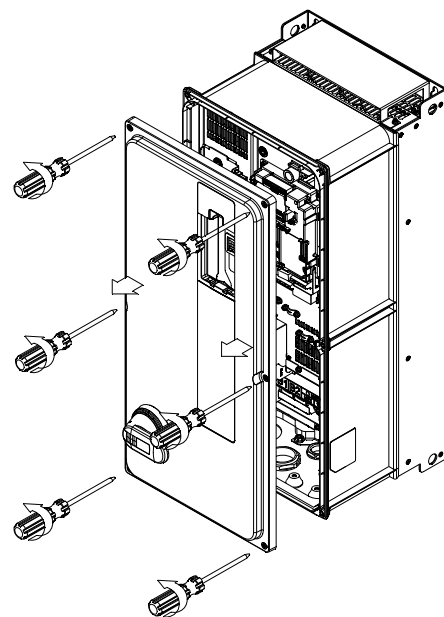

Figure 3

Frame D0

Screw torque: 14~16Kg-cm / [12.1~13.9lb-in.] / [1.4~1.6 Nm]

- 1) Remove the keypad. (As shown in figure 2)
- 2) Loosen the screws and press the tabs on both sides to remove the cover. (As shown in figure 3)

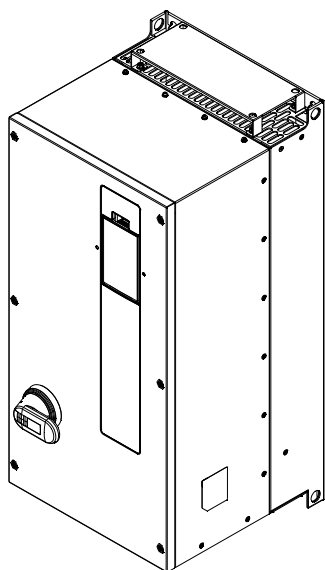

Figure 1

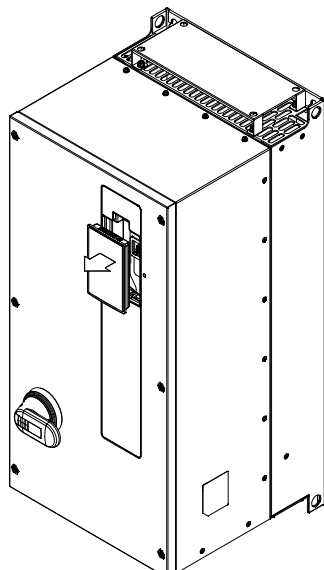

Figure 2

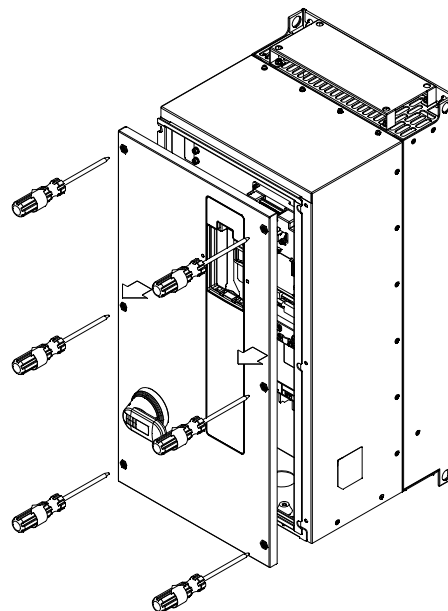

Figure 3

Frame D

Screw torque: 14~16Kgf-cm / [12.1~13.9lb-in.] / [1.4~1.6 Nm]

- 1) Remove the keypad. (As shown in figure 2)
- 2) Loosen the screw and press the tabs on both sides to remove the cover. (As shown in figure 3)

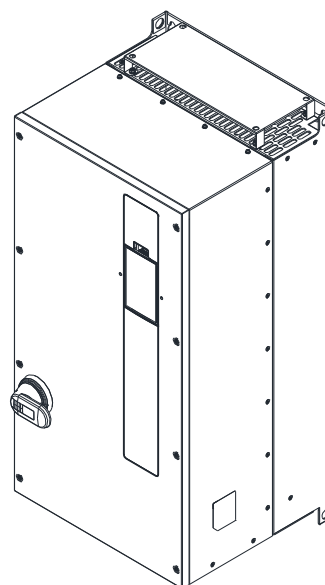

Figure 1

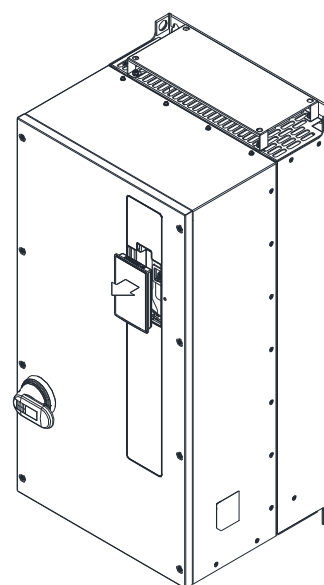

Figure 2

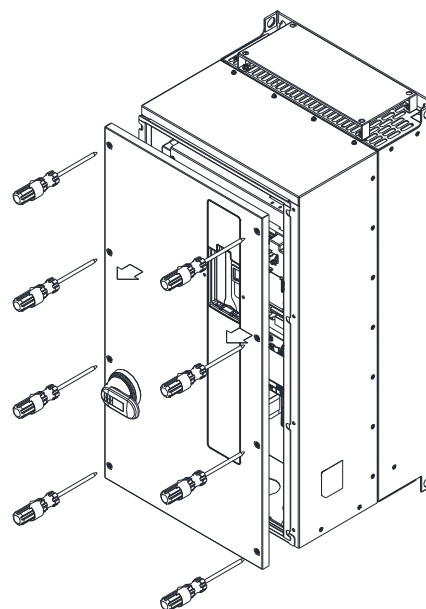
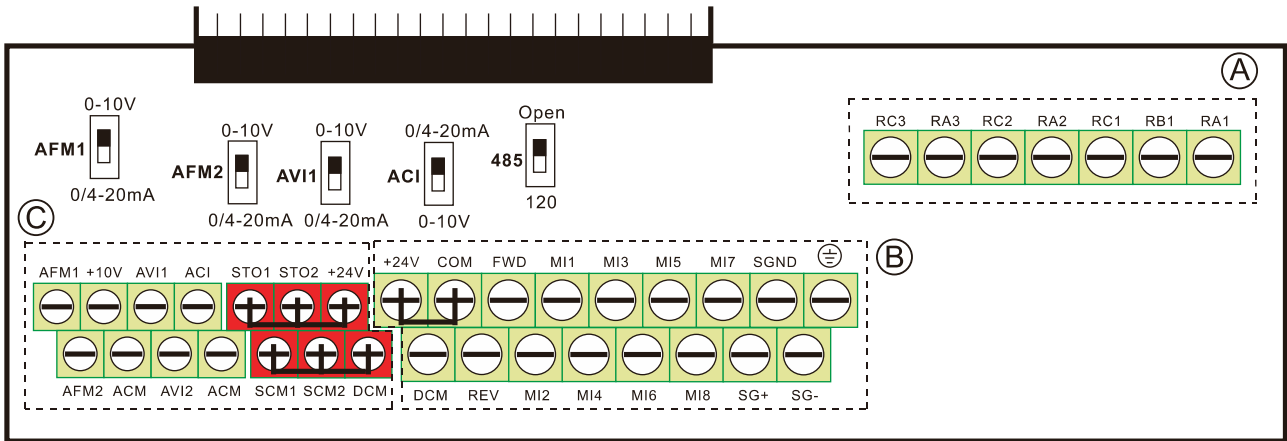

Figure 3

6-2 Specifications of Control Terminal



Removable Terminal Block

Wire Gauge: (A) (C) 0.2~1.5mm² / [24~16AWG]; (B) 0.2~1.5mm² / [26~16AWG]

Torque: (A) 5kg-cm / [4.3lb-in.] / [0.49 Nm] (As shown in figure above)

(B) 8kg-cm / [6.94 lb-in.] / [0.78 Nm] (As shown in figure above)

(C) 2kg-cm / [1.73 lb-in.] / [0.19 Nm] (As shown in figure above)

Wiring precautions:

- Reserves 5mm and properly install the wire into the terminal; fasten the installation by a slotted screwdriver. If the wire is stripped, sort the wire before install into the terminal.
- Tighten the wiring with slotted screwdriver:
 - (A) (B) is 3.5mm (wide) x 0.6mm (thick); (C) is 2.5mm (wide) x 0.4mm (thick)
- The ideal length of stripped wire at the connection side is 5mm.
- In the figure above, the factory setting for STO1, STO2, +24V and SCM1, SCM2, DCM are short circuit. The +24V is for STO only, and cannot be used for other purposes. The factory setting for +24V-COM is short circuit and SINK mode (NPN); please refer to Chapter 4 Wiring for more detail.

Terminals	Terminal Function	Factory Setting (NPN mode)
+24V	Digital control signal common (Source)	+24V±5% 200mA
COM	Digital control signal common (Sink)	Common for multi-function input terminals
FWD	Forward-Stop command	FWD-DCM: ON→ forward running OFF→ deceleration to stop
REV	Reverse-Stop command	REV-DCM: ON→ reverse running OFF→ deceleration to stop
MI1 ~ MI8	Multi-function input 1~8	Refer to parameters 02-01~02-08 to program the multi-function inputs MI1~MI8. Source mode ON: the activation current is 3.3mA ≥ 11VDC OFF: cut-off voltage ≤ 5VDC Sink Mode ON: the activation current is 3.3mA ≤ 13VDC OFF: cut-off voltage ≥ 19VDC
DCM	Digital frequency signal common	Regard the pulse as the output monitor signal Duty-cycle: 50% Min. load impedance: 1kΩ/100pf Max. current: 30mA Max. voltage: 30VDC

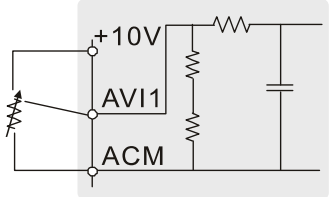
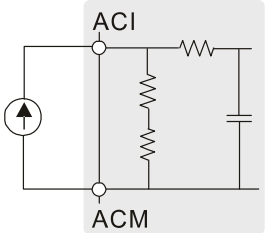
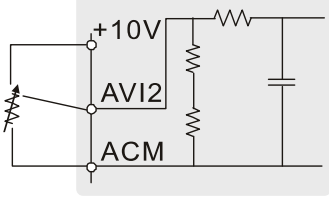
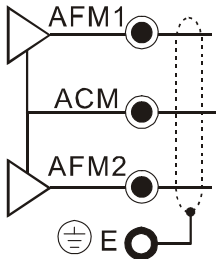
Terminals	Terminal Function	Factory Setting (NPN mode)
RA1	Multi-function relay output 1 (N.O.) a	It is used to output each monitor signal, such as drive is in operation, frequency attained or overload indication.
RB1	Multi-function relay output 1 (N.C.) b	Resistive Load: 250VAC / 3A (N.O.), 250VAC / 3A (N.C.) 30VDC / 5A (N.O.), 30VDC / 3A (N.C.)
RC1	Multi-function relay common	Inductive Load (COS 0.4): 250VAC / 1.2A (N.O.) 250VAC / 1.2A (N.C.)
RA2	Multi-function relay output 2 (N.O.) a	It is used to output each monitor signal, such as drive is in operation, frequency attained or overload indication.
RC2	Multi-function relay common	Resistive Load: 250VAC / 3A (N.O.) 30VDC / 5A (N.O.)
RA3	Multi-function relay output 2 (N.O.) a	Inductive Load (COS 0.4): 250VAC / 1.2A (N.O.)
RC3	Multi-function relay common	250VAC / 1.2A (N.O.)
+10V	Potentiometer power supply	Analog frequency setting: +10VDC 20mA
AVI1	Analog voltage input  Internal circuit	Impedance: 20kΩ Range: 0~20mA/4~20mA/0~10V = 0~Max. Output Frequency (Pr.01-00) AVI1 switch, factory setting is 0~10V
ACI	Analog current input  Internal circuit	Impedance: 250Ω Range: 0~20mA/4~20mA/0~10V = 0 ~ Max. Output Frequency (Pr.01-00) ACI Switch, factory setting is 4~20mA
AVI2	Auxiliary analog voltage input  Internal circuit	Impedance: 20kΩ Range: 0 ~ 10VDC=0~ Max. Output Frequency (Pr.01-00)
AFM1		0~10V Max. output current 2mA, Max. load 5kΩ 0~20mA Max. load 500Ω Output current: 20mA max Resolution: 0~10V corresponds to Max. operation frequency Range: 0~10V → 4~20mA AFM1/AFM2 Switch, factory setting is 0~10V
AFM2		
ACM	Analog Signal Common	Common for analog terminals
STO1	Default setting is shorted	
SCM1	Power removal safety function for EN954-1 and IEC/EN61508	

Terminals	Terminal Function	Factory Setting (NPN mode)
STO2	When STO1~SCM1;STO2~SCM2 is activated, the activation current is 3.3mA \geq 11VDC Note: Please refer to CH 18 Safe Torque Off Function.	
SCM2		
SG+	Modbus RS-485 Note: Please refer to CH12 DESCRIPTION OF PARAMETER SETTINGS group 09 Communication Parameters for more information.	
SG-		
SGND		
RJ-45	PIN 1,2,7,8 : Reserved PIN 4: SG-	PIN 3, 6: SGND PIN 5: SG+

NOTE: Wire size of analog control signals: 18 AWG [0.75 mm²] with shielded wire

6-3 Remove the Terminal Block

1. Loosen the screws by screwdriver. (As shown in figure below).

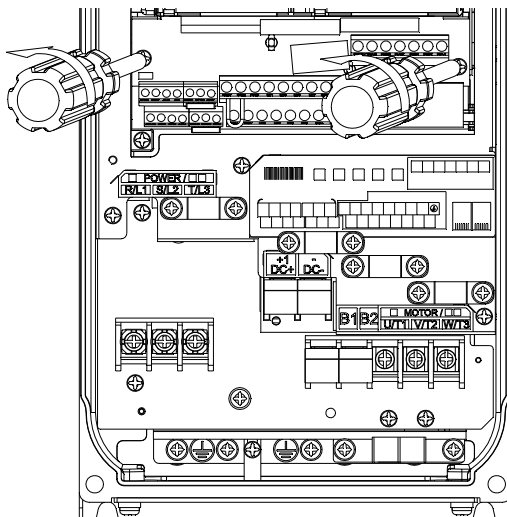

2. Remove the control board by pulling it out for a distance 6~8 cm (as 1 in the figure) then lift the control board upward (as 2 in the figure).

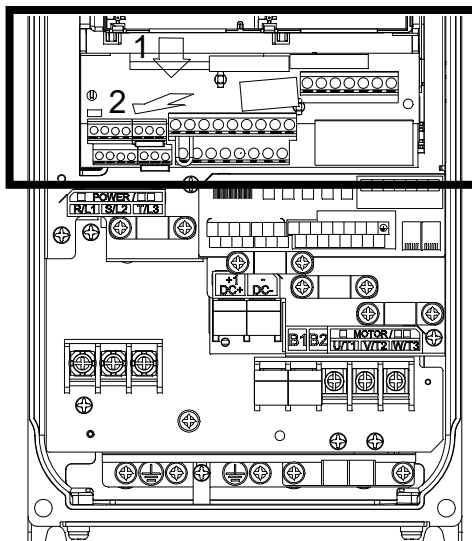

[This page intentionally left blank]

Chapter 7 Optional Accessories

7-1 Brake Resistors and Brake Units Selection Chart

7-2 Non-fuse Circuit Breaker

7-3 Fuse Specification Chart

7-4 AC Reactor

7-5 Zero Phase Reactor

7-6 EMC Filter

7-7 Panel Mounting

7-8 Fan Kit

7-9 USB/RS-485 Communication Interface IFD6530

The optional accessories listed in this chapter are available upon request. Installing additional accessories to your drive would substantially improve the drive’s performance. Please select an applicable accessory according to your need or contact the local distributor for suggestion.

7-1 Brake Resistors and Brake Units Selection Chart

Applicable Motor		125%Braking Torque 10%ED*1						Max. Brake Torque*2			
HP	kW	Braking Torque [kg-m]	Brake Unit	Braking Resistor series for each Brake Unit*4			Resistor value spec. for each AC motor Drive	Total Braking Current [A]	Min. Resistor Value [Ω]	Max. Total Braking Current [A]	Peak Power [kW]
			VFDB*3	P/N	Q'ty	Usage					
1	0.75	0.5	-	BR080W750	1	-	80W750Ω	1	190.0	4	3.0
2	1.5	0.5	-	BR080W750	1	-	80W750Ω	1	190.0	4	3.0
3	2.2	1.0	-	BR200W360	1	-	200W360Ω	2.1	126.7	6	4.6
5	3.7	1.5	-	BR300W250	1	-	300W250Ω	3	108.6	7	5.3
5	4.0	2.5	-	BR400W150	1	-	400W150Ω	5.1	84.4	9	6.8
7.5	5.5	2.7	-	BR1K0W075	1	-	1000W75Ω	10.2	54.3	14	10.6
10	7.5	3.7	-	BR1K0W075	1	-	1000W75Ω	10.2	54.3	14	10.6
15	11	5.1	-	BR1K0W075	1	-	1000W75Ω	10.2	47.5	16	12.2
20	15	7.4	-	BR1K5W043	1	-	1500W43Ω	17.6	42.2	18	13.7
25	18	10.2	-	BR1K0W016	2	2 series	2000W32Ω	24	26.2	29	22.0
30	22	12.2	-	BR1K0W016	2	2 series	2000W32Ω	24	23.0	33	25.1
40	30	14.9	-	BR1K5W013	2	2 series	3000W26Ω	29	23.0	33	25.1
50	37	20.3	-	BR1K0W016	4	2 parallel, 2 series	4000W16Ω	47.5	14.1	54	41.0
60	45	25	4045*1	BR1K2W015	4	2 parallel, 2 series	4800W15Ω	50	12.7	60	45.6
75	55	30.5	4045*1	BR1K5W013	4	2 parallel, 2 series	6000W13Ω	59	12.7	60	45.6
100	75	37.2	4030*2	BR1K0W5P1	4	4 series	8000W10.2Ω	76	9.5	80	60.8
125	90	50.8	4045*2	BR1K2W015	4	2 parallel, 2 series	9600W7.5Ω	100	6.3	120	91.2

- *1 Calculation for 125% brake torque: (kW)*125%*0.8; where 0.8 is motor efficiency. Because there is a resistor limit of power consumption, the longest operation time for 10%ED is 10sec (on: 10sec/ off: 90sec).
- *2 Please refer to the Brake Performance Curve for “Operation Duration & ED” vs. “Braking Current”.
- *3 The calculation of braking resistor is based on the 4 poles motor (1800rpm). Please refer to VFDB series Braking Module Instruction for more detail on braking resistor.
- *4 For heat dissipation, a resistor of 400W or lower should be fixed to the frame and maintain the surface temperature below 250°C; a resistor of 1000W and above should maintain the surface temperature below 600°C.

NOTE

1. Specifications and Appearances of Brake Resistors
 - 1-1 Wire Wound Resistors: For 1000W (included) and above, see Figure 7-1 for product appearances and Table 7-1 for model and specification comparison.

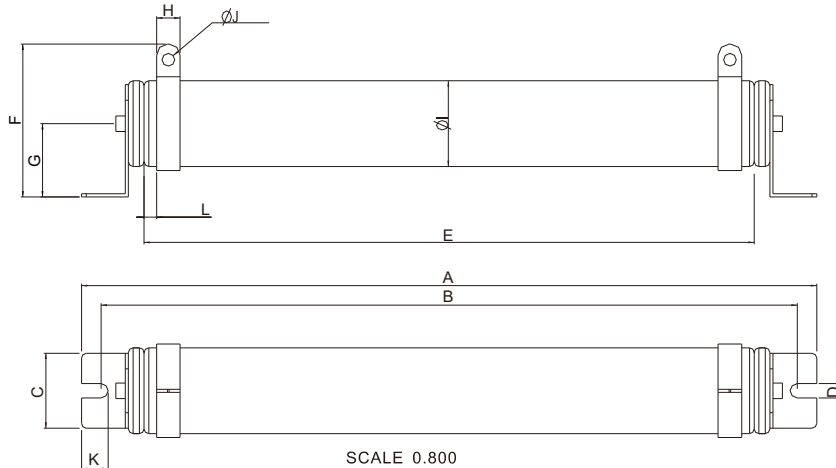

Figure 7-1

Models and Specifications Comparison Table of Wire Wound Resistors:

UNIT: MM

MODEL	A	B	C	D	E	F	G	H	ØI	ØJ	K	L
BR1K0W4P3	470±10	445±5	48±0.2	9.1±0.1	390±3	98±5	47±5	15±1	55±5	8.1±0.1	21±0.2	8±1
BR1K0W5P1												
BR1K0W016												
BR1K0W020												
BR1K0W075												
BR1K2W3P9												
BR1K2W015												
BR1K5W3P3												
BR1K5W012												
BR1K5W013												
BR1K5W043												

Table 7-1

1-2 Aluminum Housed Resistors: For less than 1000W.

For more information, see Figure 7- 2 for product appearances and Table 7-2 for model and specification comparison.

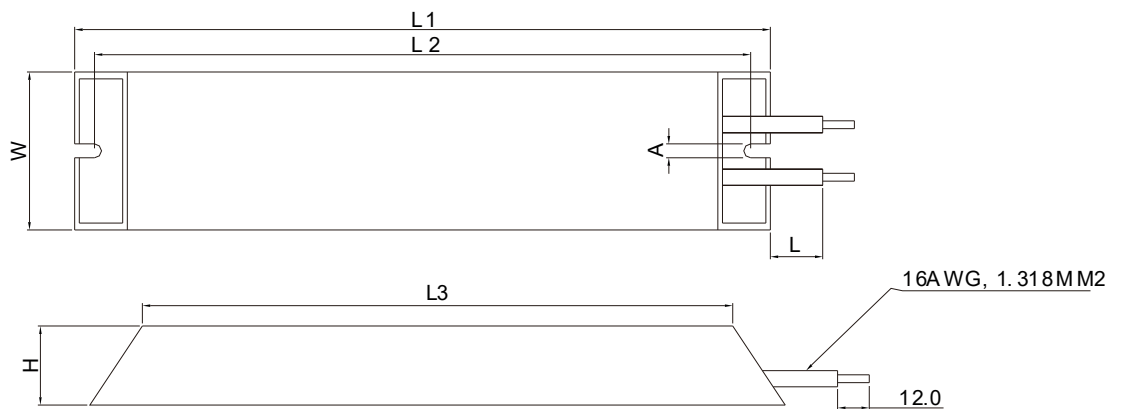

Figure 7-2

MODEL	L1	L2	L3	W	H	A	L
BR080W200	140±2	125±2	100±1	40±0.5	20±0.5	5.3±0.5	200±20
BR080W750							
BR200W091	165±2	150±2	125±1	60±0.5	30±0.5		
BR200W360							
BR300W070	215±2	200±2	175±1				
BR300W250							
BR400W040	265±2	250±2	225±1				
BR400W150							

Unit: mm

Table 7-2

2. How to install brake resistors?

2-1 Clearance around brake resistors (See Fig. 7-3~7-8)

- The side clearance around the brake resistor should be over 150mm.
- The top clearance between the brake resistor should be over 500mm.
- The clearance between two brake resistors should be at least 150mm.

Single brake resistor

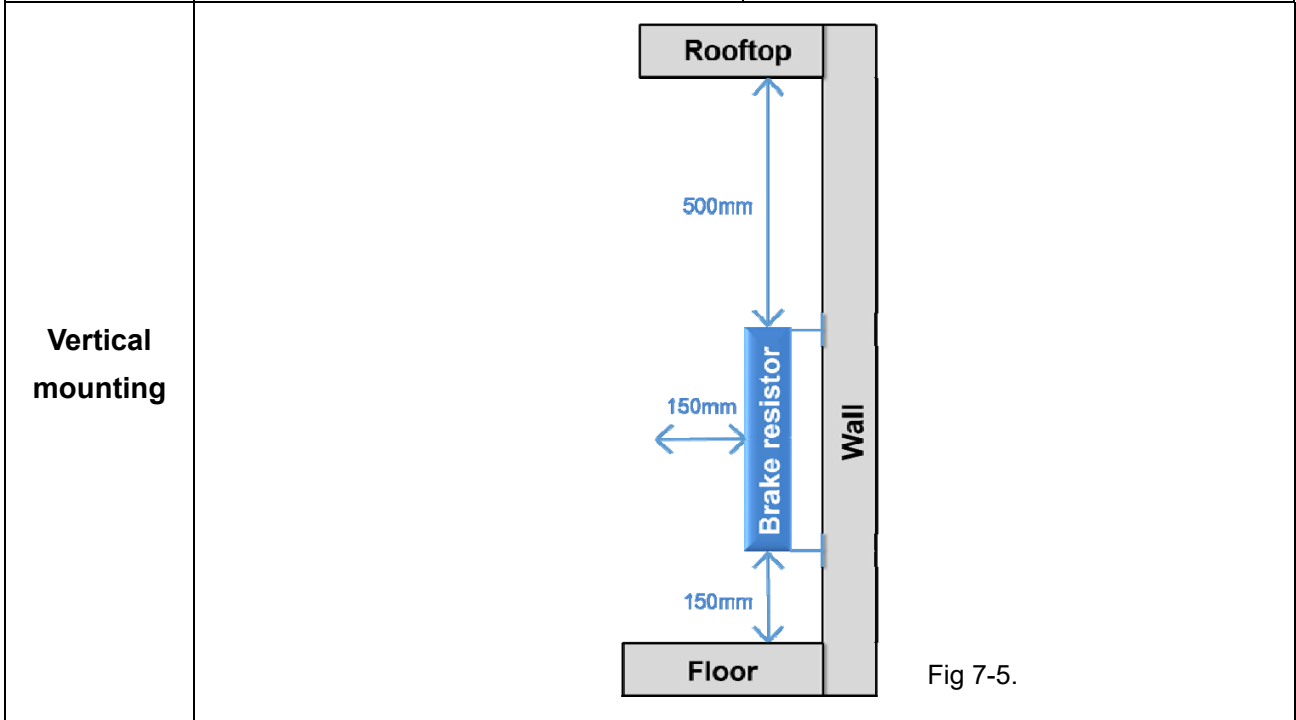
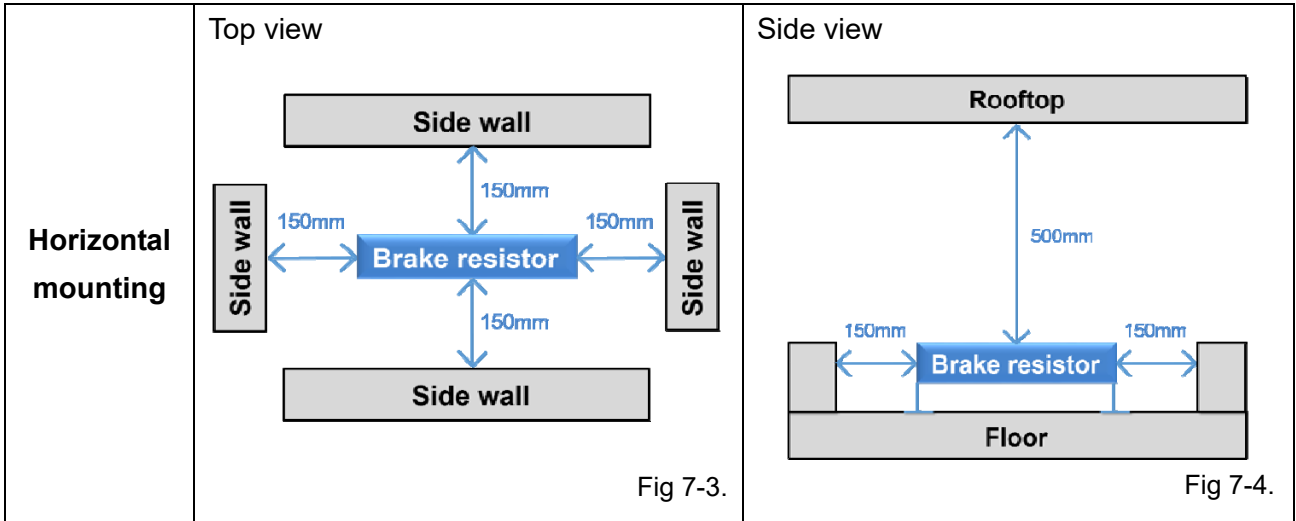

Multiple brake resistor

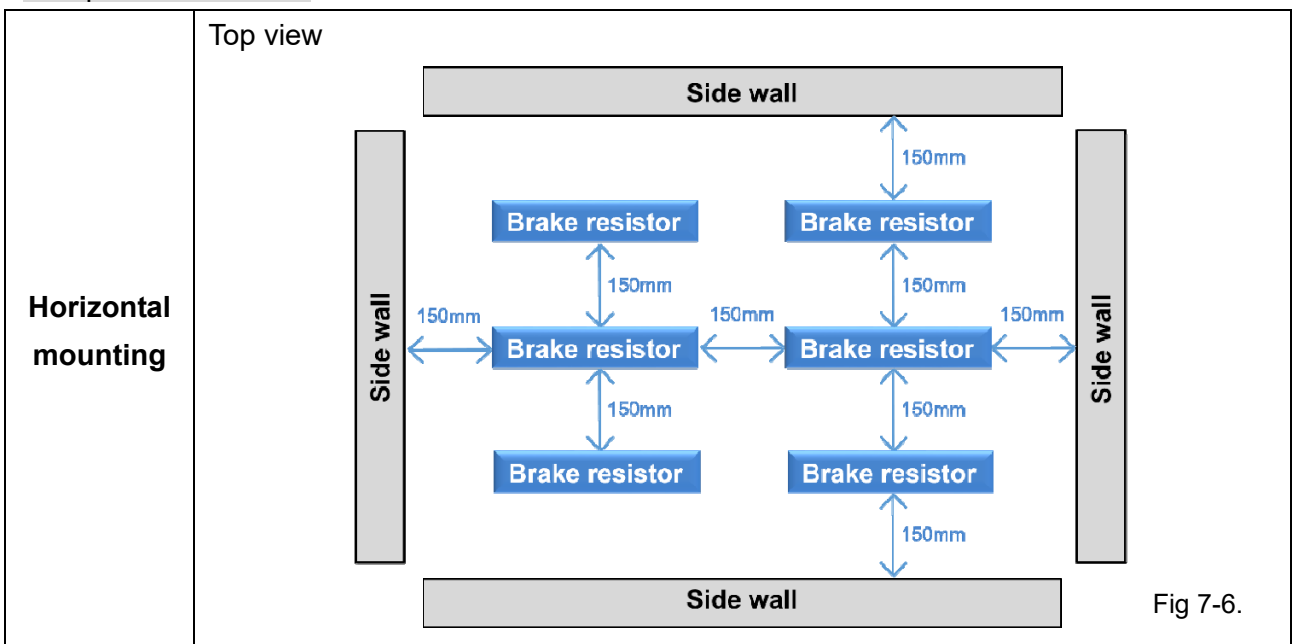

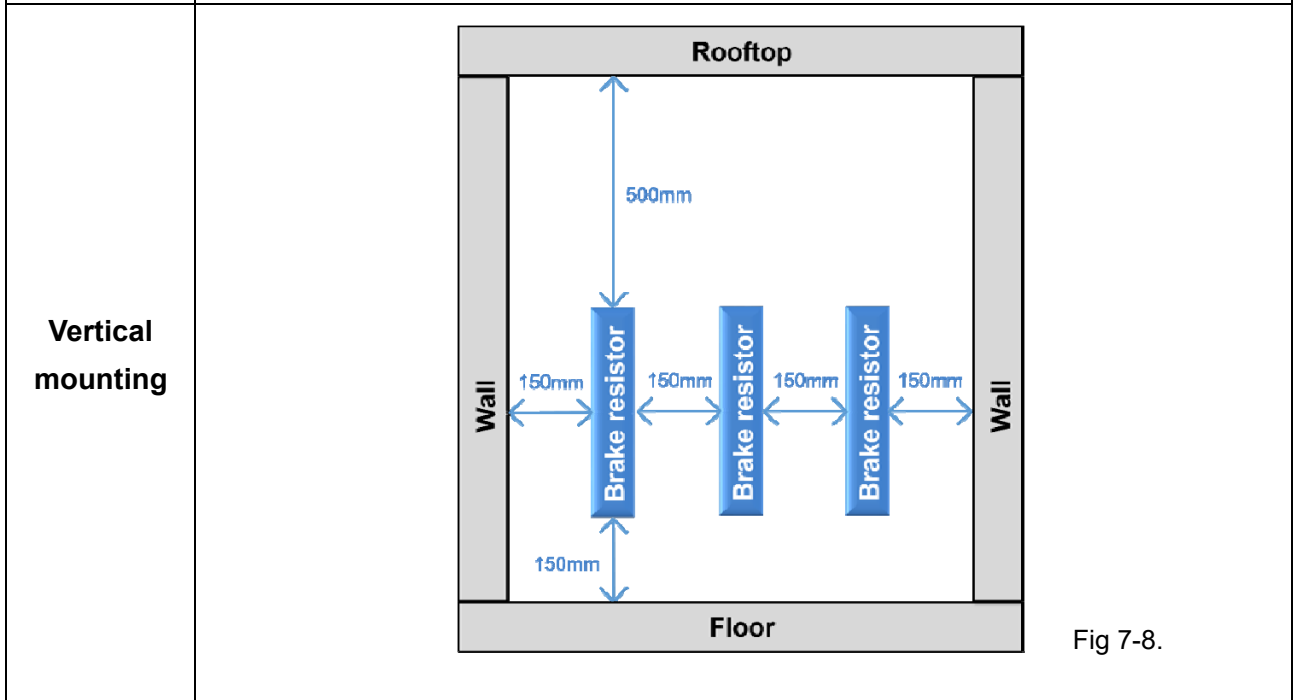
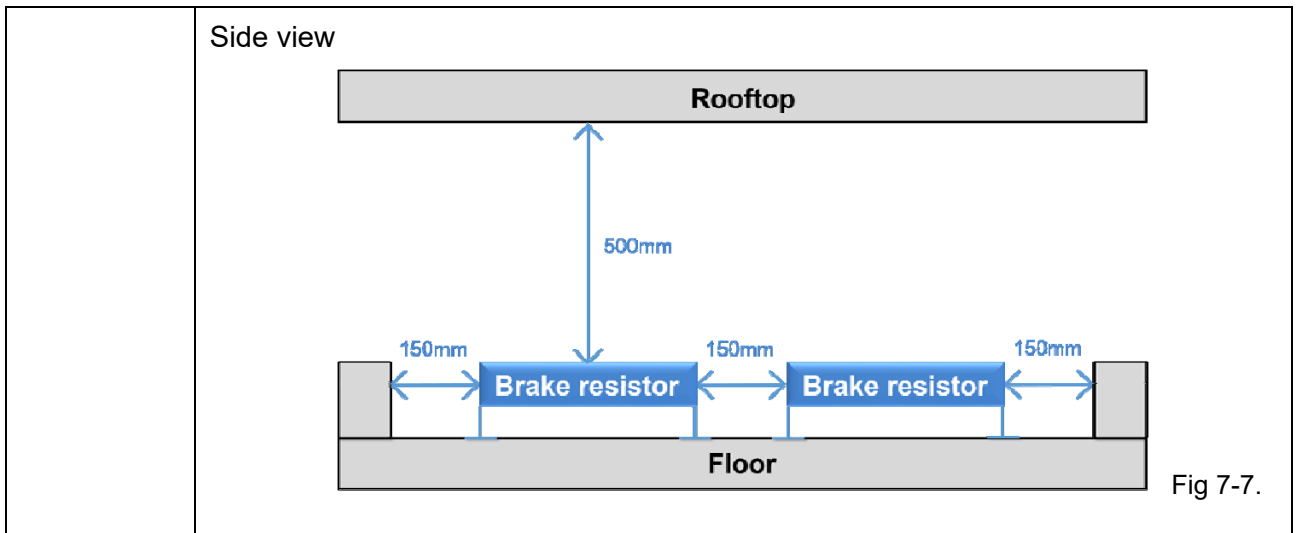

2-2 Installation limits

Both horizontal and vertical mounting is safe, if there is sufficient clearance and the brake resistor is installed on the right position. Take notice on the following:

- Do not install brake resistors on another brake resistor or above any emission of hot air. (See Fig. 7-9)
- Under the condition of vertical mounting, the connection of cable should not be on the top of the brake resistor. (See Fig. 7-10)

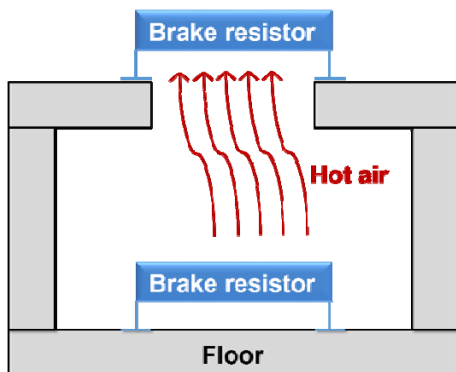

Fig 7-9.

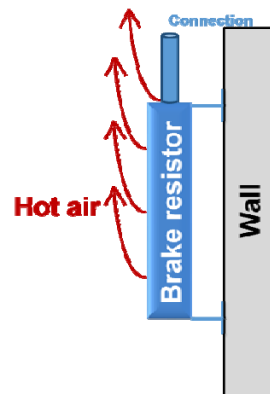
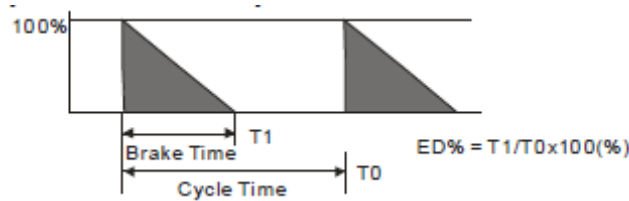

Fig 7-10.

3. Definition for Brake Usage ED%

Explanation: The definition of the brake usage ED (%) is for assurance of enough time for the brake unit and brake resistor to dissipate away heat generated by braking. When the brake resistor heats up, the resistance would increase with temperature, and brake torque would decrease accordingly. Recommended cycle time is one minute.



For safety concern, install an overload relay (O.L) between the brake unit and the brake resistor in conjunction with the magnetic contactor (MC) prior to the drive for abnormal protection. The purpose of installing the thermal overload relay is to protect the brake resistor from damage due to frequent brake, or due to brake unit keeping operating resulted from unusual high input voltage. Under such circumstance, just turn off the power to prevent damaging the brake resistor.

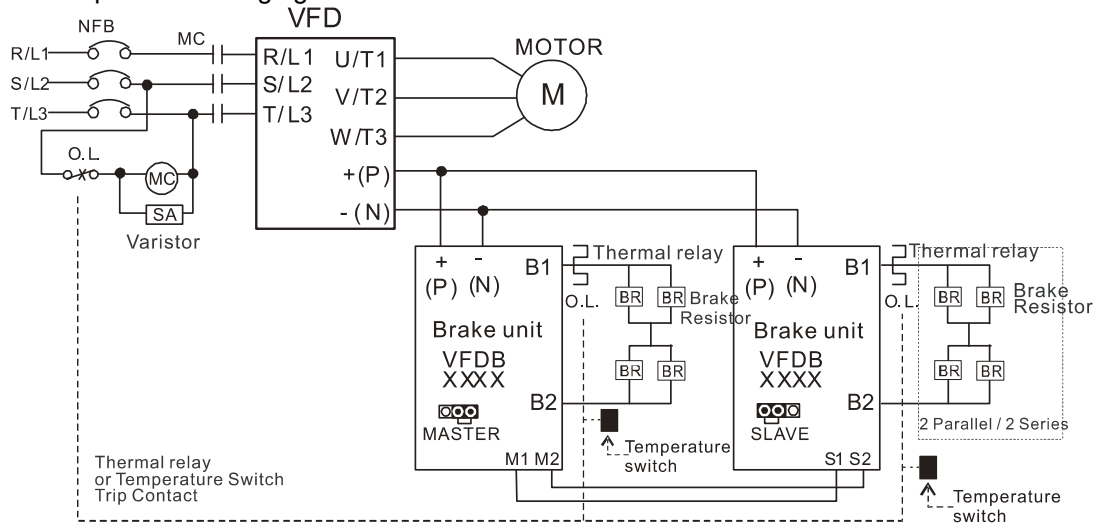

- When AC Drive is equipped with a DC reactor, please read user manual to know the wiring method of input circuit of brake unit +(P).
- DO NOT connect input circuit -(N) to the neutral point of the power system.

4. If damage to the drive or other equipment is due to the fact that the brake resistors and brake modules in use are not provided by Delta, the warranty will be void.
5. Take into consideration the safety of the environment when installing the brake resistors. If the minimum resistance value is to be utilized, consult local dealers for the calculation of Watt figures.
6. When using more than 2 brake units, equivalent resistor value of parallel brake unit can't be less than the value in the column "Minimum Equivalent Resistor Value for Each AC Drive" (the right-most column in the table). Please read the wiring information in the user manual of brake unit thoroughly prior to operation
7. This chart is for normal usage; if the AC motor drive is applied for frequent braking, it is suggested to enlarge 2~3 times of the Watts.
8. Thermal Relay:

Thermal relay selection is basing on its overload capability. A standard braking capacity for CFP2000 is 10%ED (Tripping time=10s). The figure below is an example of 460V, 110kw AC motor drive. It requires the thermal relay to take 260% overload capacity in 10s (Host starting) and the braking current is 126A. In this case, user should select a rated 50A thermal relay. The property of each thermal relay may vary among different manufacturer, please carefully read specification.

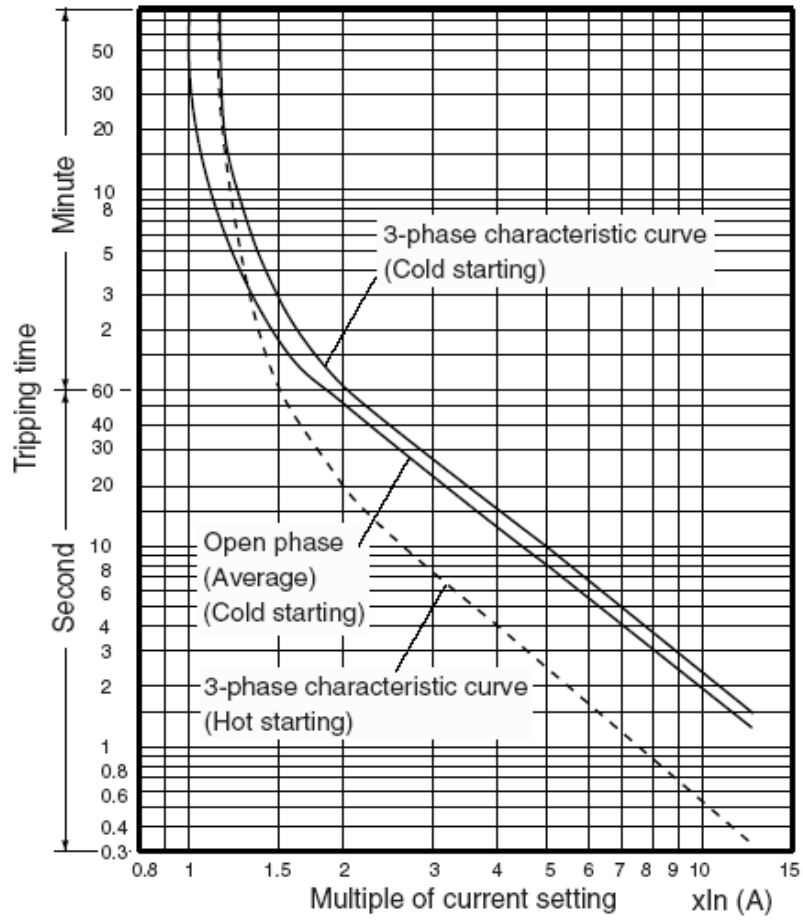

7-2 Non-fuse Circuit Breaker

Comply with UL standard: Per UL 508, paragraph 45.8.4, part a.

The rated current of the breaker shall be 1.6~2.6 times of the maximum rated input current of AC motor drive.

Model	Recommended non-fuse breaker (A)
VFD007FP4EA-41/ VFD007FP4EA-52/ VFD007FP4EA-52S	6
VFD015FP4EA-41/ VFD015FP4EA-52/ VFD015FP4EA-52S	6
VFD022FP4EA-41/ VFD022FP4EA-52/ VFD022FP4EA-52S	10
VFD037FP4EA-41/ VFD037FP4EA-52/ VFD037FP4EA-52S	15
VFD040FP4EA-41/ VFD040FP4EA-52/ VFD040FP4EA-52S	15
VFD055FP4EA-41/ VFD055FP4EA-52/ VFD055FP4EA-52S	20
VFD075FP4EA-41/ VFD075FP4EA-52/ VFD075FP4EA-52S	25
VFD110FP4EA-41/ VFD110FP4EA-52/ VFD110FP4EA-52S	35
VFD150FP4EA-41/ VFD150FP4EA-52/ VFD150FP4EA-52S	50
VFD185FP4EA-41/ VFD185FP4EA-52/ VFD185FP4EA-52S	60
VFD220FP4EA-41/ VFD220FP4EA-52/ VFD220FP4EA-52S	60
VFD300FP4EA-41/ VFD300FP4EA-52/ VFD300FP4EA-52S	90
VFD370FP4EA-41/ VFD370FP4EA-52/ VFD370FP4EA-52S	100
VFD450FP4EA-41/ VFD450FP4EA-52/ VFD450FP4EA-52S	125
VFD550FP4EA-41/ VFD550FP4EA-52/ VFD550FP4EA-52S	150
VFD750FP4EA-41/ VFD750FP4EA-52/ VFD750FP4EA-52S	200
VFD900FP4EA-41/ VFD900FP4EA-52/ VFD900FP4EA-52S	250

7-3 Fuse Specification Chart

Fuses with specification smaller than the following table indicates are allowed.

- ☑ “For installation in the United States, branch circuit protection must be provided in accordance with the National Electrical Code (NEC) and any applicable local codes. To fulfill this requirement, use the UL classified fuses.”
- ☑ “For installation in Canada, branch circuit protection must be provided in accordance with Canadian Electrical Code and any applicable provincial codes. To fulfill this requirement, use the UL classified fuses.”
- ☑ Short-circuit current rating (SCCR): Per UL508C, the drive is suitable for use on a circuit capable of delivering not more than 100kA symmetrical amperes (rms) when protected by fuses given in the fuse table.

Model	Input Current I [A]		Line Fuse	
	Light Duty	Normal Duty	I [A]	Bussmann P/N
VFD007FP4EA-41/ VFD007FP4EA-52/ VFD007FP4EA-52S	3.0	1.7	6	JJS-6
VFD015FP4EA-41/ VFD015FP4EA-52/ VFD015FP4EA-52S	4.2	3	6	JJS-6
VFD022FP4EA-41/ VFD022FP4EA-52/ VFD022FP4EA-52S	5.5	4	10	JJS-10
VFD037FP4EA-41/ VFD037FP4EA-52/ VFD037FP4EA-52S	8.5	6	15	JJS-15
VFD040FP4EA-41/ VFD040FP4EA-52/ VFD040FP4EA-52S	10.5	9	15	JJS-15
VFD055FP4EA-41/ VFD055FP4EA-52/ VFD055FP4EA-52S	13	10.5	20	JJS-20
VFD075FP4EA-41/ VFD075FP4EA-52/ VFD075FP4EA-52S	18	12	25	JJS-25
VFD110FP4EA-41/ VFD110FP4EA-52/ VFD110FP4EA-52S	24	18	35	JJS-35
VFD150FP4EA-41/ VFD150FP4EA-52/ VFD150FP4EA-52S	32	24	50	JJS-50
VFD185FP4EA-41/ VFD185FP4EA-52/ VFD185FP4EA-52S	38	32	60	JJS-60
VFD220FP4EA-41/ VFD220FP4EA-52/ VFD220FP4EA-52S	45	38	60	JJS-60
VFD300FP4EA-41/ VFD300FP4EA-52/ VFD300FP4EA-52S	60	45	90	JJS-90
VFD370FP4EA-41/ VFD370FP4EA-52/ VFD370FP4EA-52S	73	60	100	JJS-100
VFD450FP4EA-41/ VFD450FP4EA-52/ VFD450FP4EA-52S	91	73	125	JJS-125
VFD550FP4EA-41/ VFD550FP4EA-52/ VFD550FP4EA-52S	110	91	150	JJS-150
VFD750FP4EA-41/ VFD750FP4EA-52/ VFD750FP4EA-52S	150	110	200	JJS-200
VFD900FP4EA-41/ VFD900FP4EA-52/ VFD900FP4EA-52S	180	150	250	JJS-250

7-4 AC Reactor

AC Input Reactor

Installing AC reactor in the input side of AC motor drive can increase line impedance, improve power factor, reduce input current, increase system capacity and reduce interference generated from motor drive. In addition, to suppress the momentary voltage surge or abnormal current spike is also one of its features. For example, when the capacity of main power is higher than 500 kVA, or switching to capacity bank, the momentary voltage and current spike may damage motor drive's internal circuit. Therefore, installing AC reactor in the input side of AC motor drive can suppress the surge to protect the AC motor drive.

Installation

An AC input reactor is installed in series with the mains power to the three input phases R, S & T as shown below:

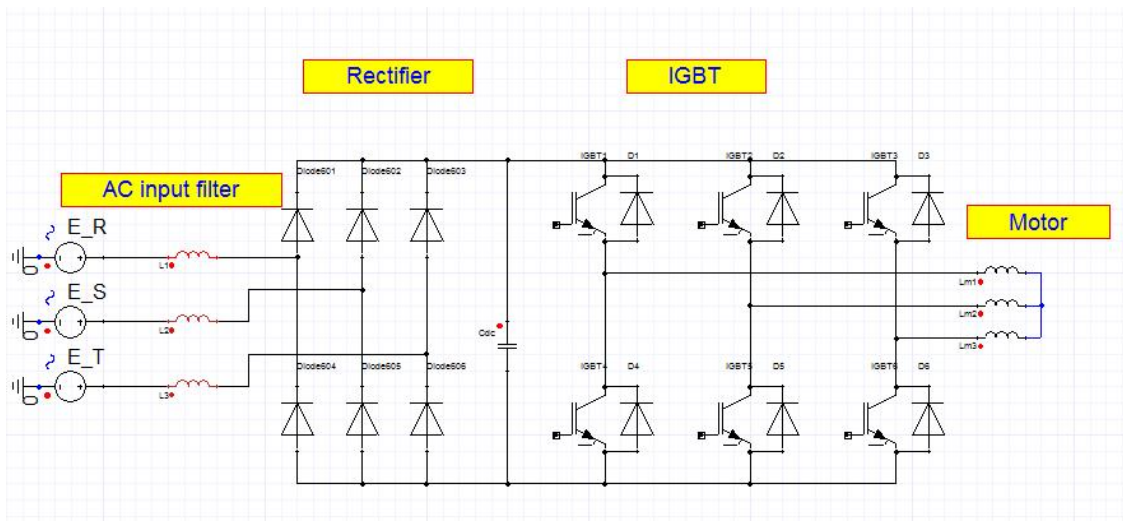

Wiring an AC input reactor

AC Input Reactor

Below table shows the specifications of AC input reactors (standard items).

380V~460V/ 50~60Hz

Type	KW	HP	Rated Amps of AC Reactor(Arms)		Max. continuous Amps (Arms)		3% impedance(mH)		5% impedance(mH)		Built-in DC reactor	3% Input AC reactor Delta part #	
			Normal Duty	Light Duty	Normal Duty	Light Duty	Normal Duty	Light Duty	Normal Duty	Light Duty		Normal Duty	Light Duty
007	0.75	1	1.7	3	2.72	3.6	14.918	8.102	24.863	13.503	Yes	DR003A0810*	DR003A0810
015	1.5	2	3	4.2	4.8	5.04	8.102	6.077	13.503	10.128	Yes	DR003A0810	DR004A0607
022	2.2	3	4	5.5	6.4	6.6	6.077	4.05	10.128	6.75	Yes	DR004A0607	DR006A0405
037	3.7	5	6	8.5	9.6	10.2	4.05	2.7	6.75	4.5	Yes	DR006A0405	DR009A0270
040	4	5	9	10.5	14.4	12.6	2.7	2.315	4.5	3.858	Yes	DR009A0270	DR010A0231
055	5.5	7.5	10.5	13	16.8	15.6	2.315	2.025	3.858	3.375	Yes	DR010A0231	DR012A0202
075	7.5	10	12	18	19.2	21.6	2.025	1.35	3.375	2.25	Yes	DR012A0202	DR018A0117
110	11	15	18	24	28.8	28.8	1.35	1.01	2.25	1.683	Yes	DR018A0117	DR024AP881
150	15	20	24	32	38.4	38.4	1.01	0.76	1.683	1.267	Yes	DR024AP881	DR032AP660

Type	KW	HP	Rated Amps of AC Reactor(Arms)		Max. continuous Amps (Arms)		3% impedance(mH)		5% impedance(mH)		Built-in DC reactor	3% Input AC reactor Delta part #	
			Normal Duty	Light Duty	Normal Duty	Light Duty	Normal Duty	Light Duty	Normal Duty	Light Duty		Normal Duty	Light Duty
185	18.5	25	32	38	51.2	45.6	0.76	0.639	1.267	1.065	Yes	DR032AP660	DR038AP639
220	22	30	38	45	60.8	54	0.639	0.541	1.065	0.902	Yes	DR038AP639	DR045AP541
300	30	40	45	60	72	72	0.541	0.405	0.902	0.675	Yes	DR045AP541	DR060AP405
370	37	50	60	73	96	87.6	0.405	0.334	0.675	0.557	Yes	DR060AP405	DR073AP334
450	45	60	73	91	116.8	109.2	0.334	0.267	0.557	0.445	Yes	DR073AP334	DR091AP267
550	55	75	91	110	145.6	132	0.267	0.221	0.445	0.368	Yes	DR091AP267	DR110AP221
750	75	100	110	150	176	180	0.221	0.162	0.368	0.27	Yes	DR110AP221	DR150AP162
900	90	125	150	180	240	216	0.162	0.135	0.27	0.225	Yes	DR150AP162	DR180AP135

NOTE * : Use with DR003A0810, but the inductance value will be 3% short.

The following table is spec. of THDi that Delta AC motor drives use with AC reactors.

Motor Drive Spec	With Built in DC Reactor		
Reactor Spec.	Without installation AC/DC Reactor	3% Input AC Reactor	5% Input AC Reactor
5th	31.16%	27.01%	25.5%
7th	23.18%	9.54%	8.75%
11th	8.6%	4.5%	4.2%
13th	7.9%	0.22%	0.17%
THDi	42.28%	30.5%	28.4%
Note:	THDi may have some difference due to different installation conditions and environment.		

THDi Spec.

AC Output Reactor

If the length of cable between AC motor drive and motor is too long, it may make AC motor drive trigger protection mechanism for GF (Ground Fault), OC (Over Current) and the AC motor drive stops running. The cause is the over long motor cable will generate extremely large stray capacitance, make common mode current of 3-phase output get too large and then trigger GF protection mechanism; OC protection is triggered which is caused by stray capacitance of cable-cable and cable-ground are getting larger, and its surge current makes AC motor drive output over large current. To prevent from the common mode current that stray capacitance generates, set up AC output reactor between AC motor drive and motor to increase the high frequency impedance.

Power transistor is switched via PWM to control the output voltage and frequency for AC motor drive. During the switch process, impulse voltage (dv/dt) rises and falls rapidly will make inner voltage of motor distribute unequally, and then the isolation of motor will be getting worse, and have interference of bearing current and electromagnet. Especially when AC motor drive and motor are connected by long leading wire, the influence of damping of high frequency resonance and reflected voltage that caused by cable spreading parameters is getting large, and it will generate twice incoming voltage at motor side to be over voltage, destroy the isolation.

Installation

An AC input reactor is installed in series with the mains power to the three input phases R S T as shown below:

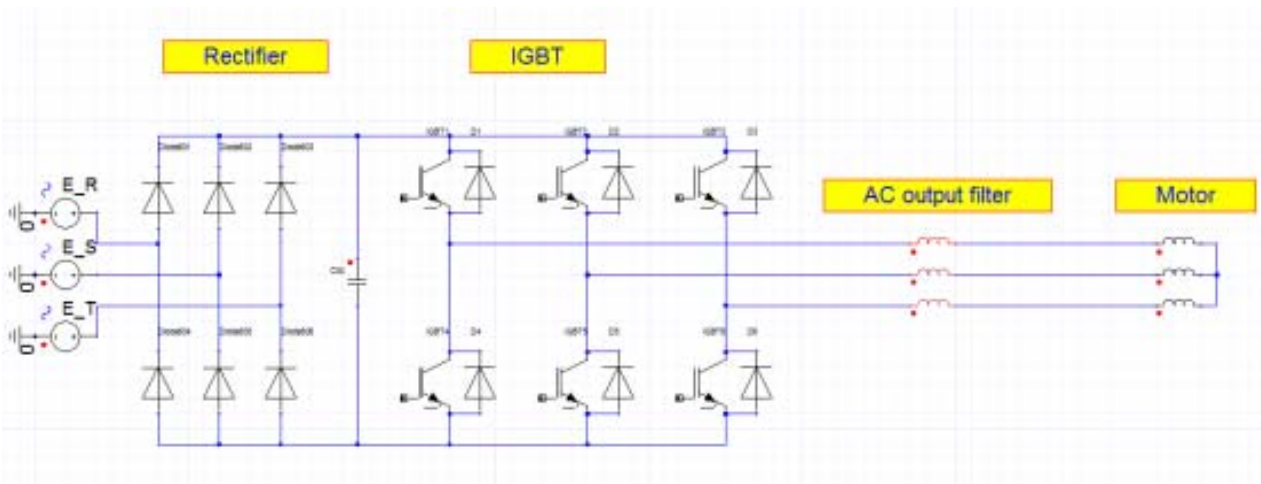

Wiring an AC output reactor

AC Output Reactor

Below table shows the specifications of AC output reactors (standard items).
380V~460V/ 50~60Hz

Type	KW	HP	Rated Amps of AC Reactor(Arms)		Max. continuous Amps (Arms)		3% impedance(mH)		5% impedance(mH)		Built-in DC reactor	3% Input AC reactor Delta part #	
			Normal Duty	Light Duty	Normal Duty	Light Duty	Normal Duty	Light Duty	Normal Duty	Light Duty		Normal Duty	Light Duty
007	0.75	1	1.7	3	2.72	3.6	14.918	8.102	24.863	13.503	Yes	DR003A0810*	DR003A0810
015	1.5	2	3	4.2	4.8	5.04	8.102	6.077	13.503	10.128	Yes	DR003A0810	DR004A0607
022	2.2	3	4	5.5	6.4	6.6	6.077	4.050	10.128	6.75	Yes	DR004A0607	DR006A0405

Type	KW	HP	Rated Amps of AC Reactor(Arms)		Max. continuous Amps (Arms)		3% impedance(mH)		5% impedance(mH)		Built-in DC reactor	3% Input AC reactor Delta part #	
			Normal Duty	Light Duty	Normal Duty	Light Duty	Normal Duty	Light Duty	Normal Duty	Light Duty		Normal Duty	Light Duty
037	3.7	5	6	8.5	9.6	10.2	4.050	2.700	6.75	4.5	Yes	DR006A0405	DR009A0270
040	4	5	9	10.5	14.4	12.6	2.700	2.315	4.5	3.858	Yes	DR009A0270	DR010A0231
055	5.5	7.5	10.5	13	16.8	15.6	2.315	2.025	3.858	3.375	Yes	DR010A0231	DR012A0202
075	7.5	10	12	18	19.2	21.6	2.025	1.35	3.375	2.25	Yes	DR012A0202	DR018A0117
110	11	15	18	24	28.8	28.8	1.35	1.01	2.25	1.683	Yes	DR018A0117	DR024AP881
150	15	20	24	32	38.4	38.4	1.01	0.76	1.683	1.267	Yes	DR024AP881	DR032AP660
185	18.5	25	32	38	51.2	45.6	0.76	0.639	1.267	1.065	Yes	DR032AP660	DR038AP639
220	22	30	38	45	60.8	54	0.639	0.541	1.065	0.902	Yes	DR038AP639	DR045AP541
300	30	40	45	60	72	72	0.541	0.405	0.902	0.675	Yes	DR045AP541	DR060AP405
370	37	50	60	73	96	87.6	0.405	0.334	0.675	0.557	Yes	DR060AP405	DR073AP334
450	45	60	73	91	116.8	109.2	0.334	0.267	0.557	0.445	Yes	DR073AP334	DR091AP267
550	55	75	91	110	145.6	132	0.267	0.221	0.445	0.368	Yes	DR091AP267	DR110AP221
750	75	100	110	150	176	180	0.221	0.162	0.368	0.27	Yes	DR110AP221	DR150AP162
900	90	125	150	180	240	216	0.162	0.135	0.27	0.225	Yes	DR150AP162	DR180AP135

 **NOTE** * : Use with DR003A0810, but the inductance value will be 3% short.

Motor Cable Length

1. Leakage current to affect the motor and counter measurement

If the length is too long, the stray capacitance between cables will increase and may cause leakage current. It will activate the protection of over current, increase leakage current or not insure the correction of current display. The worst case is that AC motor drive may damage. If more than one motor is connected to the AC motor drive, the total wiring length is the sum of the wiring length from AC motor drive to each motor.

For 460V series AC motor drives, when an overload relay is installed between the drive and the motor to protect motor from overheating, the connecting cable must be shorter than 50m.

However, the overload relay could still malfunction. To prevent this, install an AC output reactor (optional) to the drive and/or lower the carrier frequency setting (Pr. 00-17).

2. Surge voltage to affect the motor and counter measurement

When motor is driven by an AC motor drive with PWM control, the motor terminals will experience surge voltages easily due to power transistors operation of AC motor drive and cable capacitance.

When the motor cable is very long (especially for the 460V series), surge voltages may reduce insulation quality. To prevent this situation, please follow the rules below:

- a. Use a motor with enhanced insulation (Please refer to following charts)
- b. Connect an output reactor (optional) to the output terminals of the AC motor drive
- c. The length of the cable between AC motor drive and motor should be as short as possible (10 to 20 m or less)

The suggested motor shielded cable length in the following table complies with IEC 60034-17, which is suitable for motors with a rated voltage ≤ 500 VAC and with an insulation level of peak-to-peak ≥ 1.35 kVp-p

Type	kW	HP	Rated Amps of AC Reactor (Arms)		Without AC Output Reactor		3% With AC Output Reactor	
			Normal Duty	Light Duty	Shielded cable [meter]	Non-shielded cable [meter]	Shielded cable [meter]	Non-shielded cable [meter]
007	0.75	1	1.7	3	50	75	75	115
015	1.5	2	3	4.2				
022	2.2	3	4	5.5				
037	3.7	5	6	8.5				
040	4	5	9	10.5				
055	5.5	7.5	10.5	13				
075	7.5	10	12	18	100	150	150	225
110	11	15	18	24				
150	15	20	24	32				
185	18.5	25	32	38				
220	22	30	38	45				
300	30	40	45	60				
370	37	50	60	73				
450	45	60	73	91	150	225	225	325
550	55	75	91	110				
750	75	100	110	150				
900	90	125	150	180				

7-5 Zero Phase Reactors

Interferences can be suppressed by installing a zero phase reactor. When encounter any interference, buy and install a zero phase reactor.

Zero Phase Reactors for Signal Cable

To solve interference problems between signal cables and electric devices, install a zero phase reactor on signal cable. Install it on the signal cable, which is the source of the interference to suppress the noise for a better signal. The model names and dimensions are in the table below.

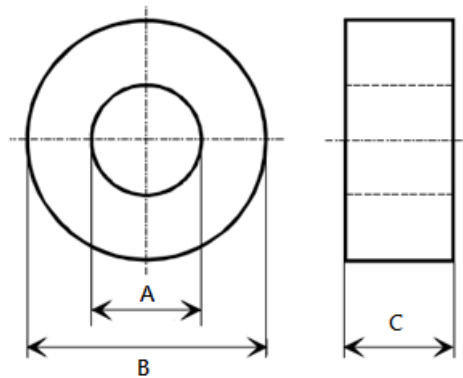

Unit: mm

Model	A	B	C
T60004L2016W620	10.7	17.8	8.0
T60004L2025W622	17.5	27.3	12.3

7-6 EMC Filter

Following table is the external EMC filter. Please install the EMC filter in accord to below notices, so as to have the best configuration to suppress the electromagnetic interference.

CFP2000 Model	Input Current	Zero phase reactor*1	CE Cable Length				Radiation Emission
			EN61800-3*5				
			Category C2	Carrier frequency (Hz)	Category C1*2	Carrier frequency (Hz)	C2*4
VFD007FP4EA-XXX	3.0A	RF010FP00A	75m	≤ 8K	25m	≤ 4K*3	Pass
VFD015FP4EA-XXX	4.2A						
VFD022FP4EA-XXX	5.5A						
VFD037FP4EA-XXX	8.5A						
VFD040FP4EA-XXX	10.5A						
VFD055FP4EA-XXX	13A						
VFD075FP4EA-XXX	18A						
VFD110FP4EA-XXX	24A	RF006FP00A					
VFD150FP4EA-XXX	32A						
VFD185FP4EA-XXX	38A						
VFD220FP4EA-XXX	45A						
VFD300FP4EA-XXX	60A	RF002FP00A					
VFD370FP4EA-XXX	73A						
VFD450FP4EA-XXX	91A	-		≤ 10K		≤ 4K	
VFD550FP4EA-XXX	110A	-					
VFD750FP4EA-XXX	150A	-					
VFD900FP4EA-XXX	180A	-	≤ 9K				

NOTE

- *1: When the length of the cable is longer than 25m, do not install the zero phase reactors listed in the table above.
- *2: To comply with the C1 specifications, an EMC magnetic core needs to be installed on the output side.
- *3: For frame A~C to comply with EN 61800-3 C1 regulations (when the length of the cable is less than 25m, it complies with the C1 regulations.), a zero phase reactor has to be installed on the output side. Pass the three UVW cables through the zero phase reactor. But do not pass the earthing cable and the pig tail of the insulation through the zero phase reactor.
- *4: C2 specifications do not require installing a zero phase reactor.
- *5: There is no need to install external zero phase reactor at 45/55/75/90KW for meeting the EN61800-3 (Class C2/C1) standard.

EMC Filter Installation

All electrical equipment, including AC motor drives, will generate high-frequency/ low-frequency noise and will interfere with peripheral equipment by radiation or conduction when in operation.

We assure that it can comply with following rules when AC motor drive and EMC filter are installed and wired according to user manual:

- EN61000-6-4
- EN61800-3
- EN55011 Class A Group 1

General precaution

To ensure the EMC filter reaches its best interference elimination performance, please follow below notice for installation and wiring:

- ☑ All the cables should be divided into several classifications, and kept away from each other. The metal layer inside the control cabinet can separate the cables as well. For susceptible cables (Class 1), there should always be an uninterrupted partition between the two terminals. The following classifications (Class 1~4) are recommended:
 - Class 1: Susceptible cables that will be interfered easily. (e.g. low-voltage/ high-speed signal cable, control cable, data cable...)
 - Class 2: Cables that will be interfered easily. (e.g. low-speed communication cable, low-voltage (24V) power cable...)
 - Class 3: Disturbance cable. (e.g. R.S.T. power input cable)
 - Class 4: Strong disturbance cable. (e.g. U.V.W. motor output cable)
 - Below is recommended cables and its installation clearance:

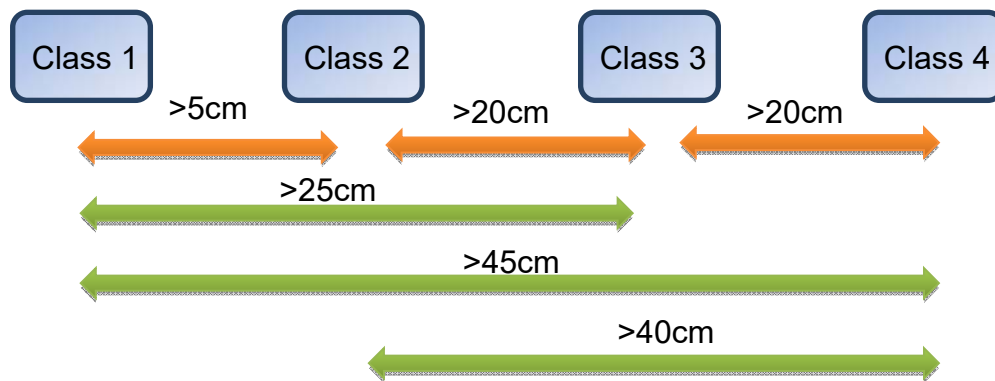

- ☑ If the installation distance could not meet the above separation requirement, please connect zero-phase reactor to the Class 4 cable in series, and use shielding cable or connect core in series to the Class 1 cable.
- ☑ When the installation distance of different cables could not meet the separation requirement, the cables should be placed orthogonality. For example, the filtered cable should be away from non-filtered cable; signal cable, data cable and filtered cable can only be placed orthogonality with non-filtered cable.
- ☑ All the cables should be used as short as possible.
- ☑ For extra cables, please remove it or ground it on each end, so as to avoid floating connection.
- ☑ The motor cable should be away from other data cables that connect to the motor (e.g. encoder line or motor temperature sensors...).
- ☑ Please place the cable on the metal plate, do not hang it in the air.

- ☑ It is recommended to use independent isolated transformer to segregate susceptible equipment from equipment with stronger interference.
- ☑ The RC filter is required for magnetic contactor coil, relay and solenoid valve to eliminate the high-frequency radiation interference (e.g. RC elements or varistors with AC coils and free-wheeling diodes or varistors for DC coils) that generates from ON/OFF of the unit. All these protection circuit should be close by the coil.
- ☑ Make sure the cover, equipment and accessories that installed inside the control cabinet (e.g. motor drive, filter...) are installed with good-conductivity mounting plate, and are connected to the cabinet frame with well connection and largest contact area. Most of all, the wiring should be connected to the PE and EMC isolation bar.
- ☑ To build up grounding system, please remove cover that with protective layer or anodic treatment on its connection, or connect it to non-conductive layer by a special metal sheet before connecting to the AC driver.
- ☑ Please wire as short as possible. Metal plate should be grounded. The cover of EMC filter and AC motor drive or grounding should be fixed on the metal plate and the contact area should be as large as possible.

Choose suitable motor cable and precautions

It is recommended to use isolated motor wires, as well as the signal wires and data wires.

The recommended specification of the shielding wire can be selected from the three types of shielding wire in Figure 1. (The left figure is a symmetric three-phase power cord with symmetric PE wires. The middle figure is a three-phased power cord with a separated PE wire. The right figure is the asymmetric three-phase power cord with a PE wire.)

The appropriate size of the power cord should be based on the rated current. Use of high density braided shielding prevents electromagnetic noise that results from high frequency signals, as well as prevents external sources from interfering with signal transmissions. Therefore we recommend two types shielded cables:

- Braided copper shielding of 85% density or more (as shown in figure 2a)
- 100% Wrapped in aluminum foil/ copper foil inside and in braided shielding of 80% or more outside (as shown in figure 2b)

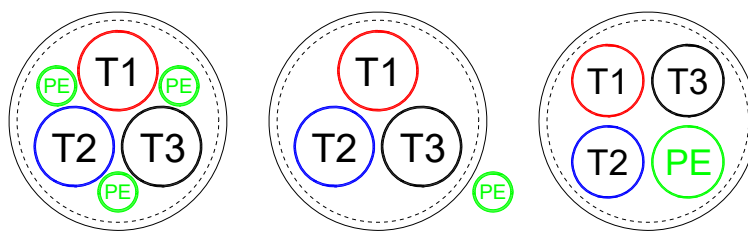

Figure 1 Types shielded cables recommended

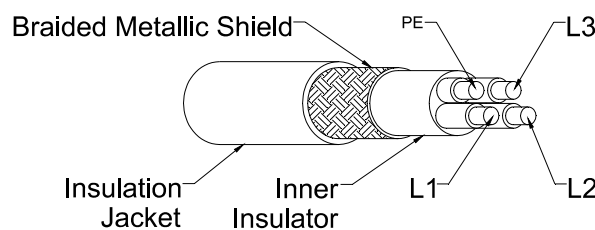

Figure 2a

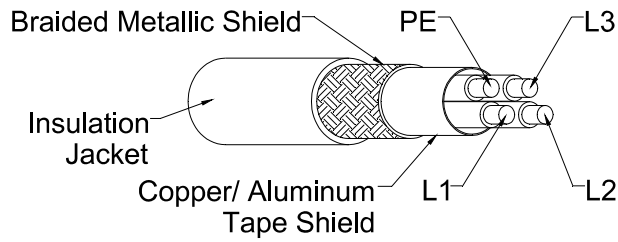

Figure 2b

Precautions for motor cable installation

Improper installation and choice of motor cable will affect the performance of EMC filter. Be sure to observe the following precautions when selecting motor cable. The shielded layers of motor cable need to be grounded by using omega clips or pig tail. If omega clips are being used, the shielded layers need to have a 360-degree contact with the motor and the PE on motor drive.

If a pig tail is being used for grounding, the length of the pig tail cannot be more than 5 times of the wire size (WVW wire sizing)

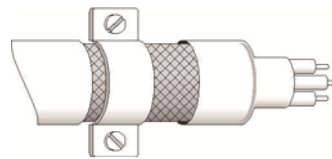

Figure 3

Zero phase reactor Dimensions

Unit: mm

<p>Frame A RF010FP00A</p>	<p>Frame B RF006FP00A</p>
<p>Frame C RF002FP00A</p>	

EMC C1 with zero phase reactor installation

Frame A

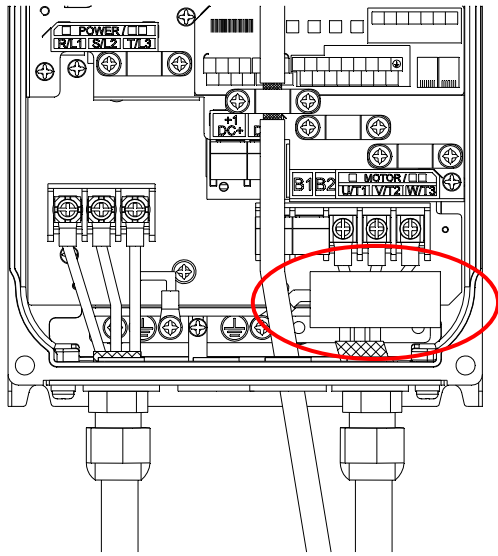

Frame B

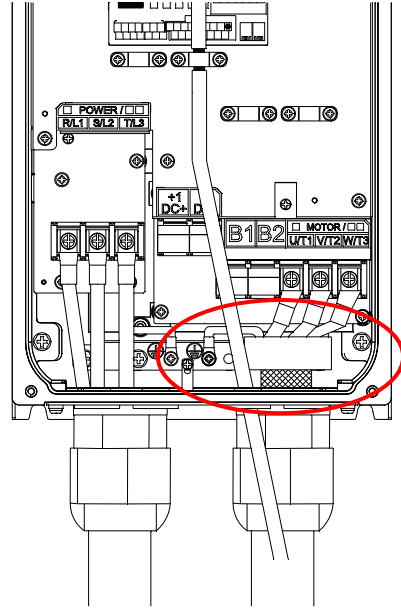

Frame C

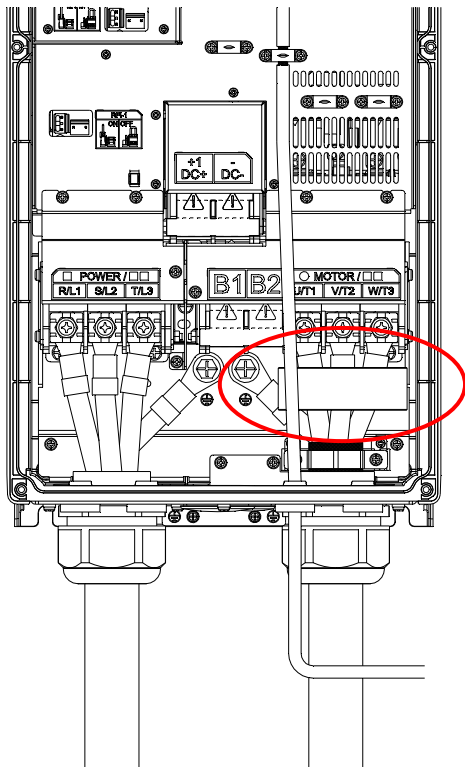

7-7 Panel Mounting (MKC-KPPK)

For MKC-KPPK model, user can choose wall mounting or embedded mounting, protection level is IP66. It is applicable for the digital keypads (KPC-CC02).

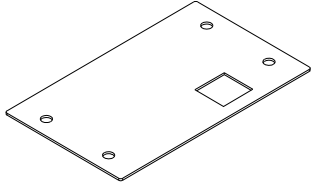
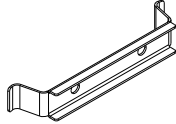
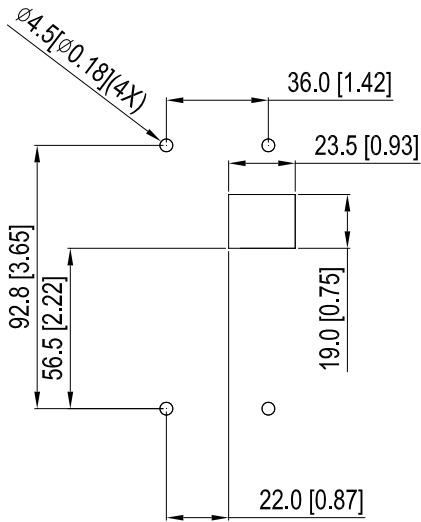
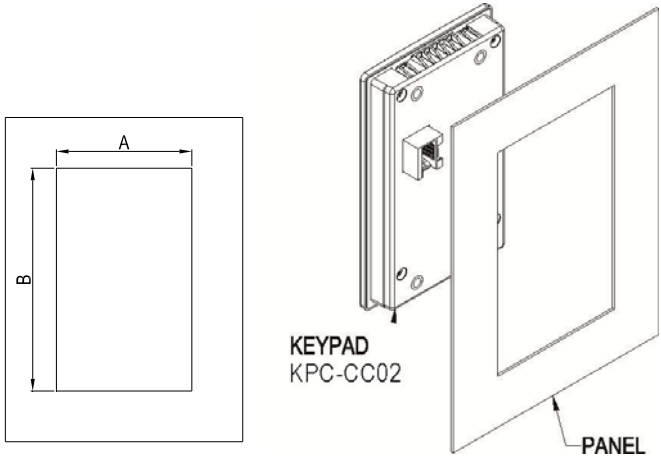
Wall Mounting		Embedded Mounting													
accessories*1 		accessories*2 													
Screw *4 ~M4*p 0.7 *L8mm Torque: 10~12kg-cm / [8.7~10.4lb-in.] / [1.0~1.2Nm]		Screw *4 ~M4*p 0.7 *L8mm Torque: 10~12kg-cm / [8.7~10.4lb-in.] / [1.0~1.2Nm]													
Panel cutout dimension Unit: mm [inch]		Panel cutout dimension Unit: mm [inch]													
		Normal cutout dimension <table border="1"> <thead> <tr> <th>Panel thickness</th> <th>1.2mm</th> <th>1.6mm</th> <th>2.0mm</th> </tr> </thead> <tbody> <tr> <td>A</td> <td colspan="3">66.4 [2.614]</td> </tr> <tr> <td>B</td> <td>110.2 [4.339]</td> <td>111.3 [4.382]</td> <td>112.5 [4.429]</td> </tr> </tbody> </table>		Panel thickness	1.2mm	1.6mm	2.0mm	A	66.4 [2.614]			B	110.2 [4.339]	111.3 [4.382]	112.5 [4.429]
Panel thickness	1.2mm	1.6mm	2.0mm												
A	66.4 [2.614]														
B	110.2 [4.339]	111.3 [4.382]	112.5 [4.429]												
		*Deviation: ±0.15mm /±0.0059inch													
		Cutout dimension (Waterproof level: IP66) <table border="1"> <thead> <tr> <th>Panel thickness</th> <th>1.2mm</th> <th>1.6mm</th> <th>2.0mm</th> </tr> </thead> <tbody> <tr> <td>A</td> <td colspan="3">66.4 [2.614]</td> </tr> <tr> <td>B</td> <td colspan="3">110.8 [4.362]</td> </tr> </tbody> </table>		Panel thickness	1.2mm	1.6mm	2.0mm	A	66.4 [2.614]			B	110.8 [4.362]		
Panel thickness	1.2mm	1.6mm	2.0mm												
A	66.4 [2.614]														
B	110.8 [4.362]														
		*Deviation: ±0.15mm /±0.0059inch													

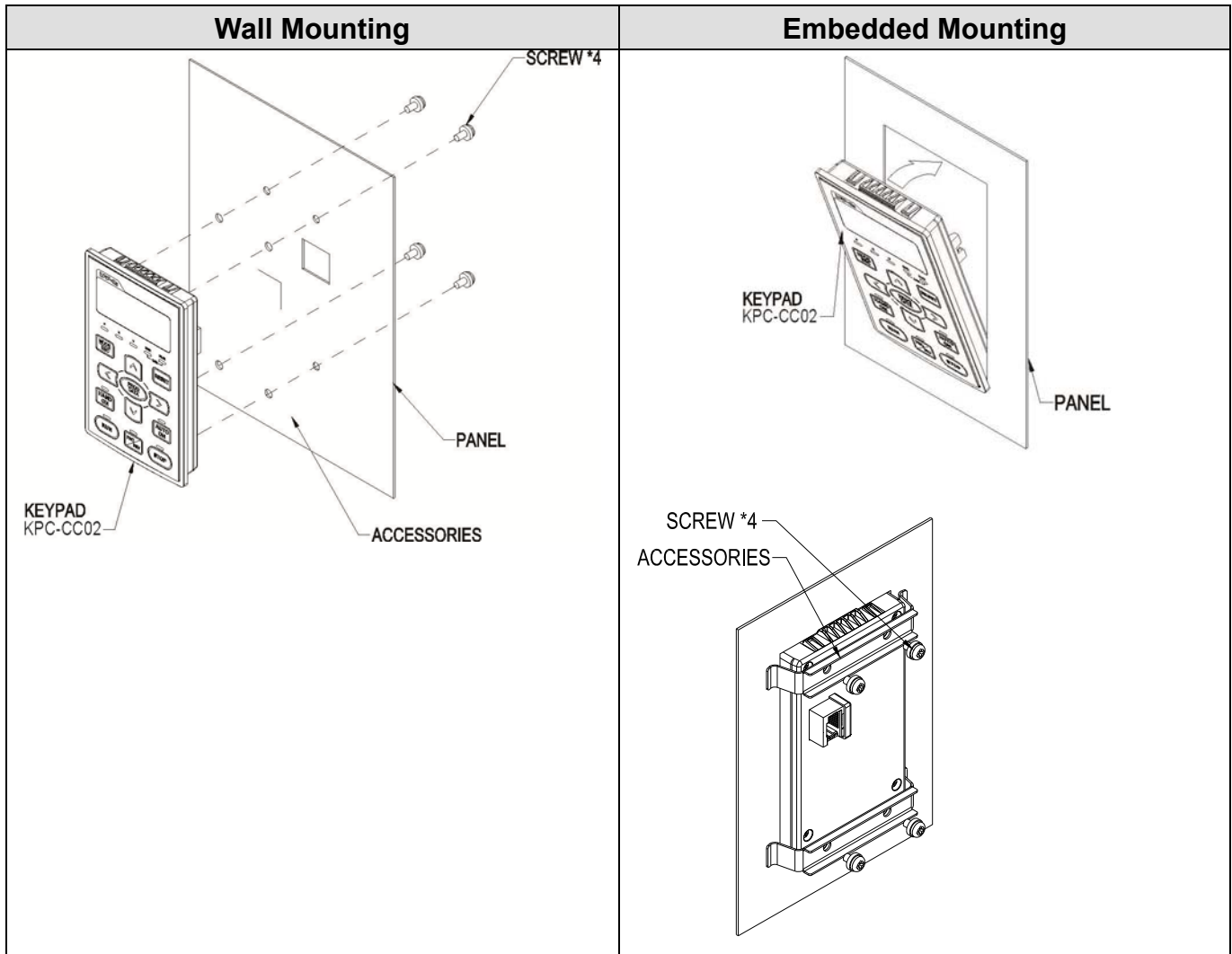

7-8 Fan Kit

■ Frames of heatsink fans:

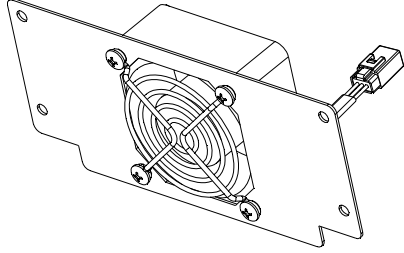
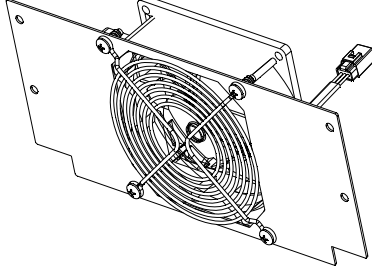
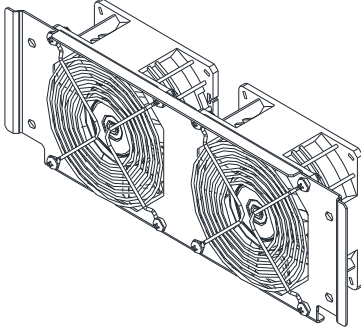
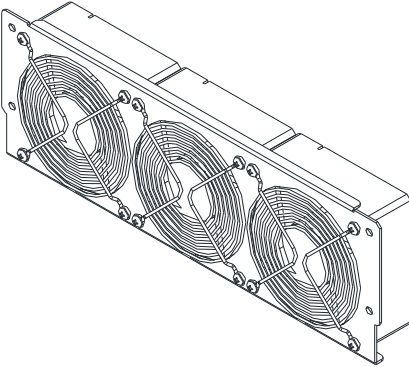
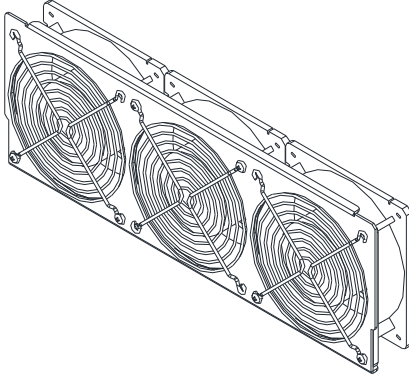
<p>Frame A</p> <p>Applicable Model</p> <p>VFD022FP4EA-41, VFD022FP4EA-52, VFD022FP4EA-52S, VFD037FP4EA-41, VFD037FP4EA-52, VFD037FP4EA-52S, VFD040FP4EA-41, VFD040FP4EA-52, VFD040FP4EA-52S, VFD055FP4EA-41, VFD055FP4EA-52, VFD055FP4EA-52S, VFD075FP4EA-41, VFD075FP4EA-52, VFD075FP4EA-52S</p>	<p>Heat sink Fan Model 『MKFP-AFKM』</p> 
<p>Frame B</p> <p>Applicable Model</p> <p>VFD110FP4EA-41, VFD110FP4EA-52, VFD110FP4EA-52S, VFD150FP4EA-41, VFD150FP4EA-52, VFD150FP4EA-52S, VFD185FP4EA-41, VFD185FP4EA-52, VFD185FP4EA-52S, VFD220FP4EA-41, VFD220FP4EA-52, VFD220FP4EA-52S</p>	<p>Heat sink Fan Model 『MKFP-BFKM』</p> 
<p>Frame C</p> <p>Applicable Model</p> <p>VFD300FP4EA-41, VFD300FP4EA-52, VFD300FP4EA-52S, VFD370FP4EA-41, VFD370FP4EA-52, VFD370FP4EA-52S</p>	<p>Heat sink Fan Model 『MKFP-CFKM』</p> 
<p>Frame D0</p> <p>Applicable Model</p> <p>VFD450FP4EA-41, VFD450FP4EA-52, VFD550FP4EA-52, VFD550FP4EA-41, VFD450FP4EA-52S, VFD550FP4EA-52S</p>	<p>Heat sink Fan Model 『MKFP-D0FKM』</p> 
<p>Frame D</p> <p>Applicable Model</p> <p>VFD750FP4EA-41, VFD750FP4EA-52, VFD750FP4EA-52S, VFD900FP4EA-52, VFD900FP4EA-41, VFD900FP4EA-52S</p>	<p>Heat sink Fan Model 『MKFP-DFKM』</p> 

■ Frames of capacitor fans:

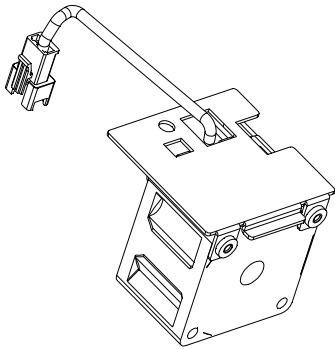
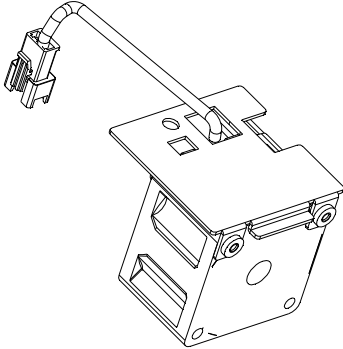
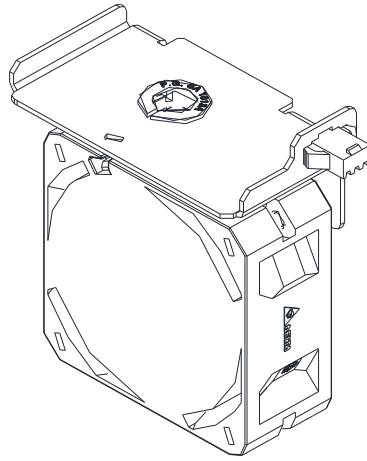
<p>Frame A</p> <p>Applicable Model VFD007FP4EA-41, VFD007FP4EA-52, VFD007FP4EA-52S, VFD015FP4EA-41, VFD015FP4EA-52, VFD015FP4EA-52S, VFD022FP4EA-41, VFD022FP4EA-52, VFD022FP4EA-52S, VFD037FP4EA-41, VFD037FP4EA-52, VFD037FP4EA-52S, VFD040FP4EA-41, VFD040FP4EA-52, VFD040FP4EA-52S, VFD055FP4EA-41, VFD055FP4EA-52, VFD055FP4EA-52S, VFD075FP4EA-41, VFD075FP4EA-52, VFD075FP4EA-52S</p>	<p>Capacitor Fan Model 『MKFP-AFKB』</p> 
<p>Frame B</p> <p>Applicable Model VFD110FP4EA-41, VFD110FP4EA-52, VFD110FP4EA-52S, VFD150FP4EA-41, VFD150FP4EA-52, VFD150FP4EA-52S, VFD185FP4EA-41, VFD185FP4EA-52, VFD185FP4EA-52S, VFD220FP4EA-41, VFD220FP4EA-52, VFD220FP4EA-52S</p>	<p>Capacitor Fan Model 『MKFP-BFKB』</p> 
<p>Frame C</p> <p>Applicable Model VFD300FP4EA-41, VFD300FP4EA-52, VFD300FP4EA-52S, VFD370FP4EA-41, VFD370FP4EA-52, VFD370FP4EA-52S</p>	<p>Capacitor Fan Model 『MKFP-CFKB』</p> 
<p>Frame D0</p> <p>Applicable Model VFD450FP4EA-41, VFD450FP4EA-52, VFD450FP4EA-52S, VFD550FP4EA-41, VFD550FP4EA-52, VFD550FP4EA-52S</p>	
<p>Frame D</p> <p>Applicable Model VFD750FP4EA-41, VFD750FP4EA-52, VFD750FP4EA-52S, VFD900FP4EA-41, VFD900FP4EA-52, VFD900FP4EA-52S</p>	

■ Fan Removal

Frame A

Model 『MKFP-AFKM』 : Heat Sink Fan

Applicable model

VFD022FP4EA-41, VFD022FP4EA-52, VFD022FP4EA-52S,
VFD037FP4EA-41, VFD037FP4EA-52, VFD037FP4EA-52S,
VFD040FP4EA-41, VFD040FP4EA-52, VFD040FP4EA-52S,
VFD055FP4EA-41, VFD055FP4EA-52, VFD055FP4EA-52S,
VFD075FP4EA-41, VFD075FP4EA-52, VFD075FP4EA-52S

1. Refer to Figure 1, loosen the 4 screws then remove the fan kit.
2. Screw torque: 14~16kg-cm / [12.2~13.9lb-in.]

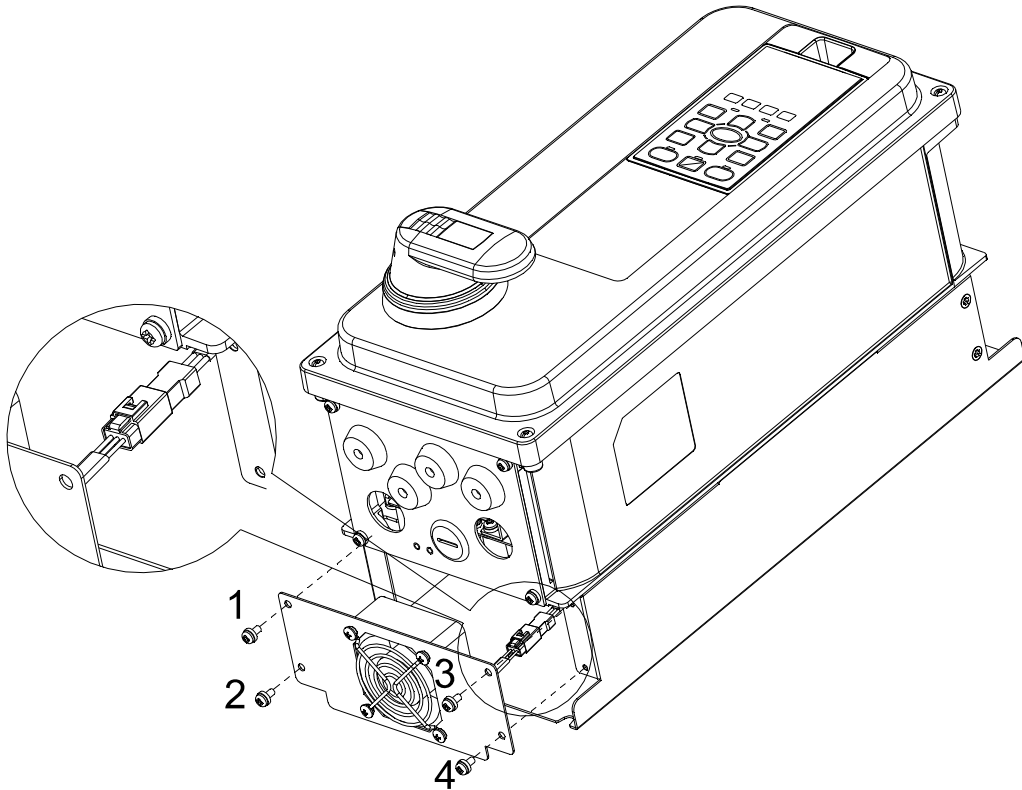

Figure 1

Frame A

Model 『MKFP-AFKB』 : Capacitor Fan

Applicable model

VFD007FP4EA-41, VFD007FP4EA-52, VFD007FP4EA-52S,
 VFD015FP4EA-41, VFD015FP4EA-52, VFD015FP4EA-52S,
 VFD022FP4EA-41, VFD022FP4EA-52, VFD022FP4EA-52S,
 VFD037FP4EA-41, VFD037FP4EA-52, VFD037FP4EA-52S,
 VFD040FP4EA-41, VFD040FP4EA-52, VFD040FP4EA-52S,
 VFD055FP4EA-41, VFD055FP4EA-52, VFD055FP4EA-52S,
 VFD075FP4EA-41, VFD075FP4EA-52, VFD075FP4EA-52S

1. Press the hook in the top of digital keypad, then rotate to remove the digital keypad (refer to Figure 2)
2. Screw 1~4 torque: 14~16kg-cm / [12.2~13.9lb-in.]
3. Loosen the screws 8~13 then remove the fan kit.(refer to Figure 3)
4. Screw 8~12 torque: 6~8kg-cm / [5.2~6.9lb-in.]; Screw 13 torque: 12~14kg-cm / [10.4~12.2lb-in.]

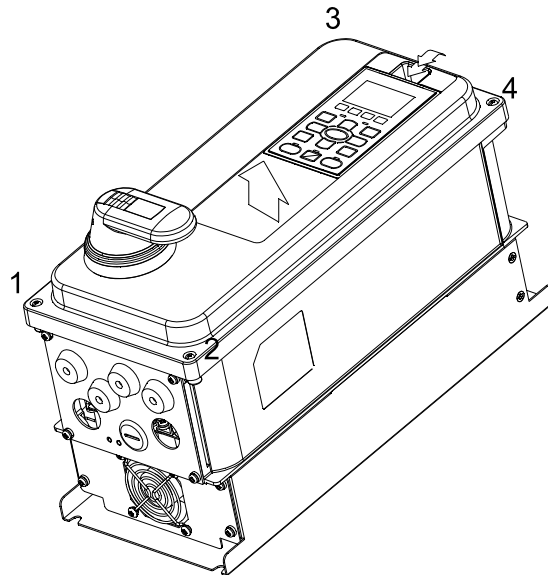

Figure 2

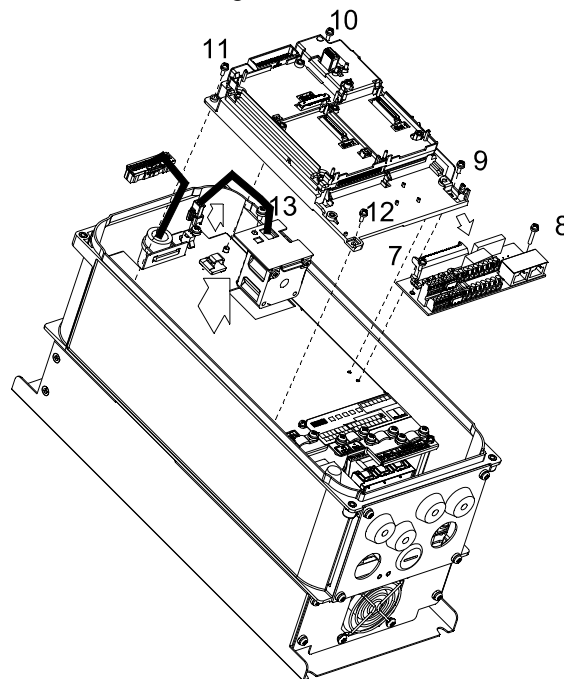

Figure 3

Frame B

Model 『MKFP-BFKM』 : Heat Sink Fan

Applicable model

VFD110FP4EA-41, VFD110FP4EA-52, VFD110FP4EA-52S,
VFD150FP4EA-41, VFD150FP4EA-52, VFD150FP4EA-52S,
VFD185FP4EA-41, VFD185FP4EA-52, VFD185FP4EA-52S,
VFD220FP4EA-41, VFD220FP4EA-52, VFD220FP4EA-52S

1. Refer to Figure 1, loosen the 4 screws then remove the fan kit.
2. Screw torque: 14~16kg-cm / [12.2~13.9lb-in.]

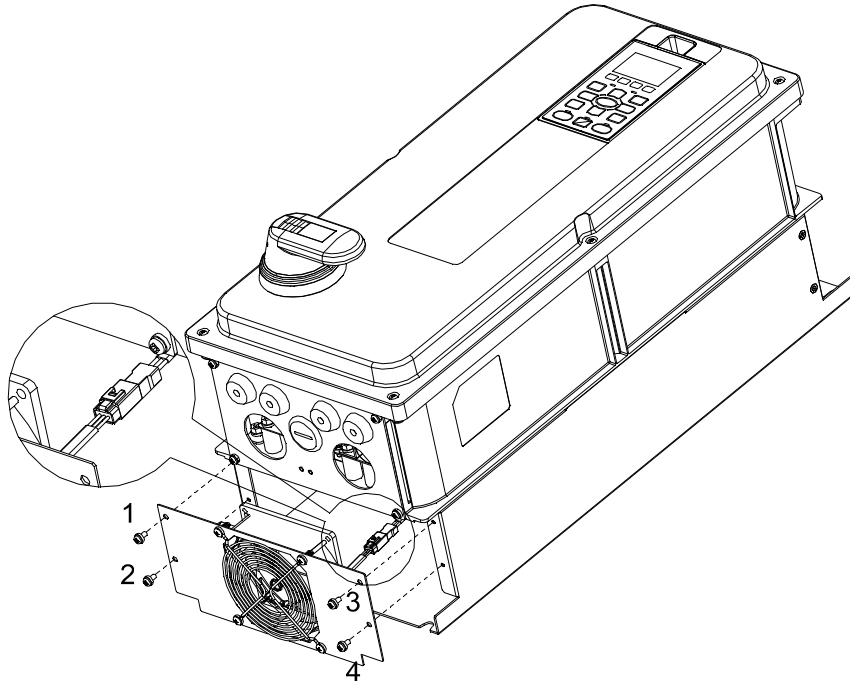

Figure 1

Frame B

Model 『MKFP-BFKB』 : Capacitor Fan

Applicable model

VFD110FP4EA-41, VFD110FP4EA-52, VFD110FP4EA-52S,
VFD150FP4EA-41, VFD150FP4EA-52, VFD150FP4EA-52S,
VFD185FP4EA-41, VFD185FP4EA-52, VFD185FP4EA-52S,
VFD220FP4EA-41, VFD220FP4EA-52, VFD220FP4EA-52S

1. Press the hook in the top of digital keypad, then rotate to remove the digital keypad (refer to Figure 2)
2. Screw 1~6 torque: 14~16kg-cm / [12.2~13.9lb-in.]
3. Loosen the screws 8~13 then remove the fan kit.(refer to Figure 3)
4. Screw 8~12 torque: 6~8kg-cm / [5.2~6.9lb-in.]; Screw 13 torque: 12~14kg-cm / [10.4~12.2lb-in.]

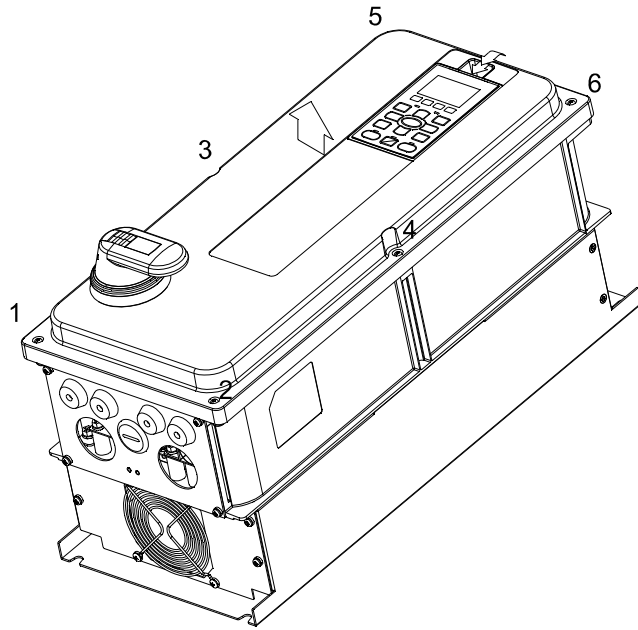

Figure 2

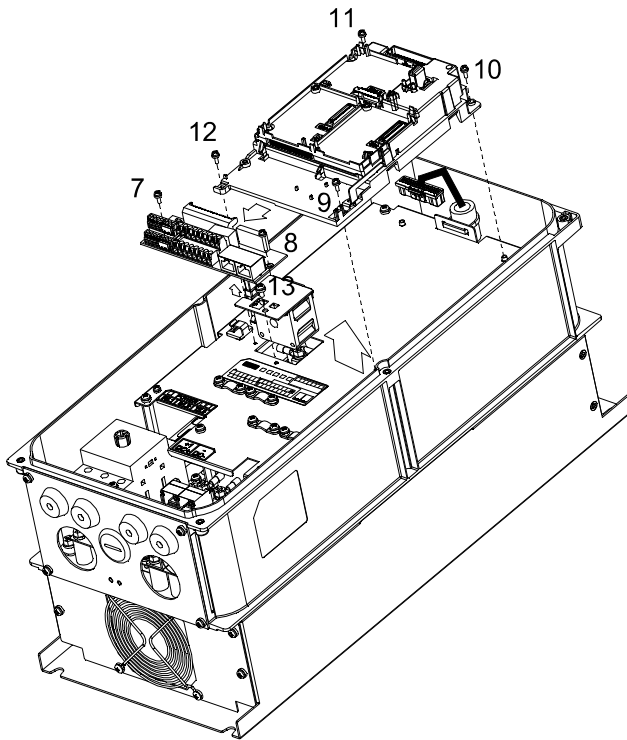

Figure 3

Frame C

Model 『MKFP-CFKM』 : Heat Sink Fan

Applicable model

VFD300FP4EA-41, VFD300FP4EA-52, VFD300FP4EA-52S,
VFD370FP4EA-41, VFD370FP4EA-52, VFD370FP4EA-52S

1. Refer to Figure 1, loosen the 4 screws then remove the fan kit.
2. Screw torque: 24~26kg-cm / [20.8~22.6lb-in.]

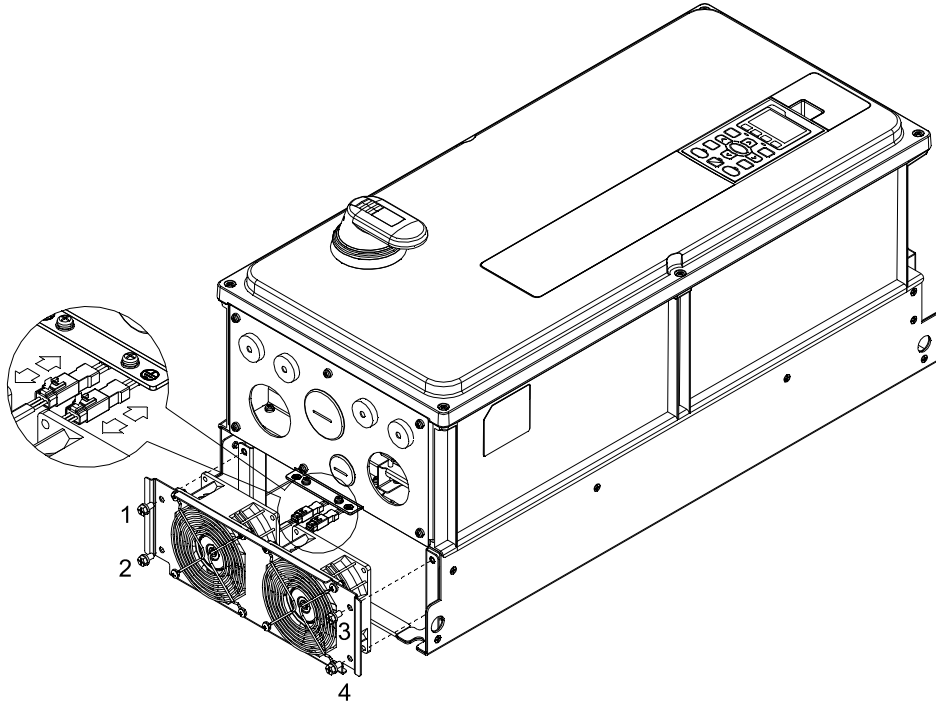

Figure 1

Frame C

Model 『MKFP-CFKB』 : Capacitor Fan

Applicable model

VFD300FP4EA-41, VFD300FP4EA-52, VFD300FP4EA-52S,
VFD370FP4EA-41, VFD370FP4EA-52, VFD370FP4EA-52S

1. Press the hook in the top of digital keypad, then rotate to remove the digital keypad (refer to Figure 2)
2. Screw 1~6 torque: 14~16kg-cm / [12.1~13.9lb-in.]
3. Loosen the screw 7 then remove the fan kit.(refer to Figure 3)
4. Screw 7 torque: 12~15kg-cm / [10.4~13lb-in.]

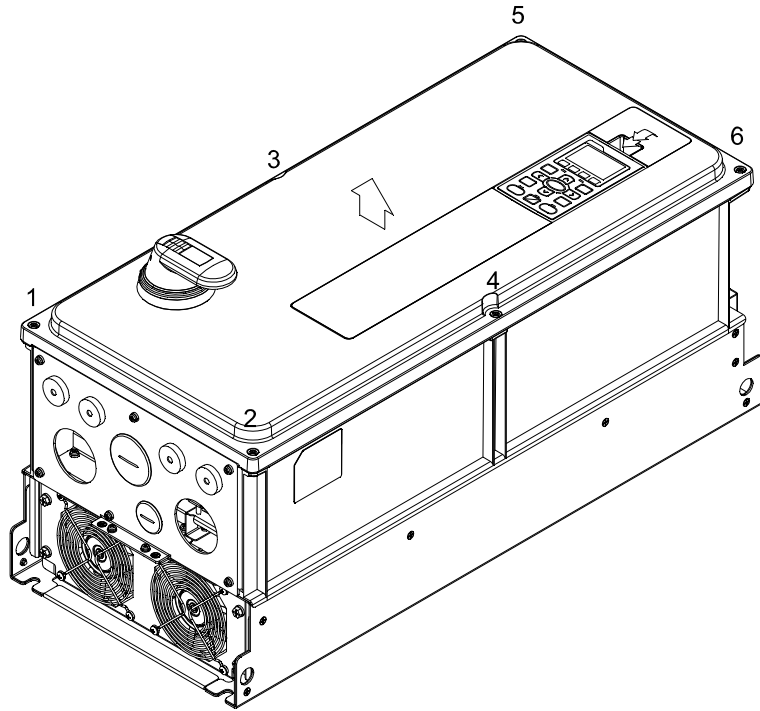

Figure 2

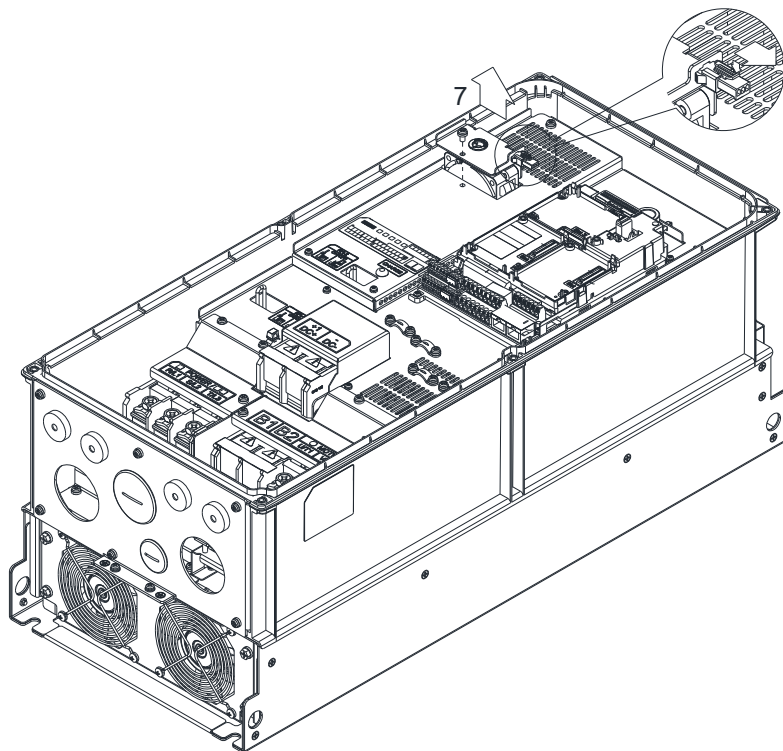

Figure 3

Frame D0

Model 『MKFP-D0FKM』 : Heat Sink Fan

Applicable model

VFD450FP4EA-41, VFD450FP4EA-52, VFD450FP4EA-52S,
VFD550FP4EA-41, VFD550FP4EA-52, VFD550FP4EA-52S

1. Loosen the screw and remove the fan kit. Screw torque: 24~26kgf-cm / [20.8~22.6lb-in]
2. Before removing the fan, remove the cover by using a slotted screwdriver. (refer to Figure 1)

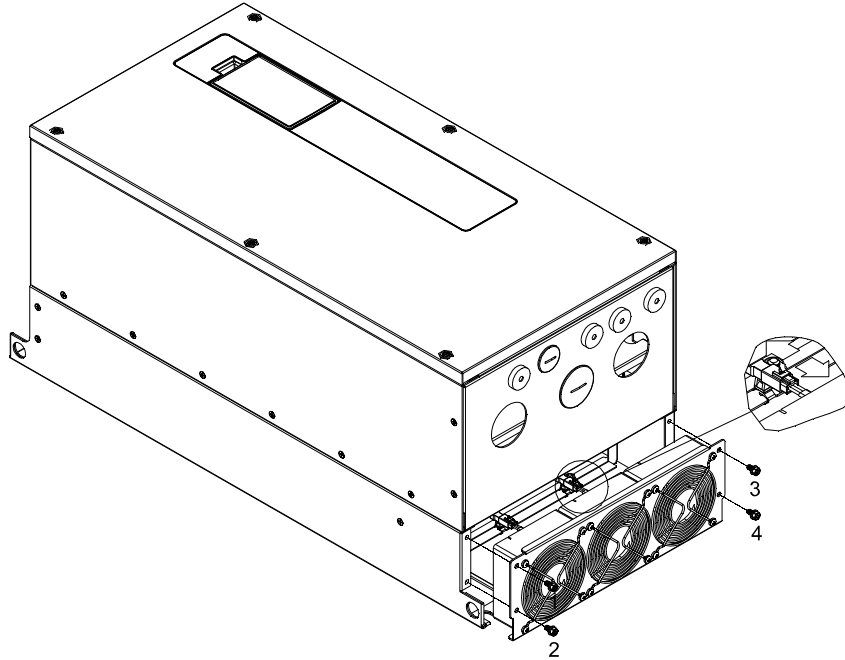

Figure 1

Frame D0

Model 『MKFP-CFKB』 : Capacitor Fan

Applicable model

VFD450FP4EA-41, VFD450FP4EA-52, VFD450FP4EA-52S,
VFD550FP4EA-41, VFD550FP4EA-52, VFD550FP4EA-52S

1. Press the hook in the top of digital keypad, then rotate to remove the digital keypad (refer to Figure 2)
2. Screw 1~6 torque: 14~16kg-cm / [12.1~13.9lb-in.]
3. Loosen the screw 7 then remove the fan kit.(refer to Figure 3)
4. Screw 7 torque: 12~15kg-cm / [10.4~13lb-in.]

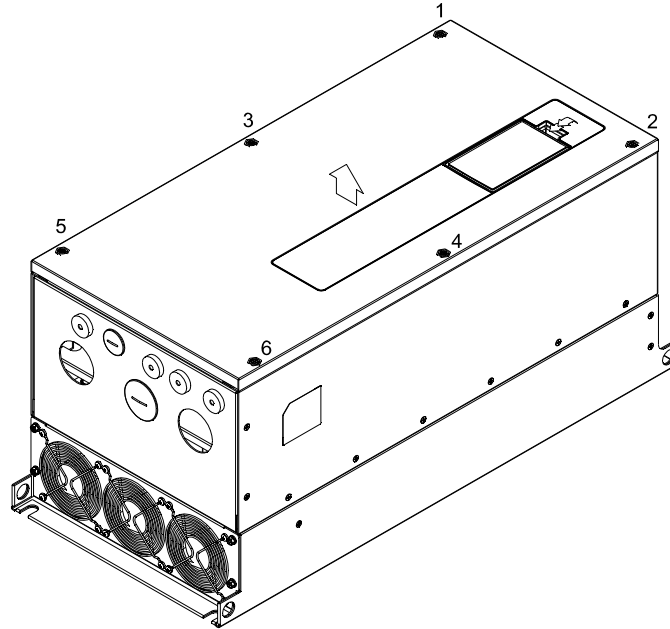

Figure 2

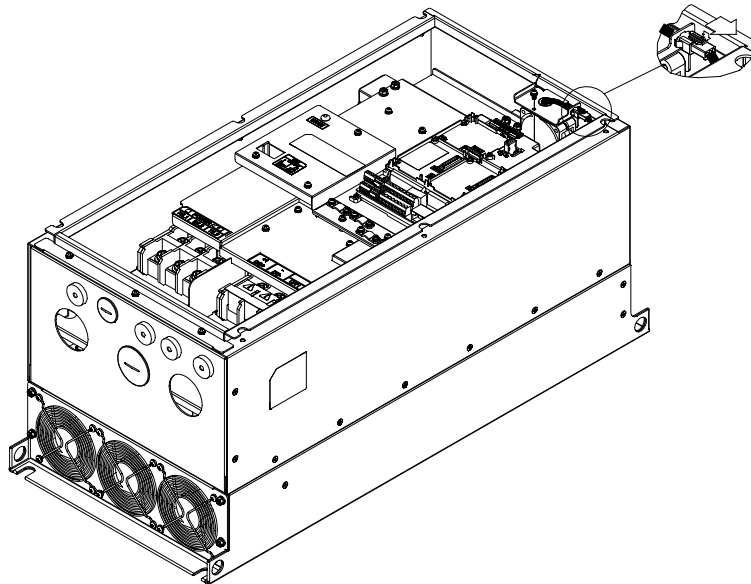

Figure 3

Frame D

Model 『MKFP-DFKM』 : Heat Sink Fan

Applicable model

VFD750FP4EA-41, VFD750FP4EA-52, VFD750FP4EA-52S,
VFD900FP4EA-41, VFD900FP4EA-52, VFD900FP4EA-52S

1. Loosen the screw and remove the fan kit. Screw torque: 14~16kg-cm / [12.1~13.9lb-in.]
2. Before removing the fan, remove the cover by using a slotted screwdriver. (refer to Figure 1)

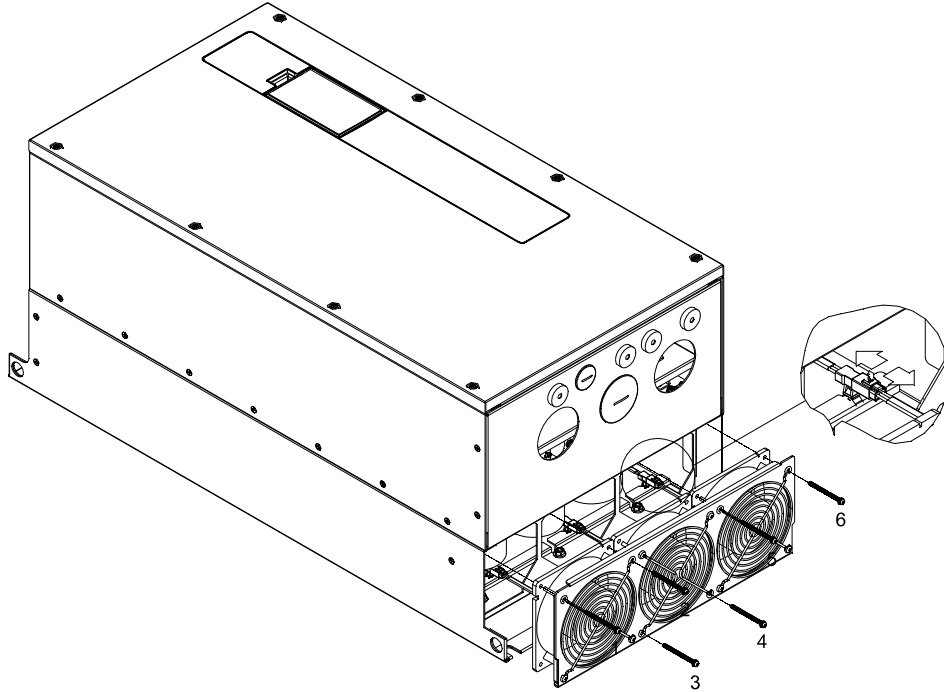

Figure 1

Frame D

Model 『MKFP-CFKB』 : Capacitor Fan

Applicable model

VFD750FP4EA-41, VFD750FP4EA-52, VFD750FP4EA-52S,
VFD900FP4EA-41, VFD900FP4EA-52, VFD900FP4EA-52S

1. Press the hook in the top of digital keypad, then rotate to remove the digital keypad (refer to Figure 2)
2. Screw 1~8 torque: 14~16kg-cm / [12.1~13.9lb-in.]
3. Loosen the screw 9 then remove the fan kit.(refer to Figure 3)
4. Screw 9 torque: 12~15kg-cm / [10.4~13lb-in.]

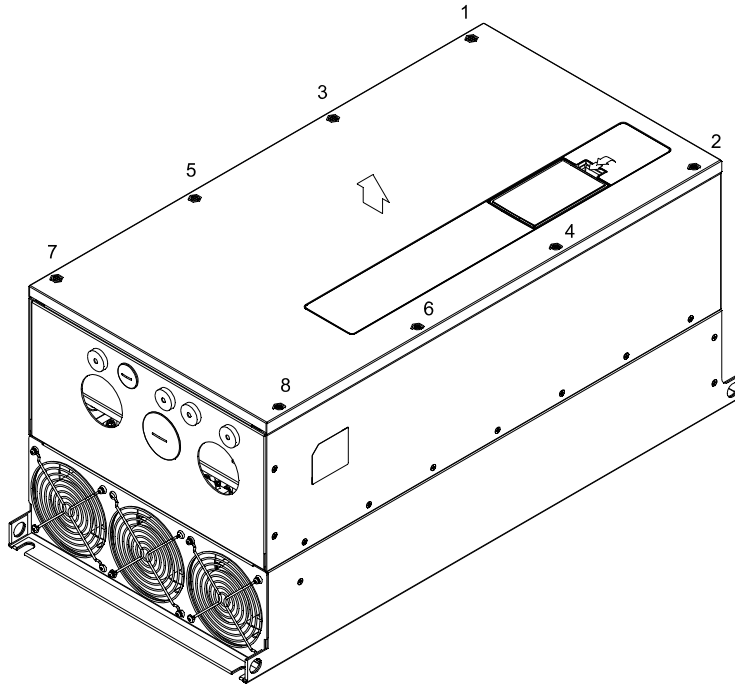

Figure 2

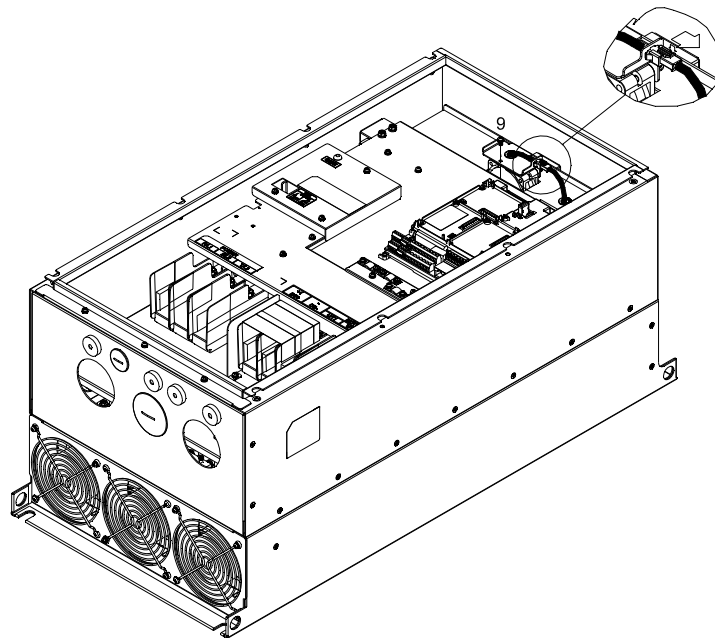

Figure 3

7-9 USB/RS-485 Communication Interface IFD6530

Warning

- ✓ Please thoroughly read this instruction sheet before installation and putting it into use.
- ✓ The content of this instruction sheet and the driver file may be revised without prior notice. Please consult our distributors or download the most updated instruction/driver version at http://www.delta.com.tw/product/em/control/cm/control_cm_main.asp

1. Introduction

IFD6530 is a convenient RS-485-to-USB converter, which does not require external power-supply and complex setting process. It supports baud rate from 75 to 115.2Kbps and auto switching direction of data transmission. In addition, it adopts RJ-45 in RS-485 connector for users to wire conveniently. And its tiny dimension, handy use of plug-and-play and hot-swap provide more conveniences for connecting all DELTA IABG products to your PC.

Applicable Models: All DELTA IABG products.

(Application & Dimension)

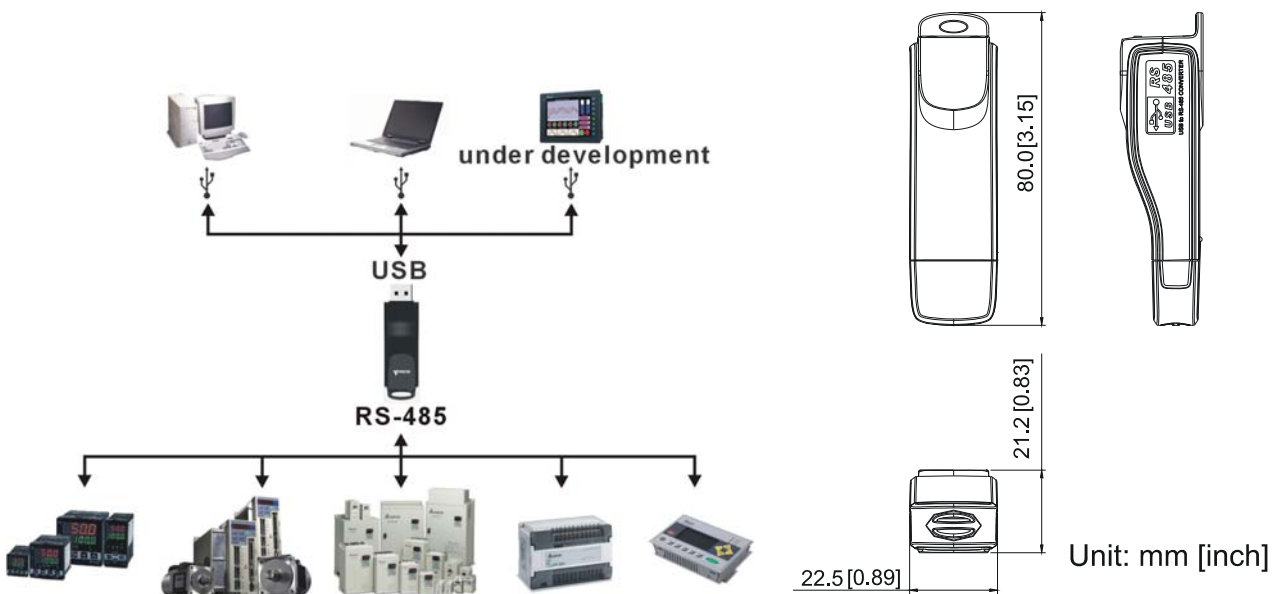

2. Specifications

Power supply	No external power is needed
Power consumption	1.5W
Isolated voltage	2,500VDC
Baud rate	75Kbps, 150Kbps, 300Kbps, 600Kbps, 1,200Kbps, 2,400Kbps, 4,800Kbps, 9,600Kbps, 19,200Kbps, 38,400Kbps, 57,600Kbps, 115,200Kbps
RS-485 connector	RJ-45
USB connector	A type (plug)
Compatibility	Full compliance with USB V2.0 specification
Max. cable length	RS-485 Communication Port: 100 m
Support RS-485 half-duplex transmission	

■ RJ-45

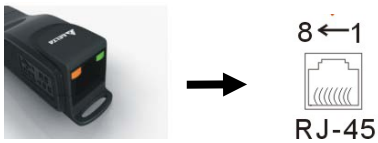

PIN	Description
1	Reserved
2	Reserved
3	GND
4	SG-

PIN	Description
5	SG+
6	GND
7	Reserved
8	+9V

3. Preparations before Driver Installation

Please extract the driver file (IFD6530_Drivers.exe) by following steps. You could find driver file (IFD6530_Drivers.exe) in the CD supplied with IFD6530.

Note: DO NOT connect IFD6530 to PC before extracting the driver file.

STEP 1

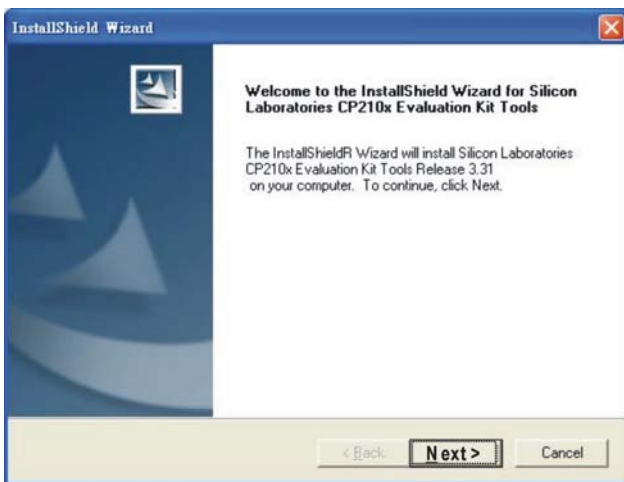

STEP 2

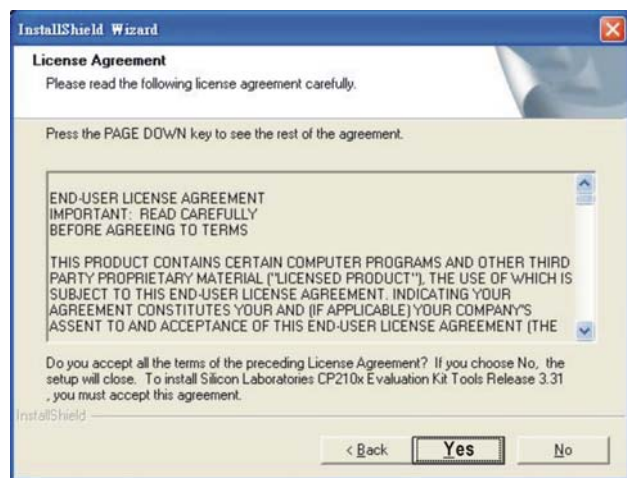

STEP 3



STEP 4



STEP 5

You should have a folder marked SiLabs under drive C. c:\ SiLabs

4. Driver Installation

After connecting IFD6530 to PC, please install driver by following steps.

STEP 1



STEP 2

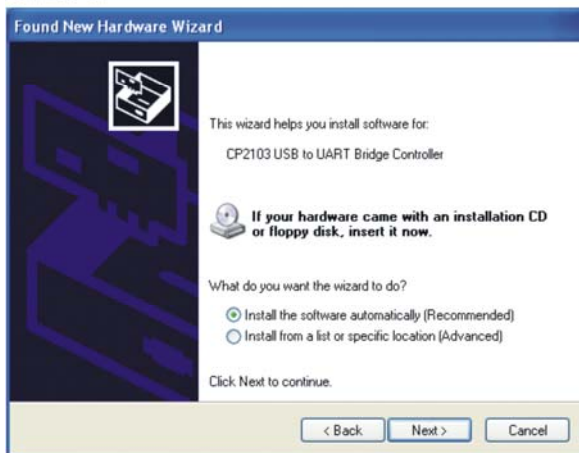

OR

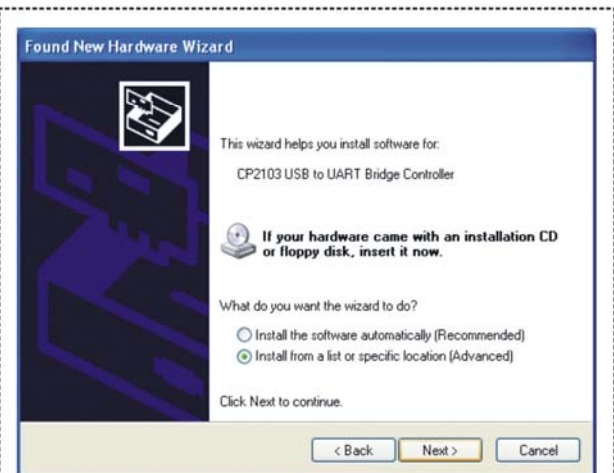

Browse and select directory, or enter
C:\SiLabs\MCU\CP210x\WIN

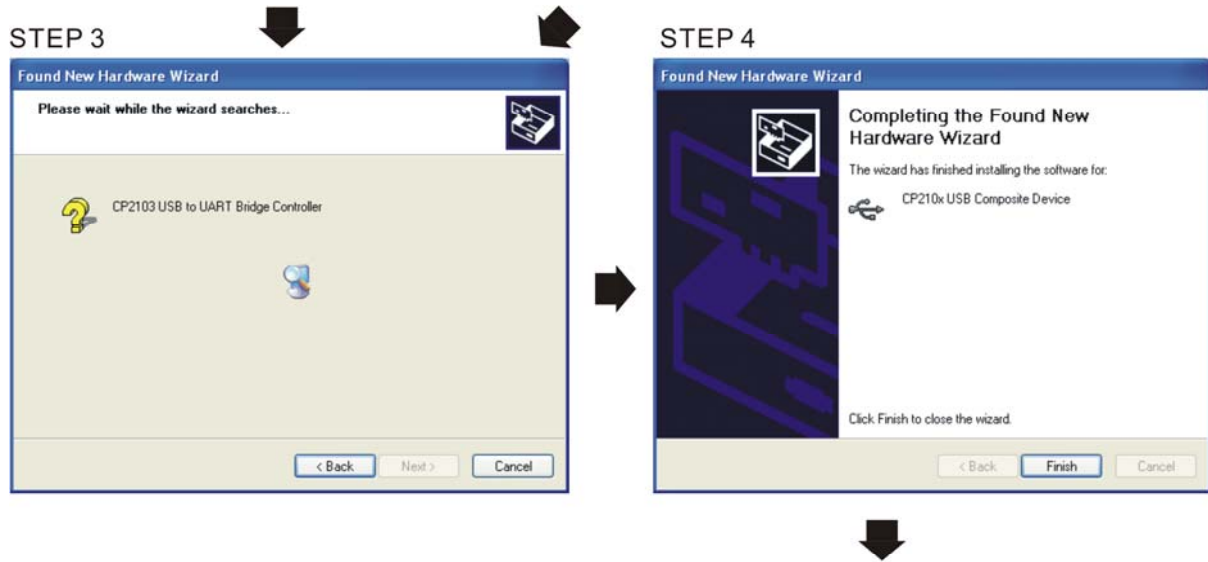

STEP 5
Repeat Step 1 to Step 4 to complete COM PORT setting.

5. LED Display

1. Steady Green LED ON: power is ON.
2. Blinking orange LED: data is transmitting.

Chapter 8 Option Cards

8-1 Option Card Installation

8-2 EMC-D42A (I/O Extension Card)

8-3 EMC-D611A (I/O Extension Card)

8-4 EMC-R6AA (I/O Extension Card)

8-5 EMC-BPS01 (24V Power Extension Card)

8-6 CMC-MOD01 (Communication Extension Card)

8-7 CMC-PD01 (Communication Extension Card)

8-8 CMC-DN01 (Communication Extension Card)

8-9 CMC-EIP01 (Communication Extension Card)

8-10 EMC-COP01 (Communication Extension Card)

8-11 Delta Standard Fieldbus Cables

Please select applicable option cards for your drive or contact local distributor for suggestion. To prevent drive damage during installation, please remove the digital keypad and the cover before wiring. Refer to the following instruction.

8-1 Option Card Installation

8-1-1 Remove the top cover

Frame A & B

Screw Torque: 12~15Kg-cm / [10.4~13lb-in.] / [1.2~1.5 Nm]

1. Remove the keypad (as shown in below figure 2).
2. Loosen the screws, then remove the top cover (as shown in below figure 3).

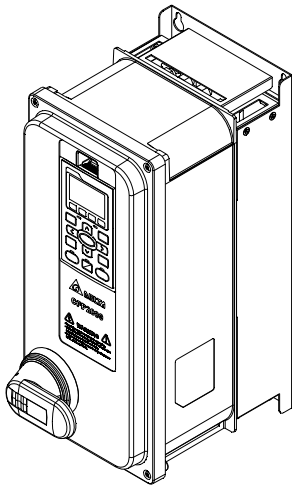

Figure 1

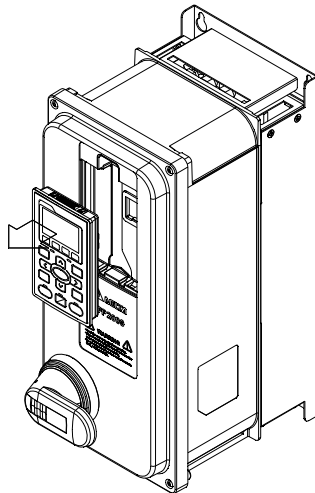

Figure 2

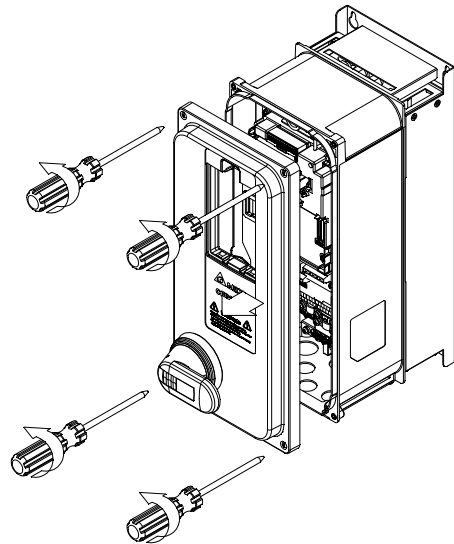

Figure 3

Frame C

Screw Torque: 12~15Kg-cm / [10.4~13lb-in.] / [1.2~1.5 Nm]

1. Remove the keypad (as shown in below figure 2).
2. Loosen the screws, then remove the top cover (as shown in below figure 3).

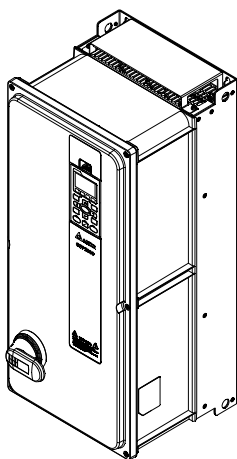

Figure 1

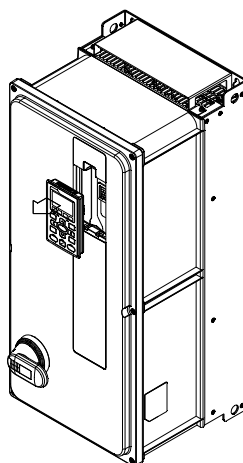

Figure 2

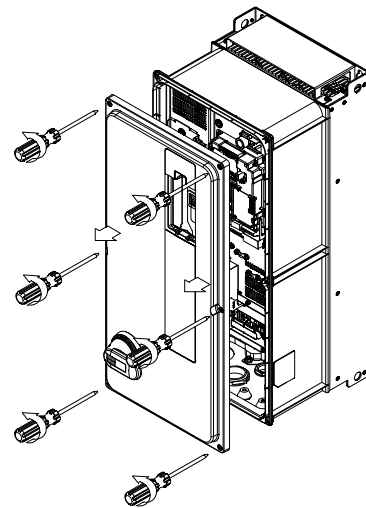

Figure 3

Frame D0~D

Screw Torque: 14~16Kg-cm / [12.1~13.9lb-in.] / [1.4~1.6 Nm]

1. Remove the keypad (as shown in below figure 2).
2. Loosen the screws, then remove the top cover (as shown in below figure 3).

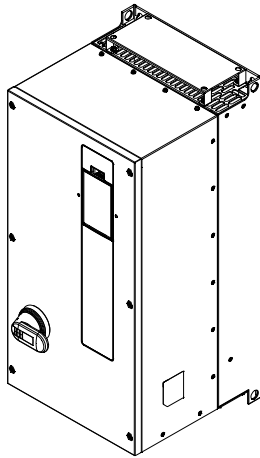

Figure 1

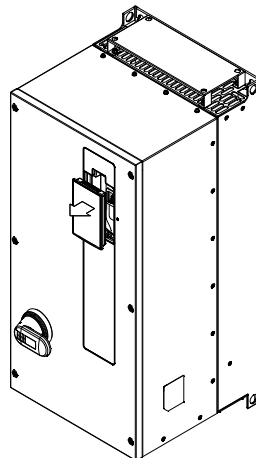

Figure 2

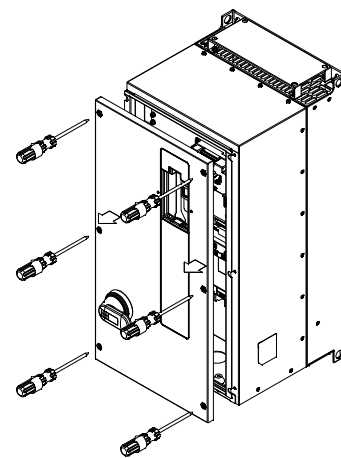
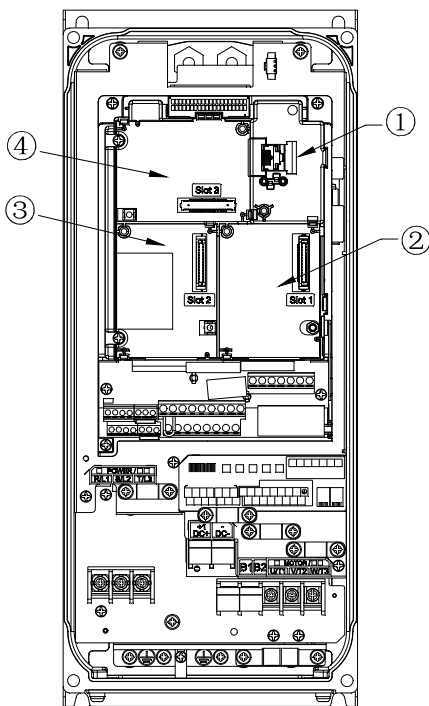

Figure 3

8-1-2 Location to Install Extension Card



1	RJ45 (Socket) for digital keypad KPC-CC02 1. Please refer to CH10 Digital Keypad for more details on KPC-CC02. 2. Please refer to CH10 Digital Keypad for more details on optional accessory RJ45 extension cable.
2	Communication extension card (Slot 1) 1. CMC-MOD01 2. CMC-PD01 3. CMC-DN01 4. CMC-EIP01 5. EMC-COP01
3	PG Card (Slot 2) CFP2000 does not support PG Card.
4	I/O & Relay extension card (Slot 3) 1. EMC-D42A 2. EMC-D611A 3. EMC-R6AA 4. EMC-BPS01

Screws Specification for option card terminals:

EMC-D42A EMC-D611A EMC-BPS01	Wire gauge	24~12AWG / [0.205~3.31mm ²]
	Torque	5Kg-cm / [4.4 lb-in] / [0.5Nm]
EMC-R6AA	Wire gauge	26~16AWG / [0.128~1.31mm ²]
	Torque	8Kg-cm / [6.94 lb-in] / [0.8Nm]

I/O & Relay extension card (Slot 3)

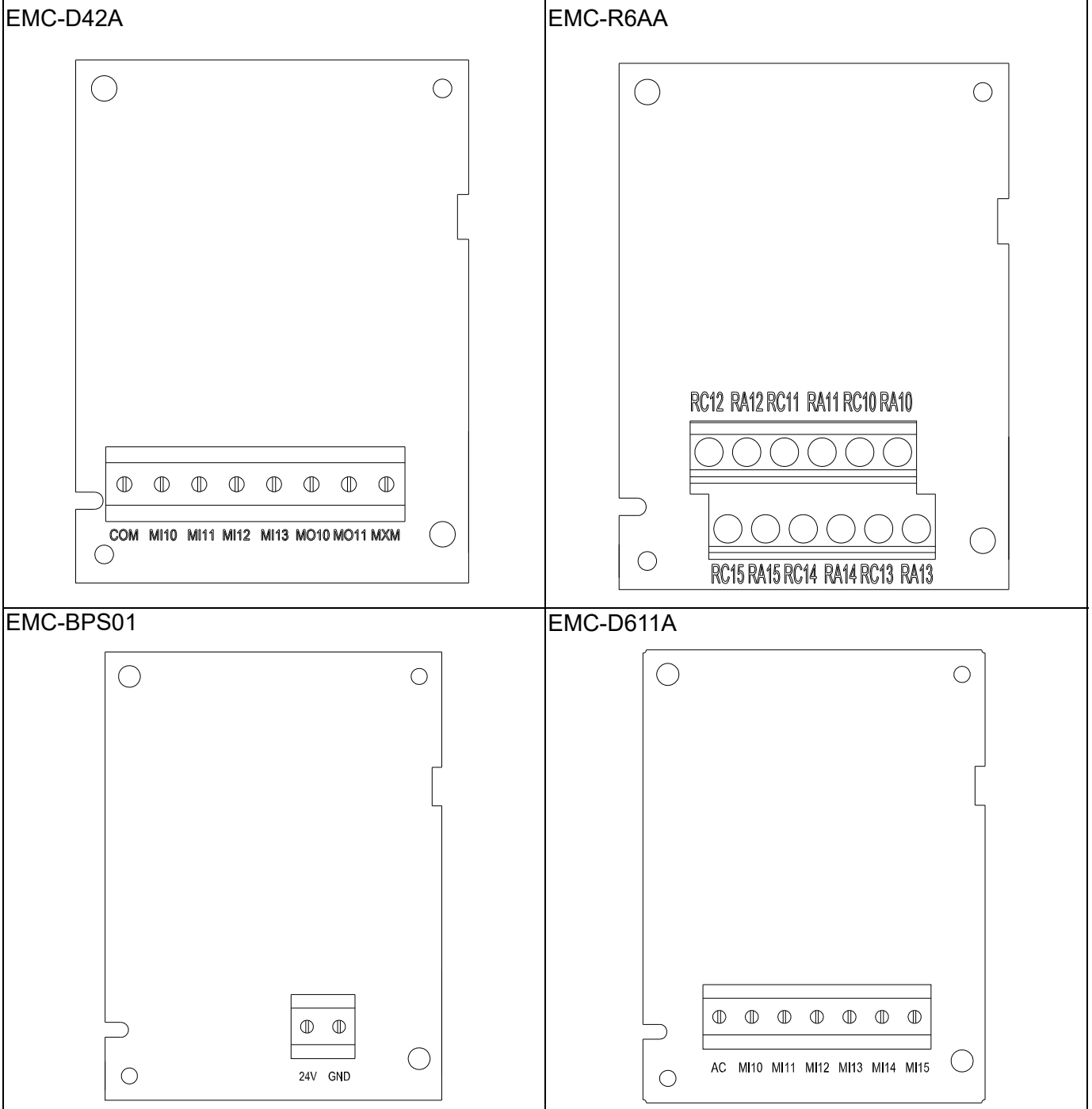

Communication extension card (Slot 1)

CMC-PD01

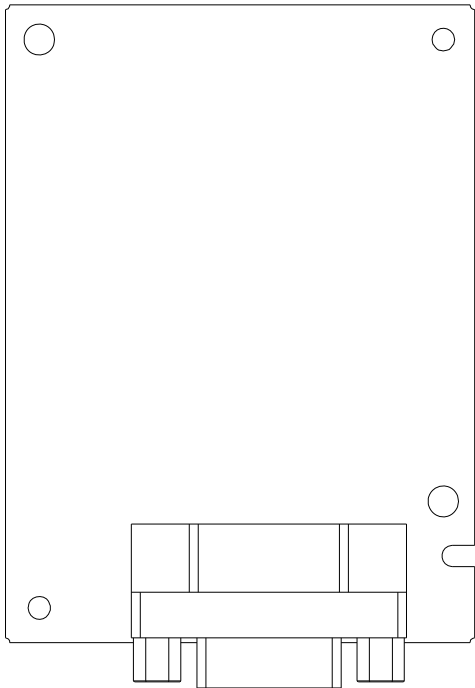

CMC-DN01

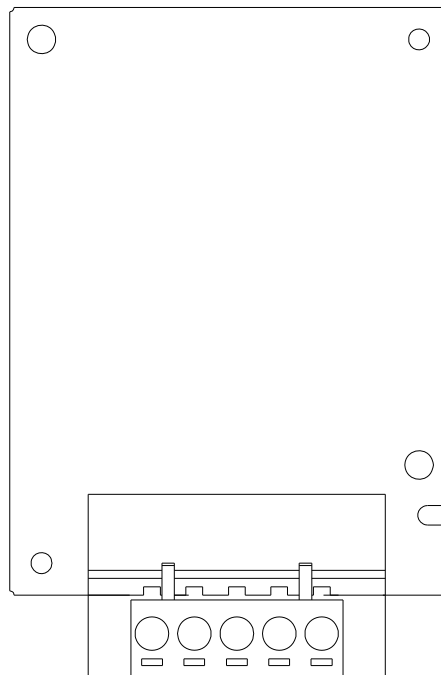

CMC-MOD01/ CMC-EIP01

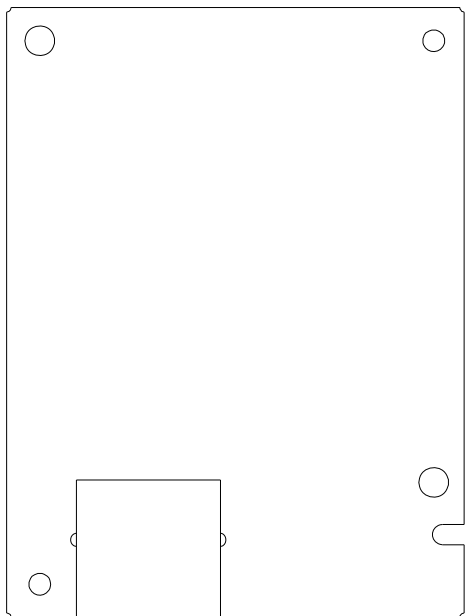

EMC-COP01

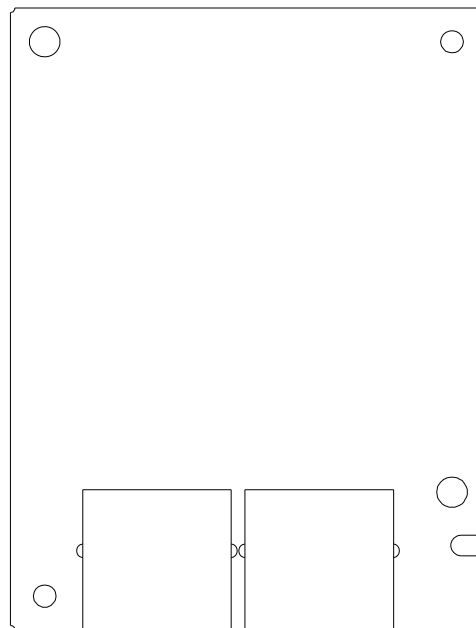

8-1-3 Install and Uninstall of Extension Cards (i.e. communication card installation)

8-1-3-1 Installation

Extension Card Installation

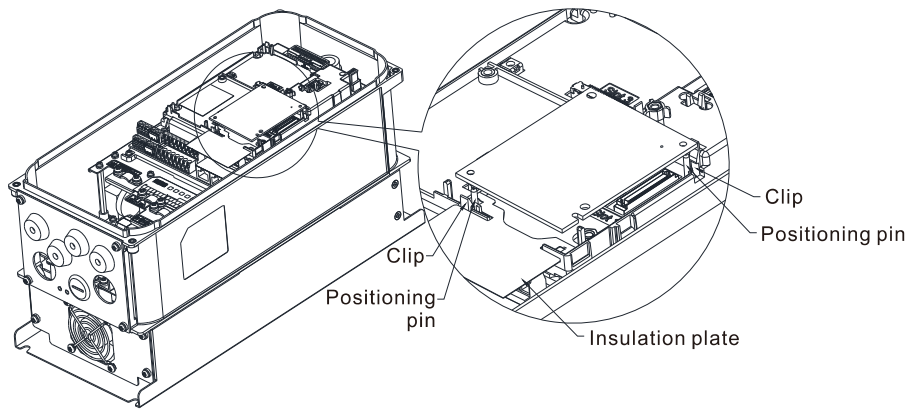

Put the insulating plate on the positioning pin first, then align the positioning pin by using two holes on the PCB, press it and let two clips stuck on the PCB as the figure showing.

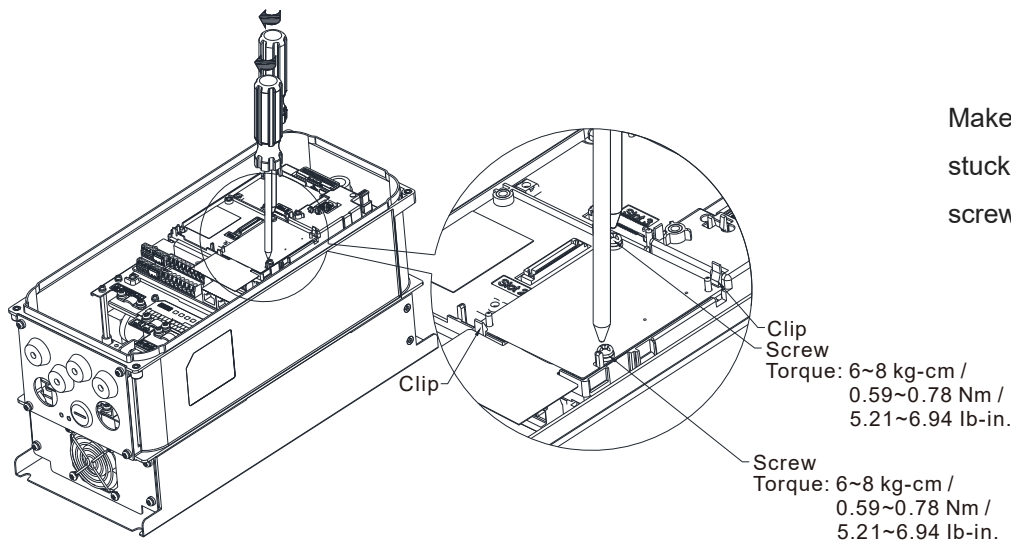

Make sure that the two clips are stuck on the PCB then lock the screws as the figure showing.

Clip Screw Torque: 6~8 kg-cm / 0.59~0.78 Nm / 5.21~6.94 lb-in.
Screw Torque: 6~8 kg-cm / 0.59~0.78 Nm / 5.21~6.94 lb-in.

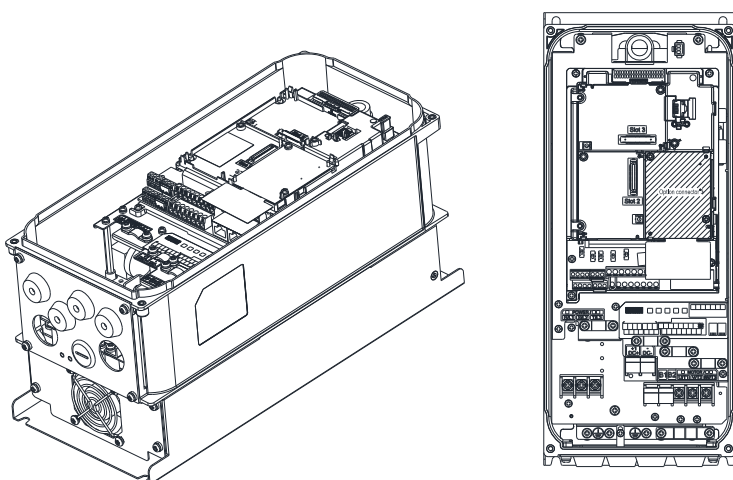

The assembly is completed as the figure showing.

8-1-3-2 Disconnecting the extension card

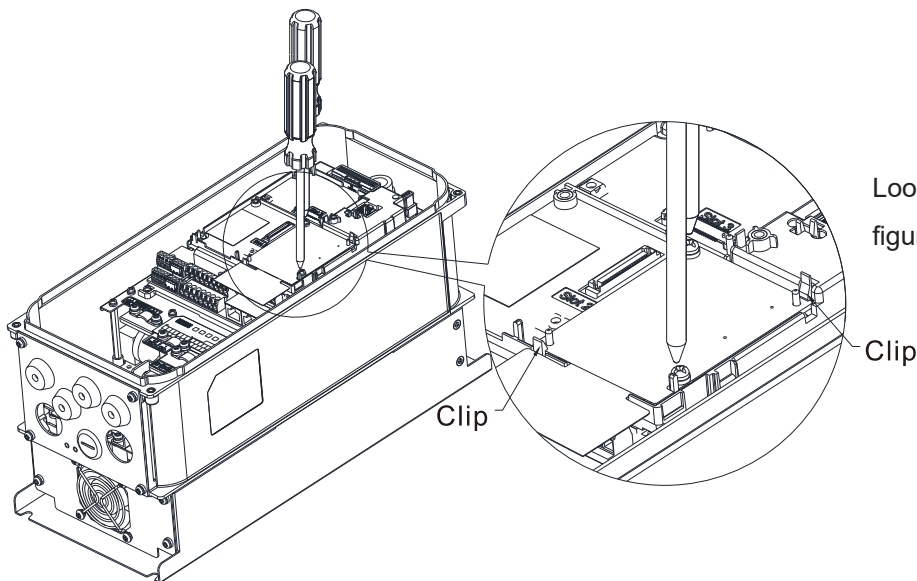

Loosen the two screws as the figure showing.

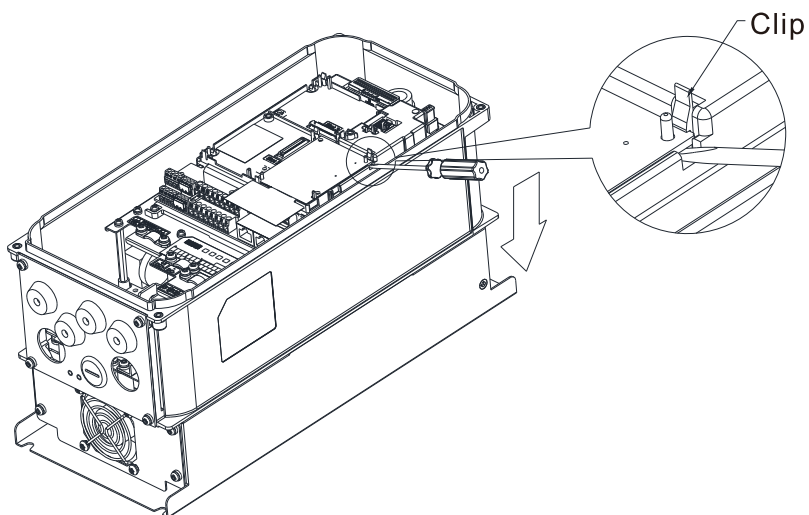

Pull open the clip then put slotted screwdriver into the sag under the PCB, let PCB out of the clip as the figure showing.

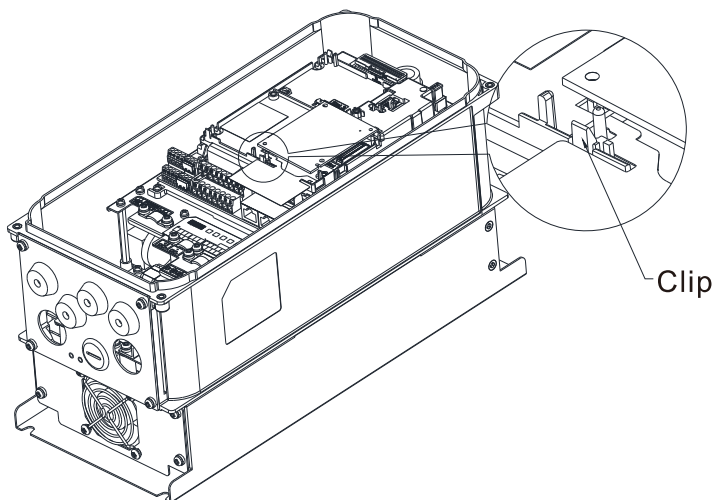

Twist to open the other card clip to remove the PCB.

8-2 EMC-D42A

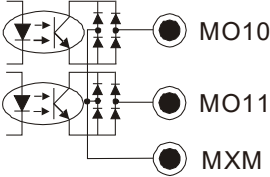
	Terminals	Descriptions
I/O Extension Card	COM	Common for Multi-function input terminals Select SINK (NPN) /SOURCE (PNP) in J1 jumper / external power supply
	MI10~ MI13	Refer to parameters 02-26~02-29 to program the multi-function inputs MI10~MI13. Internal power is applied from terminal E24: +24VDC±5% 200mA, 5W External power +24VDC: max. voltage 30VDC, min. voltage 19VDC ON: the activation current is 6.5mA OFF: leakage current tolerance is 10µA
	MO10~MO11	Multi-function output terminals (photocoupler) The AC motor drive releases various monitor signals, such as drive in operation, frequency attained and overload indication, via transistor (open collector). 
	MXM	Common for multi-function output terminals MO10, MO11(photocoupler) Max 48VDC 50mA

8-3 EMC-D611A

	Terminals	Descriptions
I/O Extension Card	AC	AC power Common for multi-function input terminal (Neutral)
	MI10~ MI15	Refer to Pr. 02-26~ Pr. 02-31 for multi-function input selection Input voltage: 100~130VAC Input frequency: 47~63Hz Input impedance: 27Kohm Terminal response time: ON: 10ms OFF: 20ms

8-4 EMC-R6AA

	Terminals	Descriptions
Relay Extension Card	RA10~RA15 RC10~RC15	Refer to Pr. 02-36~ Pr. 02-41 for multi-function input selection Resistive load: 5A(N.O.) 250VAC 5A(N.O.) 30VDC Inductive load (COS 0.4) 2.0A(N.O.) 250VAC 2.0A(N.O.) 30VDC It is used to output each monitor signal, such as drive is in operation, frequency attained or overload indication.

8-5 EMC-BPS01

	Terminals	Descriptions
External Power Supply		Input power: 24V±5% Maximum input current: 0.5A Note: 1) Do not connect control terminal +24V (Digital control signal common: SOURCE) directly to the EMC-BPS01 input terminal 24V. 2) Do not connect control terminal GND directly to the EMC-BPS01 input terminal GND.
	24V GND	Function: When the motor drive is powered by the EMC-BPS01, all the communications are open. All the communication cards and functions below are supported. <ol style="list-style-type: none"> 1. Read and write parameters. 2. Warning messages can be displayed on the keypad. 3. Every button on the keypad is operational except the RUN button. 4. Analog inputs are effective 5. Keep the communication open. 6. Multi-function input terminals needs external power to work. The following functions are NOT supported. Relay out (including extension card), PG card and PLC function.

8-6 CMC-MOD01

8-6-1 Features

1. Supports Modbus TCP protocol
2. MDI/MDI-X auto-detect
3. Baud rate: 10/100Mbps auto-detect
4. E-mail alarm
5. AC motor drive keypad/Ethernet configuration
6. Virtual serial port.

8-6-2 Product File

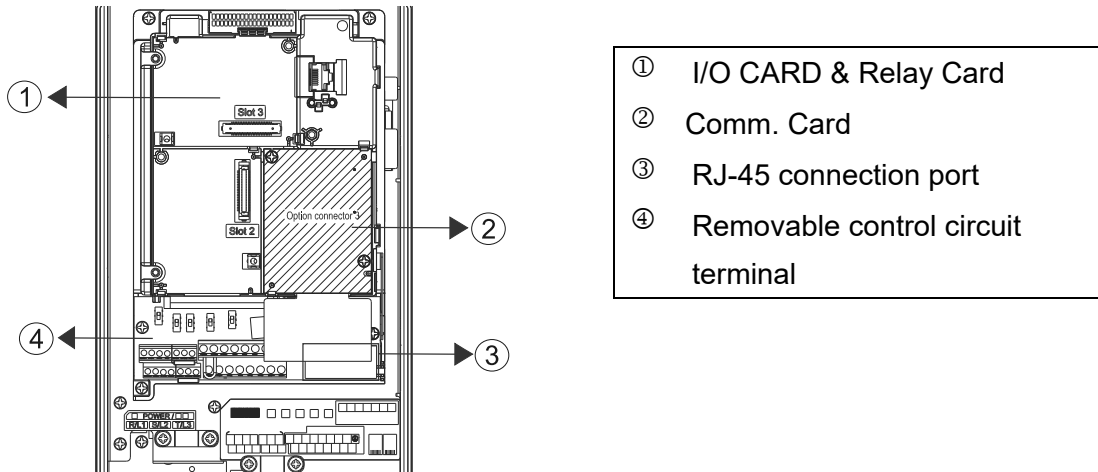

8-6-3 Specifications

Network Interface

Interface	RJ-45 with Auto MDI/MDIX
Number of ports	1 Port
Transmission method	IEEE 802.3, IEEE 802.3u
Transmission cable	Category 5e shielding 100M
Transmission speed	10/100 Mbps Auto-Detect
Network protocol	ICMP, IP, TCP, UDP, DHCP, SMTP, MODBUS OVER TCP/IP, Delta Configuration

Electrical Specification

Power supply voltage	5VDC (supply by the AC motor drive)
Insulation voltage	500VDC
Power consumption	0.8W
Weight	25g

Environment

Noise immunity	ESD (IEC 61800-5-1, IEC 61000-4-2) EFT (IEC 61800-5-1, IEC 61000-4-4) Surge Test (IEC 61800-5-1, IEC 61000-4-5) Conducted Susceptibility Test (IEC 61800-5-1, IEC 61000-4-6)
Operation/storage	Operation: -10°C ~ 50°C (temperature), 90% (humidity) Storage: -25°C ~ 70°C (temperature), 95% (humidity)
Vibration/shock immunity	International standard: IEC 61800-5-1, IEC 60068-2-6/IEC 61800-5-1, IEC 60068-2-27

8-6-4 Communication Parameters for VFD-CFP2000 Connected to Ethernet

When VFD-CFP2000 is linking to Ethernet, please set up the communication parameters based on the table below. Ethernet master will be able to read/write the frequency word and control word of VFD-CFP2000 after communication parameters setup.

Parameter	Function	Set value (Dec)	Explanation
P00-20	Source of frequency command setting	8	The frequency command is controlled by communication card.
P00-21	Source of operation command setting	5	The operation command is controlled by communication card.
P09-30	Decoding method for communication	0	Decoding method for Delta AC motor drive
P09-75	IP setting	0	Static IP(0) / Dynamic distribution IP(1)
P09-76	IP address -1	192	IP address 192.168.1.5
P09-77	IP address -2	168	IP address 192.168.1.5
P09-78	IP address -3	1	IP address 192.168.1.5
P09-79	IP address -4	5	IP address 192.168.1.5
P09-80	Netmask -1	255	Netmask 255.255.255.0
P09-81	Netmask -2	255	Netmask 255.255.255.0
P09-82	Netmask -3	255	Netmask 255.255.255.0
P09-83	Netmask -4	0	Netmask 255.255.255.0
P09-84	Default gateway -1	192	Default gateway 192.168.1.1
P09-85	Default gateway -2	168	Default gateway 192.168.1.1
P09-86	Default gateway -3	1	Default gateway 192.168.1.1
P09-87	Default gateway -4	1	Default gateway 192.168.1.1

8-6-5 Basic Registers

BR#	R/W	Content	Explanation
#0	R	Model name	Set up by the system; read only. The model code of CMC-MOD01=H'0203
#1	R	Firmware version	Displaying the current firmware version in hex, e.g. H'0100 indicates the firmware version V1.00.
#2	R	Release date of the version	Displaying the data in decimal form. 10,000s digit and 1,000s digit are for "month"; 100s digit and 10s digit are for "day". For 1 digit: 0 = morning; 1 = afternoon.
#11	R/W	Modbus Timeout	Default setting: 500 (ms)
#13	R/W	Keep Alive Time	Default setting: 30 (s)

8-6-6 LED Indicator & Troubleshooting

LED Indicators

LED	Status	Indication	How to correct it?	
POWER	Green	On	Power supply in normal status	--
		Off	No power supply	Check the power supply
LINK	Green	On	Network connection in normal status	--
		Flashes	Network in operation	--
		Off	Network not connected	Check if the network cable is connected

Troubleshooting

Abnormality	Cause	How to correct it?
POWER LED off	AC motor drive not powered	Check if AC motor drive is powered, and if the power supply is normal.
	CMC-MOD01 not connected to AC motor drive	Make sure CMC-MOD01 is connected to AC motor drive.
LINK LED off	CMC-MOD01 not connected to network	Make sure the network cable is correctly connected to network.
	Poor contact to RJ-45 connector	Make sure RJ-45 connector is connected to Ethernet port.
No module found	CMC-MOD01 not connected to network	Make sure CMC-MOD01 is connected to network.
	PC and CMC-MOD01 in different networks and blocked by network firewall.	Search by IP or set up relevant settings by AC motor drive keypad.
Fail to open CMC-MOD01 setup page	CMC-MOD01 not connected to network	Make sure CMC-MOD01 is connected to the network.
	Incorrect communication setting in DCISoft	Make sure the communication setting in DCISoft is set to Ethernet.
	PC and CMC-MOD01 in different networks and blocked by network firewall.	Conduct the setup by AC motor drive keypad.
Able to open CMC-MOD01 setup page but fail to utilize webpage monitoring	Incorrect network setting in CMC-MOD01	Check if the network setting for CMC-MOD01 is correct. For the Intranet setting in your company, please consult your IT staff. For the Internet setting in your home, please refer to the network setting instruction provided by your ISP.
Fail to send e-mail	Incorrect network setting in CMC-MOD01	Check if the network setting for CMC-MOD01 is correct.
	Incorrect mail server setting	Please confirm the IP address for SMTP-Server.

8-7 CMC-PD01

8-7-1 Features

1. Supports PZD control data exchange.
2. Supports PKW polling AC motor drive parameters.
3. Supports user diagnosis function.
4. Auto-detects baud rates; supports Max. 12Mbps.

8-7-2 Product Profile

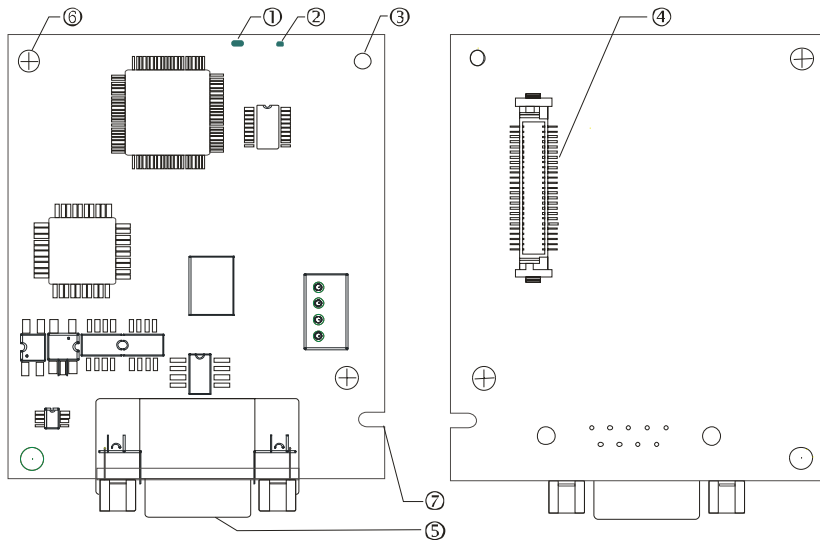

- | |
|-----------------------------------|
| 1. NET indicator |
| 2. POWER indicator |
| 3. Positioning hole |
| 4. AC motor drive connection port |
| 5. PROFIBUS DP connection port |
| 6. Screw fixing hole |
| 7. Fool-proof groove |

8-7-3 Specifications

PROFIBUS DP Connector

Interface	DB9 connector
Transmission method	High-speed RS-485
Transmission cable	Shielded twisted pair cable
Electrical isolation	500VDC

Communication

Message type	Cyclic data exchange
Module name	CMC-PD01
GSD document	DELA08DB.GSD
Company ID	08DB (HEX)
Serial transmission speed supported (auto-detection)	9.6Kbps, 19.2Kbps, 93.75Kbps, 187.5Kbps, 500Kbps, 1.5Mbps, 3Mbps, 6Mbps, 12Mbps (bit per second)

Electrical Specification

Power supply	5VDC (supplied by AC motor drive)
Insulation voltage	500VDC
Power consumption	1W
Weight	28g

Environment

Noise immunity	ESD (IEC 61800-5-1, IEC 61000-4-2) EFT (IEC 61800-5-1, IEC 61000-4-4) Surge Teat (IEC 61800-5-1, IEC 61000-4-5) Conducted Susceptibility Test (IEC 61800-5-1, IEC 61000-4-6)
Operation /storage	Operation: -10°C ~ 50°C (temperature), 90% (humidity) Storage: -25°C ~ 70°C (temperature), 95% (humidity)
Shock / vibration resistance	International standards: IEC 61800-5-1, IEC 60068-2-6 / IEC 61800-5-1 & IEC 60068-2-27

8-7-4 Installation

PROFIBUS DP Connector

PIN	PIN name	Definition
1	-	Not defined
2	-	Not defined
3	Rxd/Txd-P	Sending/receiving data P(B)
4	-	Not defined
5	DGND	Data reference ground
6	VP	Power voltage – positive
7	-	Not defined
8	Rxd/Txd-N	Sending/receiving data N(A)
9	-	Not defined

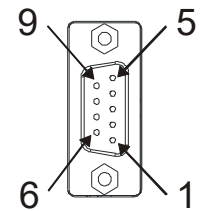

8-7-5 LED Indicator & Troubleshooting

There are 2 LED indicators on CMC-PD01. POWER LED displays the status of the working power. NET LED displays the connection status of the communication.

POWER LED

LED status	Indication	How to correct it?
Green light on	Power supply in normal status.	--
Off	No power	Check if the connection between CMC-PD01 and AC motor drive is normal.

NET LED

LED status	Indication	How to correct it?
Green light on	Normal status	--
Red light on	CMC-PD01 is not connected to PROFIBUS DP bus.	Connect CMC-PD01 to PROFIBUS DP bus.
Red light flashes	Invalid PROFIBUS communication address	Set the PROFIBUS address of CMC-PD01 between 1 ~ 125 (decimal)
Orange light flashes	CMC-PD01 fails to communicate with AC motor drive.	Switch off the power and check whether CMC-PD01 is correctly and normally connected to AC motor drive.

8-8 CMC-DN01

8-8-1 Functions

1. Based on the high-speed communication interface of Delta HSSP protocol, able to conduct immediate control to AC motor drive.
2. Supports Group 2 only connection and polling I/O data exchange.
3. For I/O mapping, supports Max. 32 words of input and 32 words of output.
4. Supports EDS file configuration in DeviceNet configuration software.
5. Supports all baud rates on DeviceNet bus: 125Kbps, 250Kbps, 500Kbps and extendable serial transmission speed mode.
6. Node address and serial transmission speed can be set up on AC motor drive.
7. Power supplied from AC motor drive.

8-8-2 Product Profile

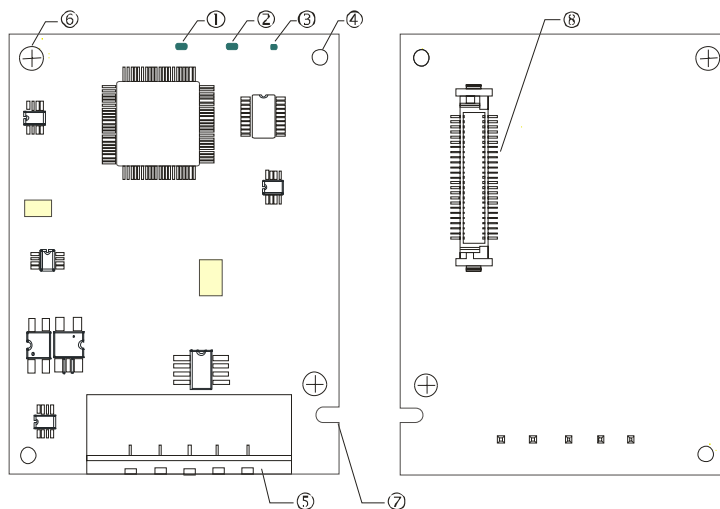

1. NS indicator
2. MS indicator
3. POWER indicator
4. Positioning hole
5. DeviceNet connection port
6. Screw fixing hole
7. Fool-proof groove
8. AC motor drive connection port

8-8-3 Specifications

DeviceNet Connector

Interface	5-PIN open removable connector. Of 5.08mm PIN interval
Transmission	CAN
Transmission cable	Shielded twisted pair cable (with 2 power cables)
Transmission speed	125Kbps, 250Kbps, 500Kbps and extendable serial transmission speed
Network protocol	DeviceNet protocol

AC Motor Drive Connection Port

Interface	50 PIN communication terminal
Transmission method	SPI communication
Terminal function	1. Communicating with AC motor drive 2. Transmitting power supply from AC motor drive
Communication	Delta HSSP protocol

Electrical Specification

Power supply voltage	5VDC (supplied by AC motor drive)
Insulation voltage	500VDC
Communication wire power consumption	0.85W
Power consumption	1W
Weight	23g

Environment

Noise immunity	ESD (IEC 61800-5-1, IEC 61000-4-2) EFT (IEC 61800-5-1, IEC 61000-4-4) Surge Teat (IEC 61800-5-1, IEC 61000-4-5) Conducted Susceptibility Test (IEC 61800-5-1, IEC 61000-4-6)
Operation /storage	Operation: -10°C ~ 50°C (temperature), 90% (humidity) Storage: -25°C ~ 70°C (temperature), 95% (humidity)
Shock / vibration resistance	International standards: IEC 61800-5-1, IEC 60068-2-6 / IEC 61800-5-1 & IEC 60068-2-27

DeviceNet Connector

PIN	Signal	Color	Definition
1	V+	Red	DC24V
2	H	White	Signal+
3	S	-	Earth
4	L	Blue	Signal-
5	V-	Black	0V

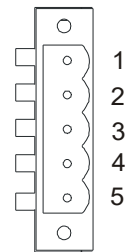

8-8-4 LED Indicator & Troubleshooting

There are 3 LED indicators on CMC-DN01. POWER LED displays the status of power supply. MS LED and NS LED are dual-color LED, displaying the connection status of the communication and error messages.

POWER LED

LED status	Indication	How to correct it?
On	Power supply in abnormal status.	Check the power supply of CMC-DN01.
Off	Power supply in normal status	--

NS LED

LED status	Indication	How to correct it?
Off	No power supply or CMC-DN01 has not completed MAC ID test yet.	<ol style="list-style-type: none"> 1. Check the power of CMC-DN01 and see if the connection is normal. 2. Make sure at least one or more nodes are on the bus. 3. Check if the serial transmission speed of CMC-DN01 is the same as that of other nodes.
Green light flashes	CMC-DN01 is on-line but has not established connection to the master.	<ol style="list-style-type: none"> 1. Configure CMC-DN01 to the scan list of the master. 2. Re-download the configured data to the master.
Green light on	CMC-DN01 is on-line and is normally connected to the master	--
Red light flashes	CMC-DN01 is on-line, but I/O connection is timed-out.	<ol style="list-style-type: none"> 1. Check if the network connection is normal. 2. Check if the master operates normally.
Red light on	<ol style="list-style-type: none"> 1. The communication is down. 2. MAC ID test failure. 3. No network power supply. 4. CMC-DN01 is off-line. 	<ol style="list-style-type: none"> 1. Make sure all the MAC IDs on the network are not repeated. 2. Check if the network installation is normal. 3. Check if the baud rate of CMC-DN01 is consistent with that of other nodes. 4. Check if the node address of CMC-DN01 is illegal. 5. Check if the network power supply is normal.

MS LED

LED status	Indication	How to correct it?
Off	No power supply or being off-line	Check the power supply of CMC-DN01 and see if the connection is normal.
Green light flashes	Waiting for I/O data	Switch the master PLC to RUN status
Green light on	I/O data are normal	--
Red light flashes	Mapping error	<ol style="list-style-type: none"> 1. Reconfigure CMC-DN01 2. Re-power AC motor drive
Red light on	Hardware error	<ol style="list-style-type: none"> 1. See the error code displayed on AC motor drive. 2. Send back to the factory for repair if necessary.
Orange light flashes	CMC-DN01 is establishing connection with AC motor drive.	If the flashing lasts for a long time, check if CMC-DN01 and AC motor drive are correctly installed and normally connected to each other.

8-9 CMC-EIP01

8-9-1 Features

1. Supports Modbus TCP and Ethernet/IP protocol
2. MDI/MDI-X auto-detect
3. Baud rate: 10/100Mbps auto-detect
4. AC motor drive keypad/Ethernet configuration
5. Virtual serial port

8-9-2 Product Profile

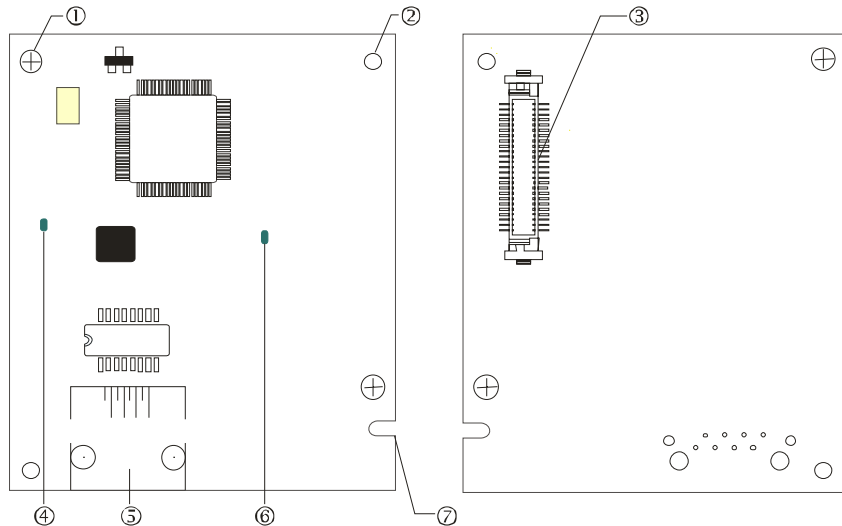

[Figure1]

1. Screw fixing hole
2. Positioning hole
3. AC motor drive connection port
4. LINK indicator
5. RJ-45 connection port
6. POWER indicator
7. Fool-proof groove

8-9-3 Specifications

Network Interface

Interface	RJ-45 with Auto MDI/MDIX
Number of ports	1 Port
Transmission method	IEEE 802.3, IEEE 802.3u
Transmission cable	Category 5e shielding 100M
Transmission speed	10/100 Mbps Auto-Detect
Network protocol	ICMP, IP, TCP, UDP, DHCP, HTTP, SMTP, MODBUS OVER TCP/IP, EtherNet/IP, Delta Configuration

Electrical Specification

Weight	25g
Insulation voltage	500VDC
Power consumption	0.8W
Power supply voltage	5VDC

Environment

Noise immunity	ESD (IEC 61800-5-1, IEC 61000-4-2) EFT (IEC 61800-5-1, IEC 61000-4-4) Surge Test (IEC 61800-5-1, IEC 61000-4-5) Conducted Susceptibility Test (IEC 61800-5-1, IEC 61000-4-6)
Operation/storage	Operation: -10°C ~ 50°C (temperature), 90% (humidity) Storage: -25°C ~ 70°C (temperature), 95% (humidity)
Vibration/shock immunity	International standard: IEC 61800-5-1, IEC 60068-2-6/IEC 61800-5-1, IEC 60068-2-27

8-9-4 Installation

Connecting CMC-EIP01 to Network

1. Turn off the power of AC motor drive.
2. Open the cover of AC motor drive.
3. Connect CAT-5e network cable to RJ-45 port on CMC-EIP01 (See Figure 2).

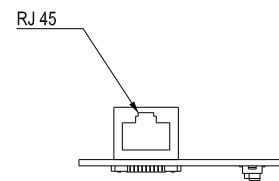

[Figure 2]

RJ-45 PIN Definition

PIN	Signal	Definition	PIN	Signal	Definition
1	Tx+	Positive pole for data transmission	5	--	N/C
2	Tx-	Negative pole for data transmission	6	Rx-	Negative pole for data receiving
3	Rx+	Positive pole for data receiving	7	--	N/C
4	--	N/C	8	--	N/C

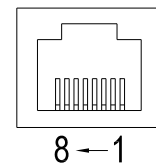

8-9-5 Communication Parameters for VFD-CFP2000 Connected to Ethernet

When VFD-CFP2000 is connected to Ethernet network, please set up the communication parameters for it according to the table below. The Ethernet master is only able to read/write the frequency word and control word of VFD-CFP2000 after the communication parameters are set.

Parameter	Function	Set value (Dec)	Explanation
P00-20	Source of frequency command setting	8	The frequency command is controlled by communication card.
P00-21	Source of operation command setting	5	The operation command is controlled by communication card.
P09-30	Decoding method for communication	0	The decoding method for Delta AC motor drive
P09-75	IP setting	0	Static IP(0) / Dynamic distribution IP(1)
P09-76	IP address -1	192	IP address 192.168.1.5
P09-77	IP address -2	168	IP address 192.168.1.5
P09-78	IP address -3	1	IP address 192.168.1.5
P09-79	IP address -4	5	IP address 192.168.1.5

Parameter	Function	Set value (Dec)	Explanation
P09-80	Netmask -1	255	Netmask 255.255.255.0
P09-81	Netmask -2	255	Netmask 255.255.255.0
P09-82	Netmask -3	255	Netmask 255.255.255.0
P09-83	Netmask -4	0	Netmask 255.255.255.0
P09-84	Default gateway -1	192	Default gateway 192.168.1.1
P09-85	Default gateway -2	168	Default gateway 192.168.1.1
P09-86	Default gateway -3	1	Default gateway 192.168.1.1
P09-87	Default gateway -4	1	Default gateway 192.168.1.1

8-9-6 LED Indicator & Troubleshooting

There are 2 LED indicators on CMC-EIP01. The POWER LED displays the status of power supply, and the LINK LED displays the connection status of the communication.

LED Indicators

LED	Status	Indication	How to correct it?	
POWER	Green	On	Power supply in normal status	--
		Off	No power supply	Check the power supply.
LINK	Green	On	Network connection in normal status	--
		Flashes	Network in operation	--
		Off	Network not connected	Check if the network cable is connected.

Troubleshooting

Abnormality	Cause	How to correct it?
POWER LED off	AC motor drive not powered	Check if AC motor drive is powered, and if the power supply is normal.
	CMC-EIP01 not connected to AC motor drive	Make sure CMC-EIP01 is connected to AC motor drive.
LINK LED off	CMC-EIP01 not connected to network	Make sure the network cable is correctly connected to network.
	Poor contact to RJ-45 connector	Make sure RJ-45 connector is connected to Ethernet port.
No communication card found	CMC-EIP01 not connected to network	Make sure CMC-EIP01 is connected to network.
	PC and CMC-EIP01 in different networks and blocked by network firewall.	Search by IP or set up relevant settings by AC motor drive keypad.
Fail to open CMC-EIP01 setup page	CMC-EIP01 not connected to network	Make sure CMC-EIP01 is connected to the network.
	Incorrect communication setting in DCISoft	Make sure the communication setting in DCISoft is set to Ethernet.
	PC and CMC-EIP01 in different networks and blocked by network firewall.	Conduct the setup by AC motor drive keypad.

Abnormality	Cause	How to correct it?
Able to open CMC-EIP01 setup page but fail to utilize webpage monitoring	Incorrect network setting in CMC-EIP01	Check if the network setting for CMC-EIP01 is correct. For the Intranet setting in your company, please consult your IT staff. For the Internet setting in your home, please refer to the network setting instruction provided by your ISP.
Fail to send e-mail	Incorrect network setting in CMC-EIP01	Check if the network setting for CMC-EIP01 is correct.
	Incorrect mail server setting	Please confirm the IP address for SMTP-Server.

8-10 EMC-COP01

8-10-1 Position of terminal resistance

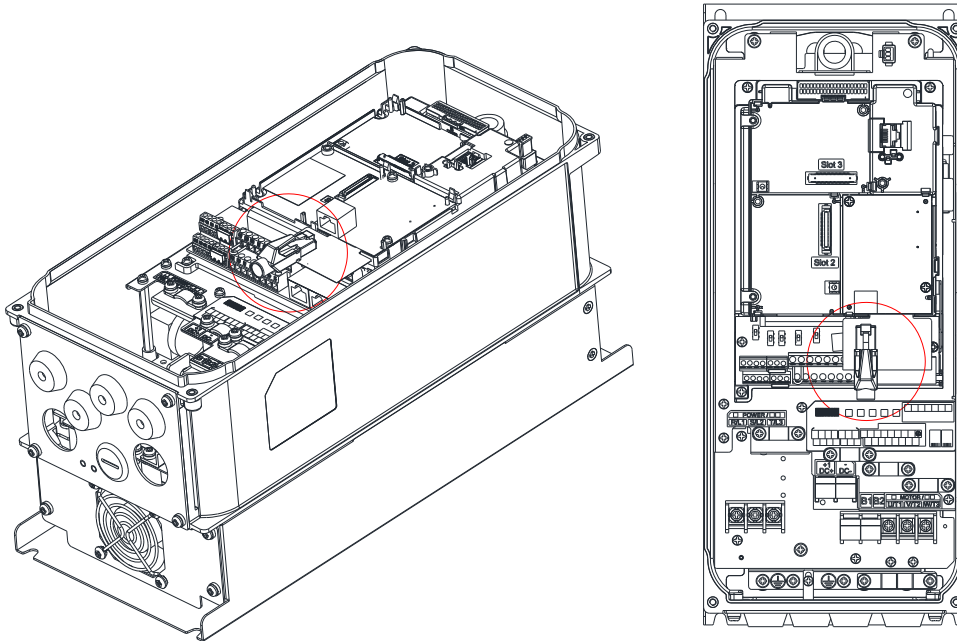

8-10-2 RJ-45 Pin definition



Pin	Pin name	Definition
1	CAN_H	CAN_H bus line (dominant high)
2	CAN_L	CAN_L bus line (dominant low)
3	CAN_GND	Ground/0V/V-
7	CAN_GND	Ground/0V/V-

8-10-3 Specifications

Interface	RJ-45
Number of ports	1 Port
Transmission method	CAN
Transmission cable	CAN standard cable
Transmission speed	1Mbps, 500Kbps, 250Kbps, 125Kbps, 100Kbps, 50Kbps
Communication protocol	CANopen

8-11 Delta Standard Fieldbus Cables

Delta Cables	Part Number	Description	Length
CANopen Cable	UC-CMC003-01A	CANopen Cable, RJ45 Connector	0.3m
	UC-CMC005-01A	CANopen Cable, RJ45 Connector	0.5m
	UC-CMC010-01A	CANopen Cable, RJ45 Connector	1m
	UC-CMC015-01A	CANopen Cable, RJ45 Connector	1.5m
	UC-CMC020-01A	CANopen Cable, RJ45 Connector	2m
	UC-CMC030-01A	CANopen Cable, RJ45 Connector	3m
	UC-CMC050-01A	CANopen Cable, RJ45 Connector	5m
	UC-CMC100-01A	CANopen Cable, RJ45 Connector	10m
	UC-CMC200-01A	CANopen Cable, RJ45 Connector	20m
DeviceNet Cable	UC-DN01Z-01A	DeviceNet Cable	305m
	UC-DN01Z-02A	DeviceNet Cable	305m
Ethernet / EtherCAT Cable	UC-EMC003-02A	Ethernet/EtherCAT cable, Shielding	0.3m
	UC-EMC005-02A	Ethernet/EtherCAT cable, Shielding	0.5m
	UC-EMC010-02A	Ethernet/EtherCAT cable, Shielding	1m
	UC-EMC020-02A	Ethernet/EtherCAT cable, Shielding	2m
	UC-EMC050-02A	Ethernet/EtherCAT cable, Shielding	5m
	UC-EMC100-02A	Ethernet/EtherCAT cable, Shielding	10m
	UC-EMC200-02A	Ethernet/EtherCAT cable, Shielding	20m
CANopen / DeviceNet TAP	TAP-CN01	1 in 2 out, built-in 121Ω terminal resistor	1 in 2 out
	TAP-CN02	1 in 4 out, built-in 121Ω terminal resistor	1 in 4 out
	TAP-CN03	1 in 4 out, RJ45 connector, built-in 121Ω terminal resistor	1 in 4 out
PROFIBUS Cable	UC-PF01Z-01A	PROFIBUS DP Cable	305m

[This page intentionally left blank]

Chapter 9 Specification

9-1 460V Series

9-2 Environment for Operation, Storage and
Transportation

9-3 Specifications for Operation Temperature and
Protection Level

9-4 Derating of Ambient Temperature and Altitude

9-1 460V Series

Frame Size		A							B				
Model VFD FP4EA-		007	015	022	037	040	055	075	110	150	185	220	
Output Rating	Light duty	Rated output capacity [kVA]	2.4	3.3	4.4	6.8	8.4	10.4	14.3	19	25	30	36
		Rated output current [A]	3.0	4.2	5.5	8.5	10.5	13	18	24	32	38	45
		Applicable motor output [kW]	0.75	1.5	2.2	3.7	4	5.5	7.5	11	15	18.5	22
		Applicable motor output [HP]	1	2	3	5	5	7.5	10	15	20	25	30
		Overload tolerance	120% of rated current can endure for 1 minute during every 5 minutes										
	Normal duty	Max. output frequency [Hz]	599Hz										
		Carrier frequency [kHz]	2~15 (6kHz)										2~10 (6kHz)
		Rated output capacity [kVA]	1.4	2.4	3.2	4.8	7.2	8.4	9.6	14.3	19	25	30
		Rated output current [A]	1.7	3.0	4.0	6.0	9.0	10.5	12	18	24	32	38
		Applicable motor output [kW]	0.4	0.75	1.5	2.2	3.7	4	5.5	7.5	11	15	18.5
Input Rating	Applicable motor output [HP]	0.5	1	2	3	5	5	7.5	10	15	20	25	
	Overload tolerance	120% of rated current can endure for 1 minute during every 5 minutes 160% of rated current can endure for 3 seconds during every 30 seconds.											
	Max. output frequency [Hz]	599Hz											
Input Rating	Carrier frequency [kHz]	2~15 (6kHz)										2~10 (6kHz)	
	Input current [A] Light duty	3.0	4.2	5.5	8.5	10.5	13	18	24	32	38	45	
	Input current [A] Normal duty	1.7	3	4	6	9.0	10.5	12	18	24	32	38	
	Rated voltage / Frequency	3-phase AC 380V~480V [-15%~+10%], 50/60Hz											
Input Rating	Operating voltage range	323~528VAC											
	Frequency tolerance	47~63Hz											
	Efficiency [%]	97											
	Power factor	>0.98											
	Weight	6.8kg							14.5kg				
	Cooling method	Natural cooling			Fan cooling								
Braking chopper	Frame A to C (built-in)												
DC choke	Built-in DC reactor EN61000-3-12												
EMC Filter	Built-in EMC Filter EN61800-3 C1 & C2												

NOTE

- The value of the carrier frequency is a factory setting. To increase the carrier frequency, the current needs to be decreased. Please see derating curve diagram of Pr. 06-55 for more information.
- When a load is a surge load, use a higher level model.

460V Series

Frame Size		C		D0		D		
Model VFD FP4EA-		300	370	450	550	750	900	
Output Rating	Light duty	Rated output capacity [kVA]	48	58	73	88	120	143
		Rated output current [A]	60	73	91	110	150	180
		Applicable motor output [kW]	30	37	45	55	75	90
		Applicable motor output [HP]	40	50	60	75	100	125
		Overload tolerance	120% of rated current can endure for 1 minute during every 5 minutes					
	Normal duty	Max. output frequency [Hz]	599Hz					
		Carrier frequency [kHz]	2~10kHz (6kHz)					2~9kHz (4kHz)
		Rated output capacity [kVA]	36	48	58	73	88	120
		Rated output current [A]	45	60	73	91	110	150
		Applicable motor output [kW]	22	30	37	45	55	75
Input Rating	Applicable motor output [HP]	30	40	50	60	75	100	
	Overload tolerance	120% of rated current can endure for 1 minute during every 5 minutes 160% of rated current can endure for 3 seconds during every 30 seconds.						
	Max. output frequency [Hz]	599Hz						
Input Rating	Carrier frequency [kHz]	2~10kHz (6kHz)					2~9kHz (4kHz)	
	Input current [A] Light duty	60	73	91	110	150	180	
	Input current [A] Normal duty	45	60	73	91	110	150	
	Rated voltage / Frequency	3-phase AC 380V~480V (-15% ~ +10%), 50/60Hz						
	Operating voltage range	323~528VAC						
	Frequency tolerance	47~63Hz						
Input Rating	Efficiency [%]	97						
	Power factor	>0.98						
	Weight	26.5kg		42kg		59.5kg		
	Cooling method	Fan cooling						
	Braking chopper	Frame A to C (built-in)						
	DC choke	Built-in DC reactor EN61000-3-12						
EMC Filter	Built-in EMC Filter EN61800-3 C1 & C2							

NOTE

- The value of the carrier frequency is a factory setting. To increase the carrier frequency, the current needs to be decreased. See derating curve diagram of Pr06-55 for more information.
- When a load is a shock or impact load, use a higher level model.

Efficiency Curve

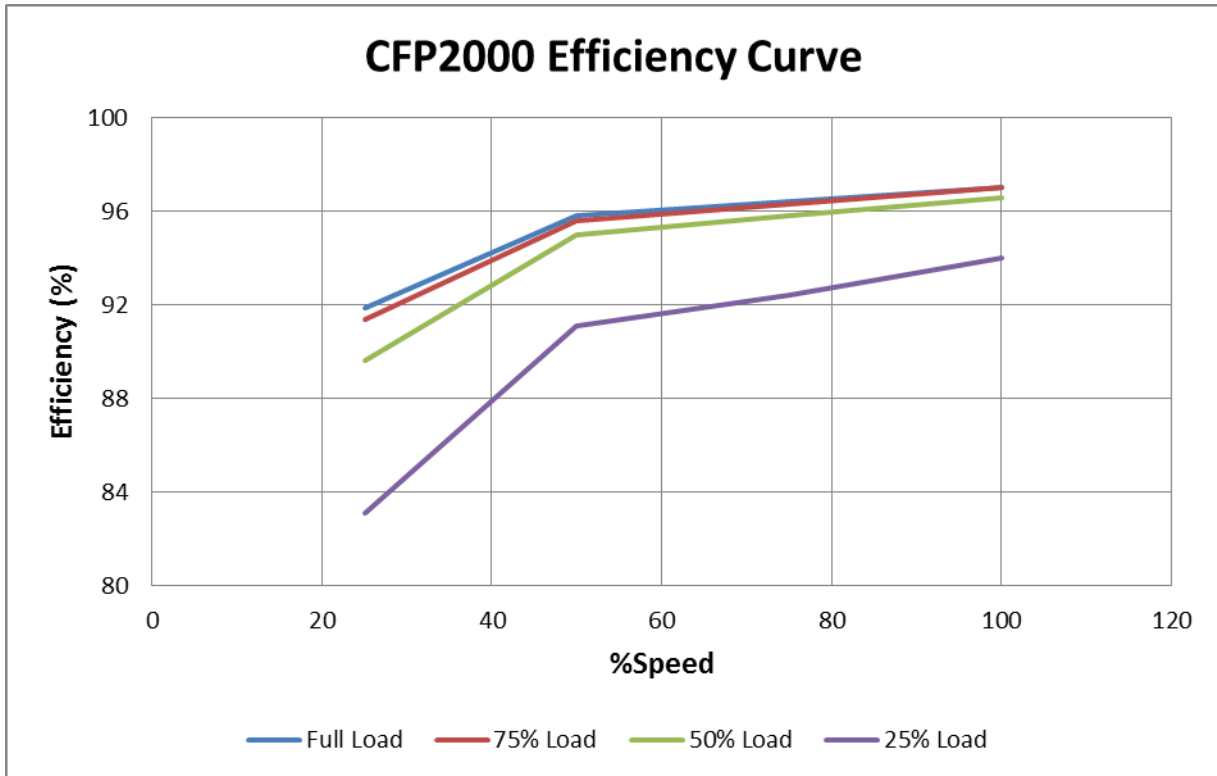

General Specifications

Control Characteristics	Control Method	Pulse-Width Modulation (PWM)
	Control Mode	1: V/F, 2: SVC, 3: PMSVC
	Starting Torque	Reach up to 150% or above at 0.5Hz..
	V/F Curve	4 point adjustable V/F curve and square curve
	Speed Response Ability	5Hz (vector control can reach up to 40Hz)
	Torque Limit	Light duty: a max. of 130% torque current; Normal duty: a max. of 160% torque current
	Torque Accuracy	±5%
	Max. Output Frequency(Hz)	599.00 Hz
	Frequency Output Accuracy	Digital command:±0.01%, -10°C~+40°C; Analog command: ±0.1%, 25±10°C
	Output Frequency Resolution	Digital command: 0.01Hz, Analog command: 0.03 X max. output frequency/60 Hz (±11 bit)
	Overload Tolerance	Normal duty: 120% of rated current can endure for 1 minute during every 5 minutes 160% of rated current can endure for 3 seconds during every 30 seconds. Light duty: 120% of rated current can endure for 1 minute
	Frequency Setting Signal	0~+10V, 4~20mA, 0~20mA
	Accel./decel. Time	0.00~600.00/0.0~6000.0 seconds
Main control function	Momentary power loss ride thru, Speed search, Over-torque detection, Torque limit, 16-step speed (max), Accel/decel time switch, S-curve accel/decel, 3-wire sequence, Auto-Tuning (rotational, stationary), Dwell, Slip compensation, Torque compensation, JOG frequency, Frequency upper/lower limit settings, DC injection braking at start/stop, High slip braking, PID control (with sleep function), Energy saving control, MODBUS communication (RS-485 RJ45, max. 5.2 Kbps)	
Fan Control	Models above VFD300FP4E (including VFD300FP4E) are PWM control Models below VFD220FP4E (including VFD220FP4E) are ON/OFF switch control	
Protection Characteristics	Motor Protection	Electronic thermal relay protection
	Over-current Protection	Light duty: Over-protection for 200% rated current; current clamp: 130~135% Normal duty: Over-protection for 240%; current clamp: 170~175%
	Over-voltage Protection	Drive will stop when DC-BUS voltage exceeds 820V
	Over-temperature Protection	Built-in temperature sensor
	Stall Prevention	Stall prevention during acceleration, deceleration and running independently
	Restart After Instantaneous Power Failure	Parameter setting up to 20 seconds
	Grounding Leakage Current Protection	Leakage current is higher than 50% of rated current of the AC motor drive
	Short-circuit Current Rating (SCCR)	Per UL508C, the drive is suitable for use on a circuit capable of delivering not more than 100kA symmetrical amperes (rms) when protected by fuses given in the fuse table.
Certifications	CE, cULus, GB/T12668-2	

9-2 Environment for Operation, Storage and Transportation

Do NOT expose the AC motor drive in the bad environment, such as dust, direct sunlight, corrosive/inflammable gasses, humidity, liquid and vibration environment. The salt in the air must be less than 0.01mg/cm² every year.

Environment	Installation location	IEC60364-1/IEC60664-1 Pollution degree 2, Indoor use only	
	Surrounding Temperature	Operation	- 15°C ~+ 50°C without derating, +51°C ~ 60°C with derating
		Storage	-25°C ~ +70°C
		Transportation	-25°C ~ +70°C
		Non-condensation, non-frozen	
	Rated Humidity	Operation	Max. 95%
		Storage/ Transportation	Max. 95%
		No condense allowed	
	Atmospheric Pressure	Operation/ Storage	86 to 106 kPa
		Transportation	70 to 106 kPa
	Pollution Level	IEC 60721-3	
		Operation	Class 3C3, Class 3S2
		Storage	Class 1C2, Class 1S2
		Transportation	Class 2C2, Class 2S2
Altitude	Operation	If the AC motor drive is installed at an altitude 0~1000m, follow normal operation restriction. For every 100m increase in altitude, the AC motor drive needs to either lower rated current by 1% or by 0.5°C of temperature for operation. If the drive is installed at an altitude above 2000m, please refer to the voltage derating graph in the user manual for more instructions. Note: Voltage derating is not needed for a Center Ground System, and maximum installation altitude is 4000m.	
Vibration Operating	IEC 60068-2-6		
	Frame A: 2Hz ≤ f ≤ 13.2Hz / Amplitude 1mm; 13.2Hz < f ≤ 55Hz / Gravity 0.7G to 2.0G; 55Hz < f ≤ 512Hz / Gravity 2.0G Frame B: 2Hz ≤ f ≤ 13.2Hz / Amplitude 1mm; 13.2Hz < f ≤ 55Hz / Gravity 0.7G to 1.5G; 55Hz < f ≤ 512Hz / Gravity 1.5G Frame C / D0 / D: 2Hz ≤ f ≤ 13.2Hz / Amplitude 1mm; 13.2Hz < f ≤ 55Hz / Gravity 0.7G to 1.0G; 55Hz < f ≤ 512Hz / Gravity 1.0G		
Shock Operating	IEC 60068-2-27		
	Frame A; B; C; D0: Max 30G; 11 ms Frame D: Max 15G; 11 ms		
In protective shipping package	Vibration	IEC 60068-2-64	
		10Hz ≤ f ≤ 100Hz / ASD: 1.0m2/s3 100Hz ≤ f ≤ 200Hz / Slope: -3dB/octave	
	Shock	Cardboard box type: Free fall drop in accordance with ISTA 1A Wooden box type: In accordance with ISTA 1E (4 side incline) and ISTA 2B (Bottom side drop)	
Operation Position	Maximum permanent angle in relation to the normal vertical mounting position		

9-3 Specifications for Operation Temperature and Protection Level

Model	Frame	Protection Level	Operation Temperature
VFDxxxFPxxx-52	A~D: 0.75~90kW	IP55/NEMA12	-10°C~50°C
VFDxxxFPxxx-41	A~D: 0.75~90kW	IP41/NEMA1	-10°C~50°C

9-4 Derating of ambient temperature and altitude

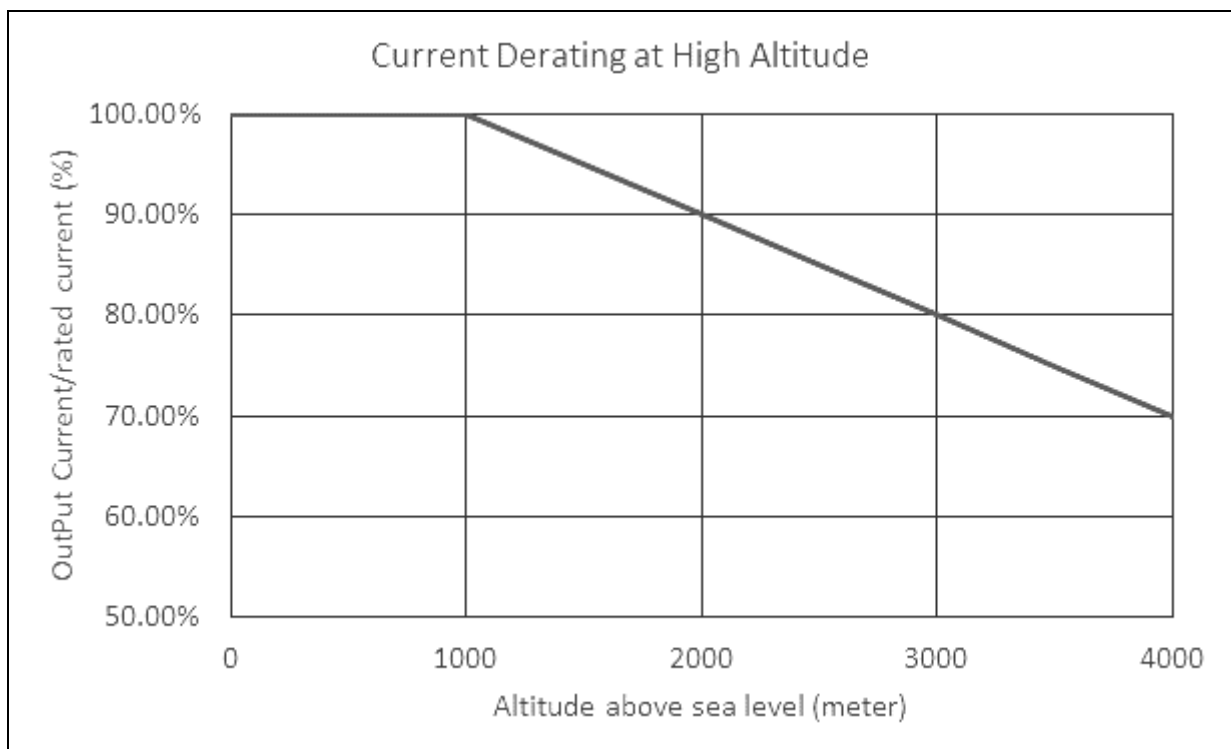
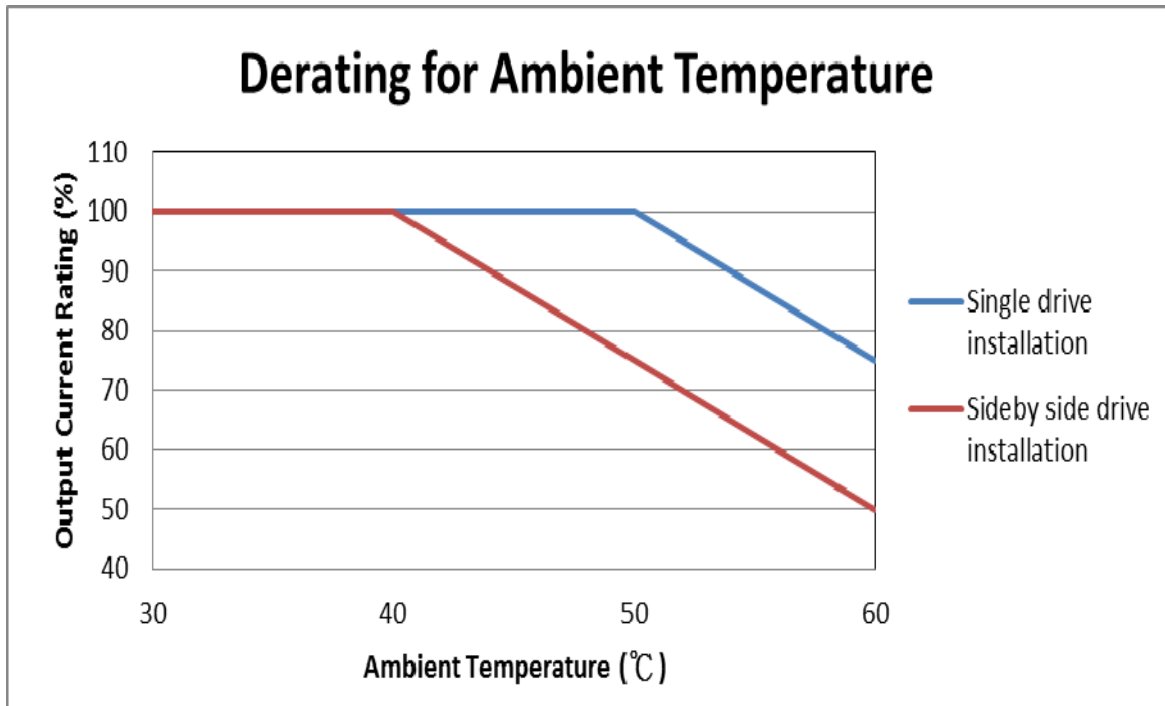

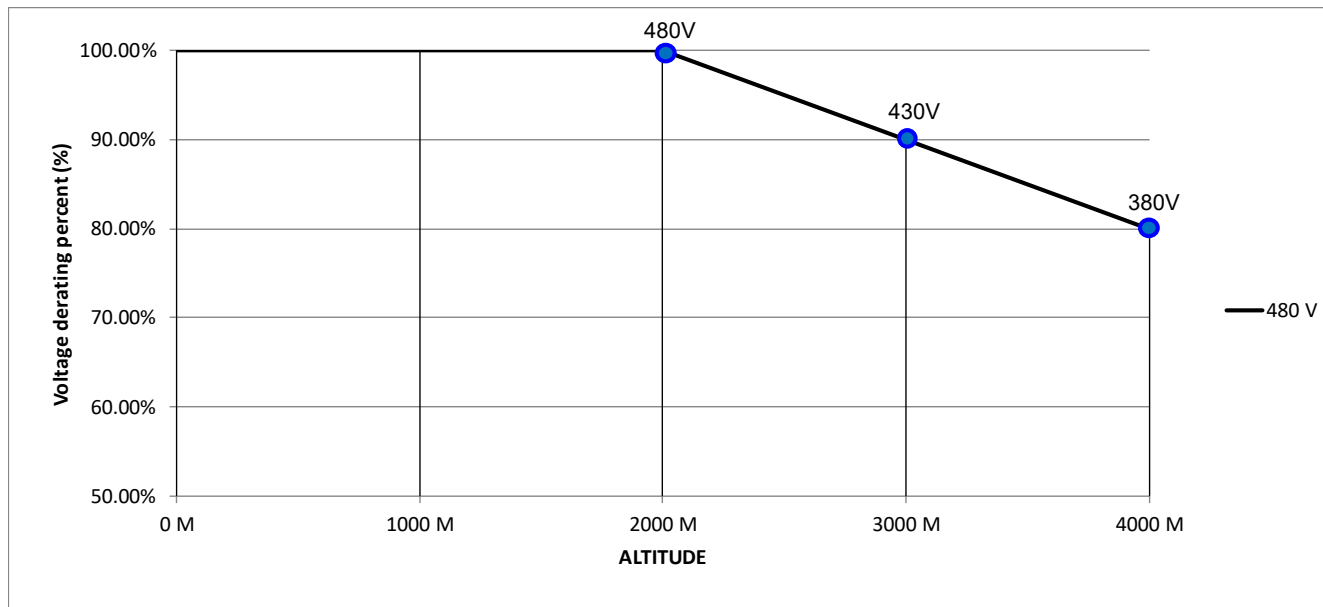

Chapter 10 Digital Keypad

10-1 Descriptions of Digital Keypad

10-2 Function of Digital Keypad KPC-CC02

10-3 TPEditor Installation Instruction

10-4 Fault Code Description of Digital Keypad
KPC-CC02

10-5 Unsupported Functions when using TPEditor on
KPC-CC02

10-1 Descriptions of Digital Keypad

KPC-CC02





Communication Interface
RJ-45 (socket) \ RS-485 interface

Installation Method



1. Embedded type and can be put flat on the surface of the control box. The front cover is water proof.
2. Buy a MKC-KPPK model to do wall mounting or embedded mounting. Its protection level is IP66.
3. The maximum RJ45 extension lead is 5 m (16ft)
4. This keypad can only be used on Delta's motor drive CFP2000.

Descriptions of Keypad Functions

Key	Descriptions															
	Start Operation Key <ol style="list-style-type: none"> 1. It is only valid when the source of operation command is from the keypad. 2. It can operate the AC motor drive by the function setting and the RUN LED will be ON. 3. It can be pressed again and again at stop process. 															
	Stop Command Key. This key has the highest processing priority in any situation. <ol style="list-style-type: none"> 1. When it receives STOP command, no matter the AC motor drive is in operation or stop status, the AC motor drive needs to execute "STOP" command. 2. The RESET key can be used to reset the drive after the fault occurs. 3. The reasons why the error cannot be reset: <ol style="list-style-type: none"> a. Because the condition which triggers the fault is not cleared. When the condition is cleared, the fault can be reset. b. Because it's the fault status checking when power-on. When the condition is cleared, repower again, and the fault can be reset. 															
	Operation Direction Key <ol style="list-style-type: none"> 1. This key only controls the operation direction, NOT for activate the drive. FWD: forward, REV: reverse. 2. Refer to the LED descriptions for more details. 															
	ENTER Key Press ENTER and go to the next level. If it is the last level then press ENTER to execute the command.															
	ESC Key ESC key function is to leave current menu and return to the last menu. It is also functioned as a return key or cancel key in the sub-menu.															
	Press menu to return to main menu. Menu content: <table style="width: 100%; border: none;"> <tr> <td>1. Parameter setup</td> <td>6. Fault Record</td> <td>11. Startup Menu</td> </tr> <tr> <td>2. Copy Parameter</td> <td>7. Quick start</td> <td>12. Main Page</td> </tr> <tr> <td>3. Keypad Locked</td> <td>8. Display Setup</td> <td>13. PC Link</td> </tr> <tr> <td>4. PLC Function</td> <td>9. Time Setup</td> <td>14. Parameter Settings by Applications</td> </tr> <tr> <td>5. Copy PLC</td> <td>10. Language Setup</td> <td>15. History of Parameter Settings</td> </tr> </table>	1. Parameter setup	6. Fault Record	11. Startup Menu	2. Copy Parameter	7. Quick start	12. Main Page	3. Keypad Locked	8. Display Setup	13. PC Link	4. PLC Function	9. Time Setup	14. Parameter Settings by Applications	5. Copy PLC	10. Language Setup	15. History of Parameter Settings
1. Parameter setup	6. Fault Record	11. Startup Menu														
2. Copy Parameter	7. Quick start	12. Main Page														
3. Keypad Locked	8. Display Setup	13. PC Link														
4. PLC Function	9. Time Setup	14. Parameter Settings by Applications														
5. Copy PLC	10. Language Setup	15. History of Parameter Settings														
	Direction: Left / Right / Up / Down <ol style="list-style-type: none"> 1. In the numeric value setting mode, it is used to move the cursor and change the numeric value. 2. In the menu/text selection mode, it is used for item selection. 															
	Function Key <ol style="list-style-type: none"> 1. The functions keys have factory settings and can be defined by users. The factory settings of F1 and F4 work with the function list below. For example, F1 is JOG function, F4 is a speed setting key for adding/deleting user defined parameters. 2. Other functions must be defined by TPEditor first. TPEditor software can be downloaded at: 															

Key	Descriptions
	<p>http://www.dellaww.com/services/DownloadCenter2.aspx?seclD=8&pid=2&tid=0&CID=06&itemID=060302&typeID=1&downloadID=&title=- Select Product Series --&dataType=8:&check=1&hl=en-US Please refer to instruction for TPEditor in Chapter 10-3.</p>
	<p>HAND ON Key</p> <ol style="list-style-type: none"> This key is executed by the parameter settings of the source of Hand frequency and hand operation. The factory settings of both source of Hand frequency and hand operation are the digital keypad. Press HAND ON key at stop status, the setting will switch to hand frequency source and hand operation source. Press HAND ON key at operation status, it stops the AC motor drive first (display AHSP warning), and switch to hand frequency source and hand operation source. Successful mode switching for KPC-CC02, it will display HAND mode on the screen.
	<ol style="list-style-type: none"> This key is executed by the parameter settings of the source of AUTO frequency and AUTO operation. The factory setting is the external terminal (source of operation is 4-20mA). Press Auto key at stop status, the setting will switch to hand frequency source and hand operation source. Press Auto key at operation status, it stops the AC motor drive first (display AHSP warning), and switch to auto frequency source and auto operation source. Successful mode switching for KPC-CC02, it will display AUTO mode on the screen

Descriptions of LED Functions

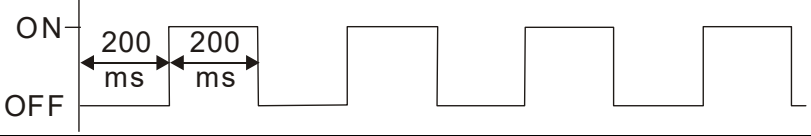
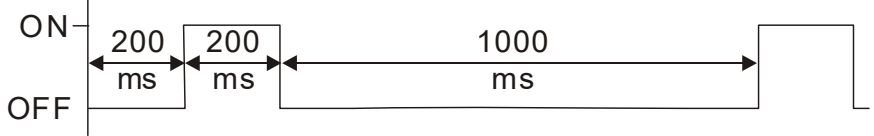
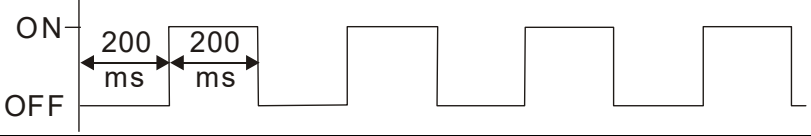
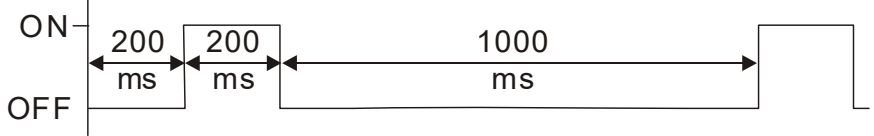
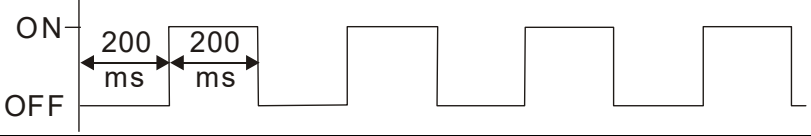
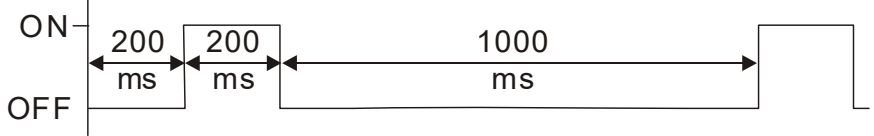
LED	Descriptions										
	<p>Steady ON: operation indicator of the AC motor drive, including DC brake, zero speed, standby, restart after fault and speed search. Blinking: drive is decelerating to stop or in the status of base block. Steady OFF: drive doesn't execute the operation command</p>										
	<p>Steady ON: stop indicator of the AC motor drive. Blinking: drive is in the standby status. Steady OFF: drive doesn't execute "STOP" command.</p>										
	<p>Operation Direction LED</p> <ol style="list-style-type: none"> Green light is on, the drive is running forward. Red light is on, the drive is running backward. Twinkling light: the drive is changing direction. <p>Operation Direction LED under Torque Mode</p> <ol style="list-style-type: none"> Green light is on: the drive is running forward when the torque command is > 0. Red light is on: the drive is running backward when the torque command is < 0. Twinkling light: the drive is running forward when the torque command is < 0. 										
CANopen~ "RUN"	<p>RUN LED:</p> <table border="1"> <thead> <tr> <th>LED status</th> <th>Condition/State</th> </tr> </thead> <tbody> <tr> <td>OFF</td> <td>CANopen at initial No LED</td> </tr> <tr> <td>Blinking</td> <td>CANopen at pre-operation  </td> </tr> <tr> <td>Single flash</td> <td>CANopen at stopped  </td> </tr> <tr> <td>ON</td> <td>CANopen at operation status No LED</td> </tr> </tbody> </table>	LED status	Condition/State	OFF	CANopen at initial No LED	Blinking	CANopen at pre-operation 	Single flash	CANopen at stopped 	ON	CANopen at operation status No LED
	LED status	Condition/State									
	OFF	CANopen at initial No LED									
	Blinking	CANopen at pre-operation 									
	Single flash	CANopen at stopped 									
ON	CANopen at operation status No LED										

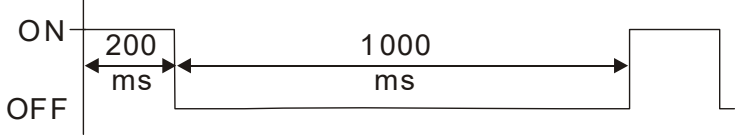
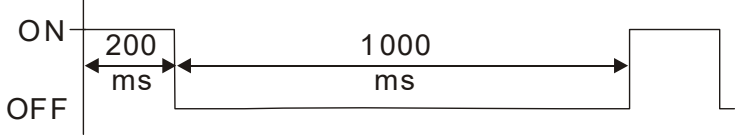
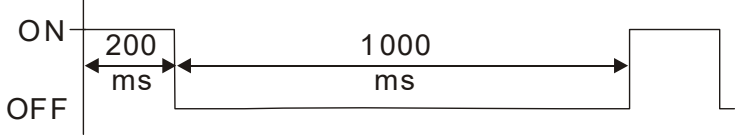
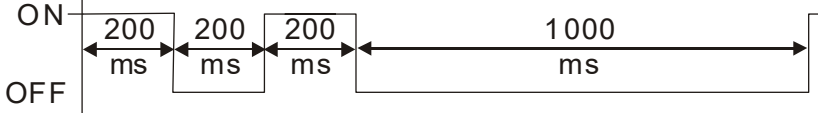
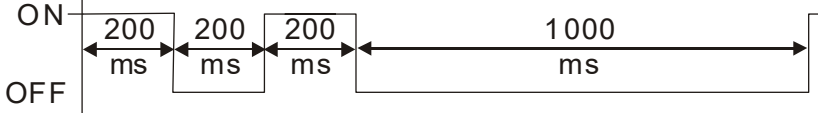
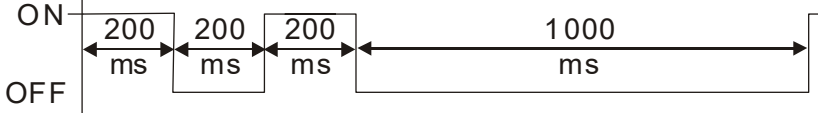
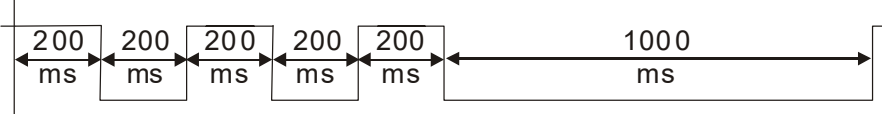
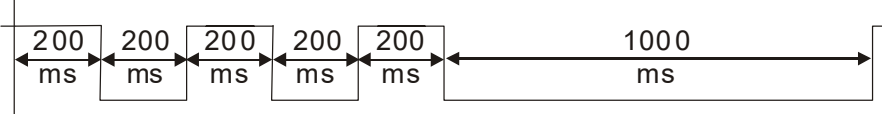
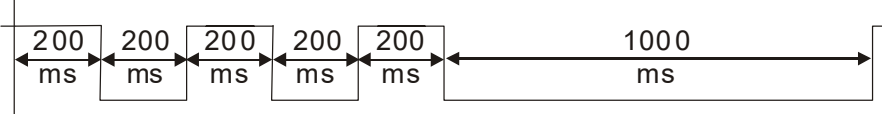
LED	Descriptions				
CANopen~ "ERR"	ERR LED:				
	<table border="1"> <thead> <tr> <th data-bbox="355 224 491 284">LED status</th> <th data-bbox="491 224 1465 284">Condition/ State</th> </tr> </thead> <tbody> <tr> <td data-bbox="355 284 491 315">OFF</td> <td data-bbox="491 284 1465 315">No Error</td> </tr> </tbody> </table>	LED status	Condition/ State	OFF	No Error
	LED status	Condition/ State			
	OFF	No Error			
	<table border="1"> <tbody> <tr> <td data-bbox="355 315 491 508">Single flash</td> <td data-bbox="491 315 1465 508"> One message fail  </td> </tr> </tbody> </table>	Single flash	One message fail 		
	Single flash	One message fail 			
<table border="1"> <tbody> <tr> <td data-bbox="355 508 491 683">Double flash</td> <td data-bbox="491 508 1465 683"> Guarding fail or heartbeat fail  </td> </tr> </tbody> </table>	Double flash	Guarding fail or heartbeat fail 			
Double flash	Guarding fail or heartbeat fail 				
<table border="1"> <tbody> <tr> <td data-bbox="355 683 491 862">Triple flash</td> <td data-bbox="491 683 1465 862"> SYNC fail  </td> </tr> </tbody> </table>	Triple flash	SYNC fail 			
Triple flash	SYNC fail 				
<table border="1"> <tbody> <tr> <td data-bbox="355 862 491 934">ON</td> <td data-bbox="491 862 1465 934">Bus off</td> </tr> </tbody> </table>	ON	Bus off			
ON	Bus off				

10-2 Function of Digital Keypad KPC-CC02

POWER ON



Start-up

Skip to main page
after 3sec.

- 1) The default Start-up page is Delta Logo. (Default 1 and 2)
- 2) User can customize their start-up page through the edited function. (Need to purchase the optional accessories)



AUTO

F 60.00Hz

H 0.00Hz

A 0.00

JOG 1435:36

→ The top line of LCD displays the status of drive.

After main menu is selected, the start-up page will display in the format user defined. The page shown on the left is display as Delta default setting.

→ The button line of LCD displays time and JOG.



Press MENU

MENU

▼ 1. Detail Parameter
2. Copy Parameter
3. Keypad Locked

MENU

- | | | |
|--|---|---|
| <ol style="list-style-type: none"> 1. Detail Parameter 2. Copy Parameter 3. Keypad Locked 4. PLC Function 5. Copy PLC | <ol style="list-style-type: none"> 6. Fault Record 7. Quick/Simple Setup 8. Display Setup 9. Time Setup 10. Language Setup | <ol style="list-style-type: none"> 11. Start-up 12. Main page 13. PC Link 14. Parameter Settings
by Applications 15. History of Parameter
Settings |
|--|---|---|

Press ▼ once

AUTO

F 60.00Hz

H 0.00Hz

A 0.00

JOG 1435:36

Press ▼ again

AUTO

F 60.00Hz

H 0.00Hz

A 0.00

JOG 1435:36

Press ▼ again

AUTO

H 0.00Hz

A 0.00

A 0.00 Amp

JOG 1435:36

NOTE

1. Startup page can only display pictures, no flash.
2. When Power ON, it will display startup page then the main page. The main page displays Delta's default setting F/H/A/U, the display order can be set by Pr.00.03 (Startup display). When the selected item is U page, use left key and right key to switch between the items, the display order of U page is set by Pr.00.04 (User display).

Display Icon

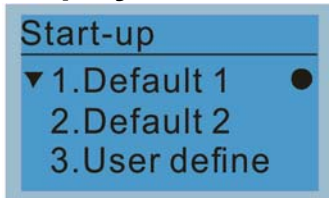

- : present setting
- ▼ : roll down the page for more options

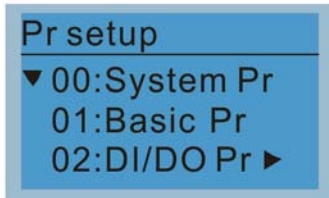

- ▶ : show complete sentence
- Press [left] [right] for complete information

Display item

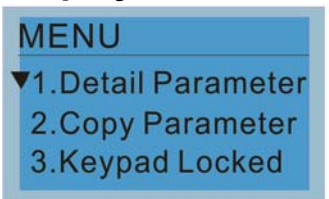

MENU

- | | | |
|---------------------|-----------------------|--|
| 1. Detail Parameter | 6. Fault Record | 11. Start-up |
| 2. Copy Parameter | 7. Quick/Simple Setup | 12. Main page |
| 3. Keypad Locked | 8. Display Setup | 13. PC Link |
| 4. PLC Function | 9. Time Setup | 14. Parameter Settings by Applications |
| 5. Copy PLC | 10. Language Setup | 15. History of Parameter Settings |

1. Parameter Setup

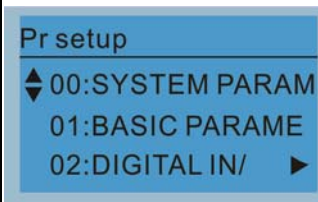
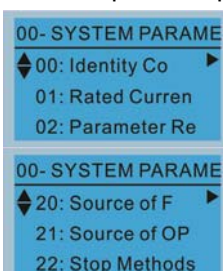
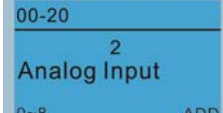
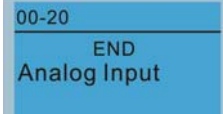



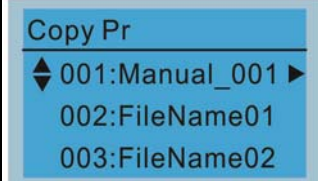
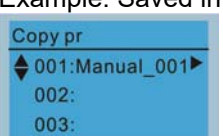
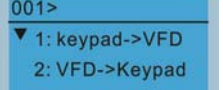

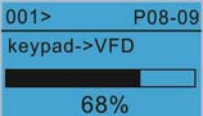
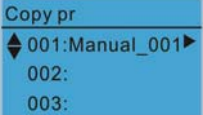
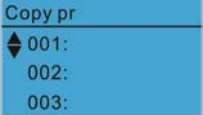
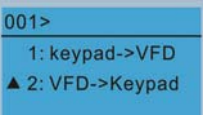
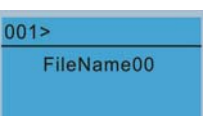
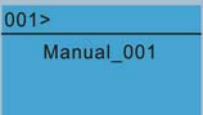
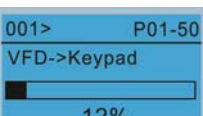
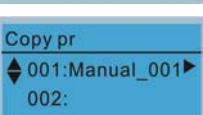
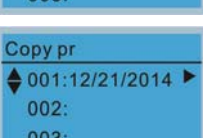
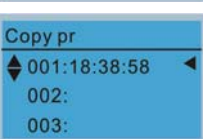
 <p>Press ENTER key to select. Press Up/Down key to select parameter group. Once a parameter group is selected, press ENTER key to go into that group.</p>	<p>For example: Setup source of master frequency command.</p>  <p>Once in the Group 00 Motor Drive Parameter, Use Up/Down key to select parameter 20: Auto Frequency Command.</p>  <p>When this parameter is selected, press ENTER key to go to this parameter's setting menu.</p> <p>Use Up/Down key to choose a setting. For example: Choose "2 Analogue Input, then press the ENTER key.</p>  <p>After pressing the ENTER key, an END will be displayed which means that the parameter setting is done.</p>
---	---

2. Copy Parameter

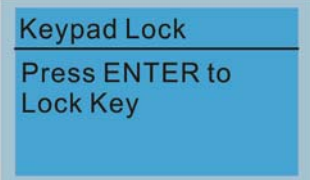

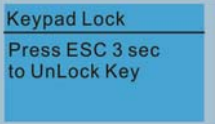

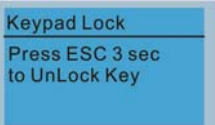

 <p>Press ENTER key to go to 001~004: content storage</p>	<p>4 duplicates are provided</p> <p>The steps are shown in the example below.</p> <p>Example: Saved in the motor drive.</p>  <p>1 Go to Copy Parameter 2 Select the parameter group which needs to be copied and press ENTER key.</p>  <p>1 Select 1: Save in the motor drive. 2. Press ENTER key to go to "Save in the motor drive" screen.</p>
--	--

	<p>Begin to copy parameters until it is done.</p>
	<p>Once copying parameters is done, keypad will automatically be back to this screen.</p>
<p>Example: Saved in the keypad.</p>	
	<ol style="list-style-type: none"> 1. Once copying parameters is done, keypad will automatically be back to this screen. 2. Select the parameter group which needs to be copied and press ENTER key.
	<p>Press ENTER key to go to “Save in the motor drive” screen.</p>
	<p>Use Up/Down key to select a symbol. Use Left/Right key to move the cursor to select a file name.</p>
<p>String & Symbol Table: ! ” # \$ % & ’ () * + , - . / 0 1 2 3 4 5 6 7 8 9 : ; < = > ? @ A B C D E F G H I J K L M N O P Q R S T U V W X Y Z [\] ^ _ ‘ a b c d f g h i j k l m n o p q r s t u v w x y z { } ~</p>	
	<p>Once the file name is confirmed, press ENTER key.</p>
	<p>To begin copying parameters until it is done.</p>
	<p>When copying parameters is completed, keypad will automatically be back to this screen.</p>
	<p>Press Right key to see the date of copying parameters.</p>
	<p>Press Right key to see the time of copying parameters.</p>

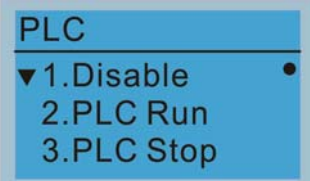
3. Keypad locked

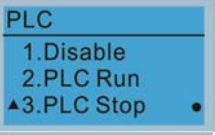
	<p>Keypad Locked</p> <p>This function is used to lock the keypad. The main page would not display “keypad locked” when the keypad is locked, however it will display the message “please press ESC and then ENTER to unlock the keypad” when any key is pressed.</p>
<p>Press ENTER key to lock.</p>	 <p>When the keypad is locked, the main screen doesn't display any status to show that.</p>
	 <p>Press any key on the keypad; a screen as shown in image on the left will be displayed.</p>
	 <p>If ESC key is not pressed, the keypad will automatically be back to this screen.</p>
	 <p>The keypad is still locked at this moment. By pressing any key, a screen as shown in the image on the left will still be displayed.</p>
	 <p>Press ESC for 3 seconds to unlock the keypad and the keypad will be back to this screen. Then each key on the keypad is functional.</p> <p>Turn off the power and turn on the power again will not lock keypad.</p>

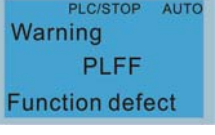
4. PLC Function



	<p>When activate and stop PLC function, the PLC status will be displayed on main page of Delta default setting.</p>
<p>Press Up/Down key to select a PLC's function. Then press ENTER.</p>	 <p>Option 2: Enable PLC function</p>
	 <p>Factory setting on the main screen displays PLC/RUN status bar.</p>
	 <p>Option 3: Disable PLC function</p>
	 <p>Factory setting on the main screen displays PLC/STOP status bar</p>
	 <p>If the PLC program is not available in the control board, PLFF warning will be displayed when choosing option 2 or 3. In this case, select option 1: No Function to clear PLFF warning.</p>

5. Copy PLC

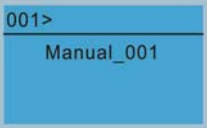
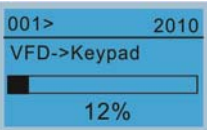
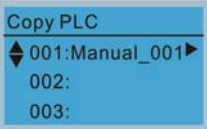
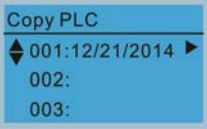
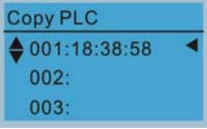
	<p>4 duplicates are provided</p> <p>The steps are shown in the example below.</p>
	<p>Example: Saved in the motor drive.</p> <p>1 Go to Copy PLC</p> <p>2 Select a parameter group to copy then press ENTER</p>
	<p>1 Select 1: Save in the motor drive.</p> <p>2. Press ENTER key to go to “Save in the motor drive” screen.</p>
	<p>Begin to copy PLC until it is done.</p>
	<p>Once copying PLC is done, keypad will automatically be back to this screen.</p>
<p>NOTE</p>	<p>If “Option 1: Save in the motor drive” is selected, verify if the PLC program is built-in to KPC-CC02 keypad. If PLC program is not available in the keypad while “Option 1: Save in the motor drive” is selected, an “ERR8 Warning: Type not matching” will be display on the screen.</p>
	<p>Unplug and plug back the keypad while copying the PLC program will have a CPLt warning.</p>
<p>Example: Saved in the keypad.</p>	
	<p>1. Once copying PLC is done, keypad will automatically be back to this screen.</p> <p>2. Select the parameter group which needs to be copied and press ENTER key.</p>
	<p>Press ENTER key to go to “Save in the motor drive” screen.</p>
	<p>If WPLSoft editor is installed and password is set, enter the password to save the file onto digital display.</p>
	<p>Use Up/Down key to select a symbol.</p> <p>Use Left/Right key to move the cursor to select a file name.</p>
<p>String & Symbol Table: !” # \$ % & ’ () * + , - . / 0 1 2 3 4 5 6 7 8 9 : ; < = > ? @ A B C D E F G H I J K L M N O P Q R S T U V W X Y Z { \ } ^ _ ‘ a b c d f g h i j k l m n o p q r s t u v w x y z { } ~</p>	

		<p>Once the file name is confirmed, press ENTER key.</p>
		<p>To begin copying parameters until it is done.</p>
		<p>When copying parameters is completed, keypad will automatically be back to this screen.</p>
		<p>Press Right key to see the date of copying parameters.</p>
		<p>Press Right key to see the time of copying parameters.</p>

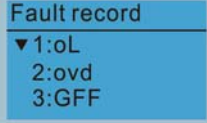
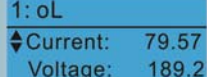
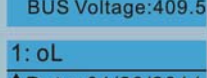
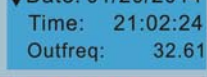
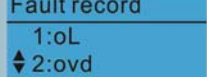
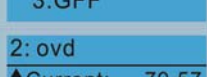
6. Fault record

	<p>Able to store 20 error code (Keypad V1.10 and previous versions) Able to store 30 error code (Keypad V1.20 and later version) The most recent error record is shown as the first record. Select an error record to see its detail such as date, time, frequency, current, voltage, DCBUS voltage)</p>	
<p>Press ENTER key to select.</p>		
		<p>Press Up/Down key to select an error record. After selecting an error code, press ENTER to see that error record's detail</p>
		
		<p>Press Up/Down key to see an error record's detail such as date, time, frequency, current, voltage, DCBus voltage.</p>
		<p>Press Up/Down key to select an error record. After selecting an error code, press ENTER to see that error record's detail</p>
		
		<p>Press Up/Down key to see an error record's detail such as date, time, frequency, current, voltage, DCBus voltage.</p>
	<p> NOTE Fault actions of AC motor drive are record and save to KPC-CC02. When KPC-CC02 is removed and apply to another AC motor drive, the previous fault records will not be deleted. The new fault records of the present AC motor drive will accumulate to KPC-CC02.</p>	

7. Quick Start

<div style="border: 1px solid black; background-color: #e0e0e0; padding: 5px; margin-bottom: 5px;"> <p>Quick Start</p> <p>▼ 1: V/F Mode 2: VFPG Mode 3: SVC Mode</p> </div> <p>Press ENTER key to select.</p> <p>Quick Start:</p> <ol style="list-style-type: none"> 1. V/F Mode 2. SVC Mode 3. My Mode 	<p>1. VF Mode</p> <div style="border: 1px solid black; background-color: #e0e0e0; padding: 5px; margin-bottom: 5px;"> <p>V/F Mode :P00-07</p> <p>◆01:Password De 02:Password Inp 03:Control Meth</p> </div> <p>01:Password Decoder</p> <div style="border: 1px solid black; background-color: #e0e0e0; padding: 5px; margin-bottom: 5px;"> <p>00-07</p> <p>0</p> <p>Password Decoder</p> <p>0~65535</p> </div> <p>Items</p> <ol style="list-style-type: none"> 1. Parameter Protection Password Input (P00-07) 2. Parameter Protection Password Setting (P00-08) 3. Control Mode (P00-10) 4. Control of Speed Mode (P00-11) 5. Load Selection (P00-16) 6. Carrier Frequency (P00-17) 7. Source of the Master Frequency Command (AUTO) (P00-20) 8. Source of the Operation Command (AUTO) (P00-21) 9. Stop Method (P00-22) 10. Digital Keypad STOP function (P00-32) 11. Max. Operation Frequency (P01-00) 12. Max. Frequency of Motor 1 (P01-01) 13. Max. Output Voltage Setting of Motor 1 (P01-02) 14. Mid-point Frequency 1 of Motor 1 (P01-03) 15. Mid-point Voltage 1 of Motor 1 (P01-04) 16. Mid-point Frequency 2 of Motor 2 (P01-05) 17. Mid-point Voltage 2 of Motor 2 (P01-06) 18. Min. Output Frequency of Motor 1 (P01-07) 19. Min. Output Voltage of Motor 1 (P01-08) 20. Output Frequency Upper Limit (P01-10) 21. Output Frequency Lower Limit (P01-11) 22. Accel. Time 1 (P01-12) 23. Decel Time 1 (P01-13) 24. Over-voltage Stall Prevention (P06-01) 25. Derating Protection (P06-55) 26. Software Brake Level (P07-00) 27. Speed Tracking during Start-up (P07-12) 28. Emergency Stop & Force to Stop Selection (P07-20) 29. Filter Time of Torque Command (P07-24) 30. Filter Time of Slip Compensation (P07-25) 31. Torque Compensation Gain (P07-26) 32. Slip Compensation Gain (P07-27) <p>2. SVC Mode</p> <div style="border: 1px solid black; background-color: #e0e0e0; padding: 5px; margin-bottom: 5px;"> <p>SVC Mode :P00-07</p> <p>◆01:Password De 02:Password Inp 03:Control Meth</p> </div> <p>01: Password Decoder</p> <div style="border: 1px solid black; background-color: #e0e0e0; padding: 5px; margin-bottom: 5px;"> <p>00-07</p> <p>0</p> <p>Password Decoder</p> <p>0~65535</p> </div> <p>Items</p> <ol style="list-style-type: none"> 1. Parameter Protection Password Input (P00-07) 2. Parameter Protection Password Setting (P00-08) 3. Control Mode (P00-10) 4. Control of Speed Mode (P00-11) 5. Load Selection (P00-16) 6. Carrier Frequency (P00-17) 7. Source of the Master Frequency Command (AUTO) (P00-20) 8. Source of the Operation Command (AUTO) (P00-21) 9. Stop Method (P00-22) 10. Digital Keypad STOP function (P00-32) 11. Max. Operation Frequency (P01-00)
---	---

- 12. Base Frequency of Motor 1 (P01-01)
- 13. Max. Output Voltage Setting of Motor 1 (P01-02)
- 14. Min. Output Frequency of Motor 1 (P01-07)
- 15. Min. Output Voltage of Motor 1 (P01-08)
- 16. Output Frequency Upper Limit (P01-10)
- 17. Output Frequency Lower Limit (P01-11)
- 18. Accel. Time 1 (P01-12)
- 19. Decel Time 1 (P01-13)
- 20. Full-load Current of Induction Motor 1 (P05-01)
- 21. Rated Power of Induction Motor 1 (P05-02)
- 22. Rated Speed of Induction Motor 1 (P05-03)
- 23. Pole Number of Induction Motor 1 (P05-04)
- 24. No-load Current of Induction Motor 1 (P05-05)
- 25. Over-voltage Stall Prevention (P06-01)
- 26. Over-current Stall Prevention during Acceleration (P06-03)
- 27. Derating Protection (P06-55)
- 28. Software Brake Level (P07-00)
- 29. Emergency Stop (EF) & Force to Stop Selection (P07-20)
- 30. Filter Time of Torque Command (P07-24)
- 31. Filter Time of Slip Compensation (P07-25)
- 32. Slip Compensation Gain (P07-27)

3. My Mode

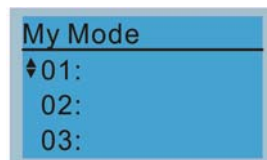

Click F4 in parameter setting page, the parameter will save to My Mode. To delete or correct the parameter, enter this parameter and click the “DEL” on the bottom right corner.

Items

It can save 01~32 sets of parameters (Pr).

Setup process

1. Go to Parameter Setup function.



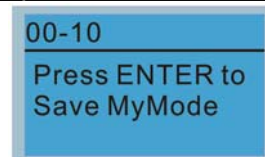

Press ENTER to select the parameter which you need to use. There is an ADD on the bottom right-hand corner of the screen. Press F4 on the key pad to add this parameter to My Mode.

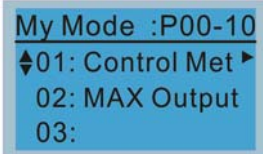
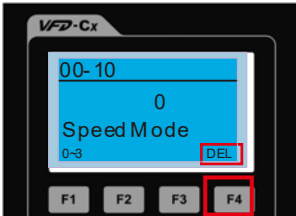
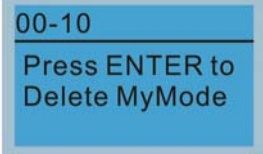
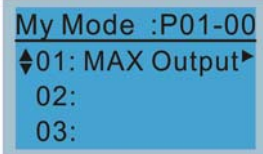





2. The parameter (Pr) will be displayed in My mode if it is properly saved. To correct or to delete this Pr., click

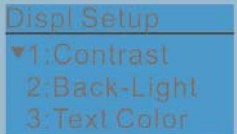

	<p style="text-align: right;">DEL.</p>  <p>3. To delete a parameter, go to My Mode and select a parameter which you need to delete. Press ENTER to enter the parameter setting screen. There is a DEL on the bottom left-hand corner of the screen. Press F4 on the keypad to delete this parameter from My Mode.</p>   <p>4. After pressing ENTER to delete <01 Control Mode>, the <02 Maximum Operating Frequency > will automatically replace <01 Control Mode>.</p> 
--	--

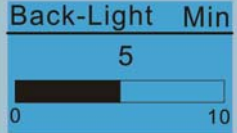
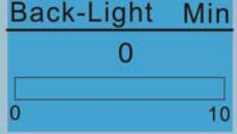
8. Display setup

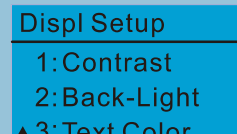
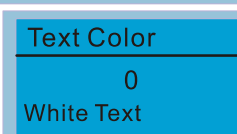
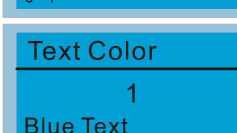
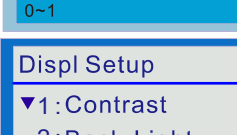
 <p>Press ENTER key to setting menu.</p>	<p>1. Contrast</p>    	<p>Use Up/Down key to adjust the setting value.</p> <p>Then press ENTER.</p> <p>After selecting a setting value. Press ENTER to see screen's display after contrast is adjusted to be +10.</p> <p>Then press ENTER.</p>
---	--	---

		<p>After select a setting value Press ENTER to see screen's display result after contrast is adjusted to be -10.</p>
	<p>2. Back-light</p>    	<p>Press ENTER to go to Back Light Time Setting screen.</p> <p>Use Up / Down key to adjust the setting value.</p> <p>When the setting value is 0 Min, the back light will be steady on.</p> <p>When the setting value is 10 Min, the backlight will be off in 10 minutes.</p>
	<p>3. Text Color</p>    	<p>Press ENTER to go to Text Color Setting screen.</p> <p>The default value is White Text.</p> <p>Use Up / Down key to adjust the setting value.</p> <p>The setting value changes to Blue Text.</p>

9. Time setting

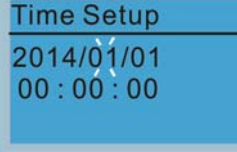
 <p>Use Left/Right key to select Year, Month, Day, Hour, Minute or Second to set up</p>	 	<p>Use Up/Down key to set up Year</p> <p>Use Up/Down key to set up Month</p>
--	---	--

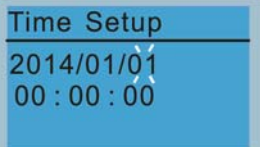
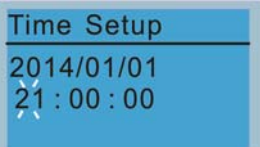
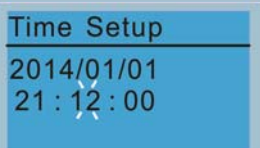
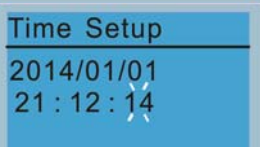
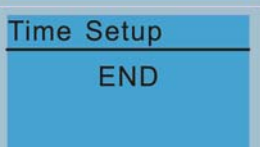
	<p>Use Up/Down key to set up Day</p>
	<p>Use Up/Down key to set up Hour</p>
	<p>Use Up/Down key to set up Minute</p>
	<p>Use Up/Down key to set up Second</p>
	<p>After setting up, press ENTER to confirm the setup.</p>



 **NOTE**

Limitation: The charging process of the super capacitor will finish in about 6 minutes. When the digital keypad is removed, the time setting will be in standby status for 7 days. After this period, the time needs to be reset.

10. Language setup

	<p>Language setting option is displayed in the language of the user's choice. Language setting options:</p>										
<p>Use Up/Down key to select language, than press ENTER.</p>	<table border="0"> <tr> <td>1. English</td> <td>5. Русский</td> </tr> <tr> <td>2. 繁體中文</td> <td>6. Español</td> </tr> <tr> <td>3. 简体中文</td> <td>7. Português</td> </tr> <tr> <td>4. Türkçe</td> <td>8. Français</td> </tr> <tr> <td></td> <td>9. Polski</td> </tr> </table>	1. English	5. Русский	2. 繁體中文	6. Español	3. 简体中文	7. Português	4. Türkçe	8. Français		9. Polski
1. English	5. Русский										
2. 繁體中文	6. Español										
3. 简体中文	7. Português										
4. Türkçe	8. Français										
	9. Polski										

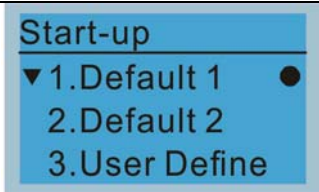
11. Start-up

	<p>1. Default 1 DELTA LOGO</p>
	
	<p>2. Default 2 DELTA Text</p>
	

	<p>3. User Defined: optional accessory is require (TPEditor & USB/RS-485 Communication Interface-IFD6530)</p> <p>Install an editing accessory would allow users to design their own start-up page. If editor accessory is not installed, “user defined” option will display a blank page.</p>  <p>DELTA VFD C2000 X-Y-Z 3-axis station X-axis</p> <p><u>USB/RS-485 Communication Interface-IFD6530</u> Please refer to Chapter 07 Optional Accessories for more detail.</p> <p><u>TPEditor</u> Go to Delta’s website to download TPEditor V1.60 or later versions. http://www.deltaww.com/services/DownloadCenter2.aspx?seclD=8&pid=2&tid=0&CID=06&itemID=060302&typeID=1&dowloadID=&title=-- Select Product Series --&dataType=8;&check=1&hl=en-US</p>
--	--

12. Main page

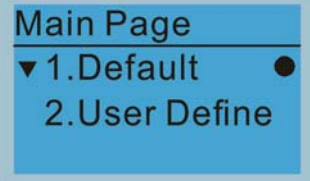
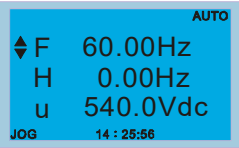
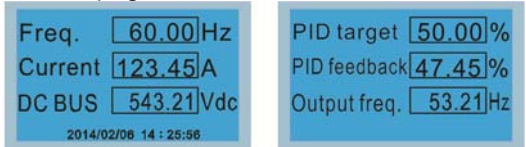
 <p>Default picture and editable picture are available upon selection. Press ENTER key to select.</p>	<p>1. Default page</p>  <p>F 60.00Hz >>> H >>> A >>> U (circulate)</p> <p>2. User Defined: optional accessory is require (TPEditor & USB/RS-485 Communication Interface-IFD6530)</p> <p>Install an editing accessory would allow users to design their own start-up page.If editor accessory is not installed, “user defined” option will display a blank page.</p>  <p><u>USB/RS-485 Communication Interface-IFD6530</u> Please refer to Chapter 07 Optional Accessories for more detail.</p> <p><u>TPEditor</u> Go to Delta’s website to download TPEditor V1.60 or later versions. http://www.deltaww.com/services/DownloadCenter2.aspx?seclD=8&pid=2&tid=0&CID=06&itemID=060302&typeID=1&dowloadID=&title=-- Select Product Series --&dataType=8;&check=1&hl=en-US</p>
--	--

13. PC Link

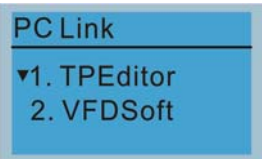
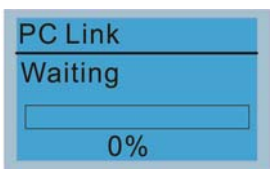
	<p>1. TPEditor: This function allows users to connect the keypad to a computer then to download and edit user defined pages.</p>  <p>Click ENTER to go to <Waiting to connect to PC></p>
---	---

In TPEditor, choose <Communication>, then choose “Write to HMI”

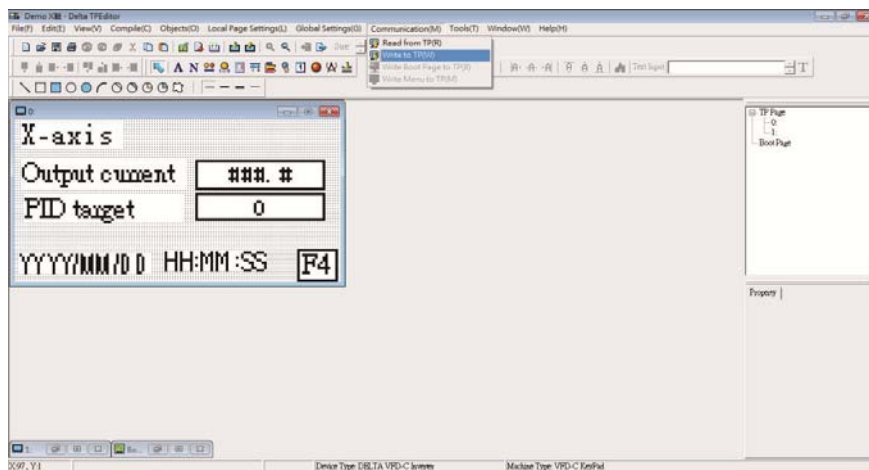

Choose <YES> in the <Confirm to Write> dialogue box.

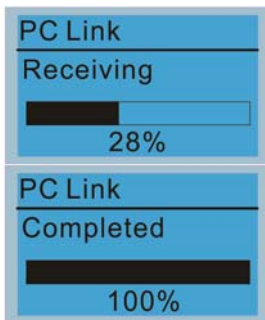
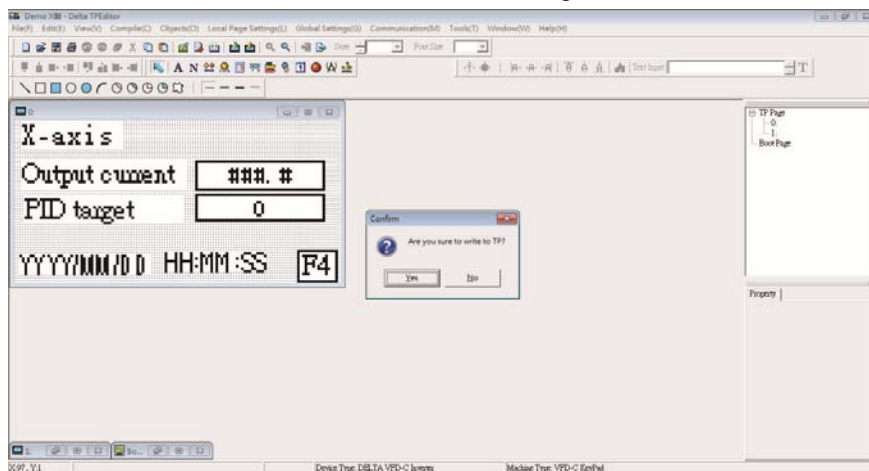

Start downloading pages to edit KPC-CC02.

Download completed

2. VFDSOft: this function allows user to link to the VFDSOft Operating software then to upload data

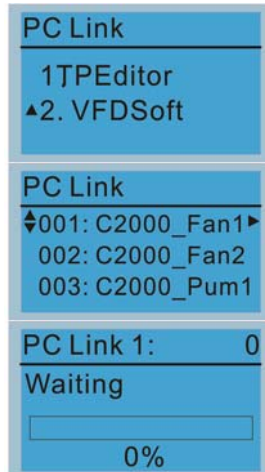

Start downloading pages to edit to KPC-CC02

Use Up/Down key to select a parameter group to upload to VFDSOft. Press ENTER

Waiting to connect to PC

Open VFDSOft, choose <Parameter Manager function>

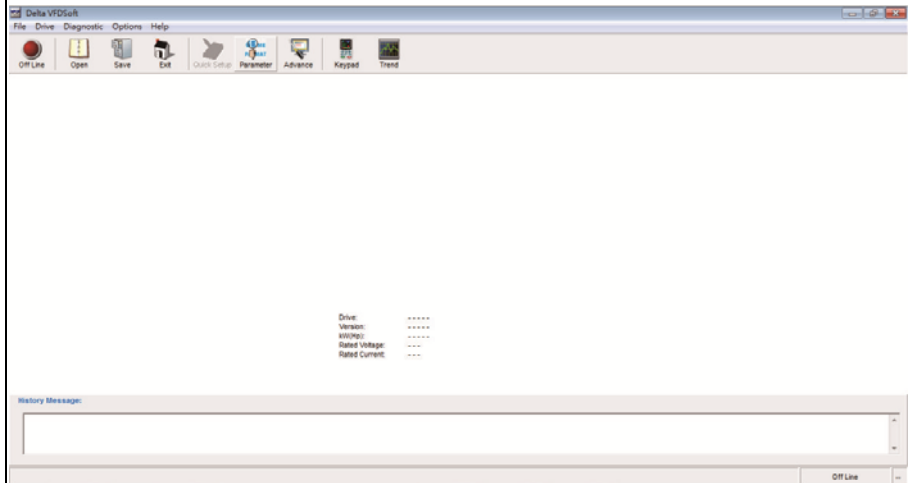

In Parameter Manager, choose <Load parameter table from KPC-CC02>

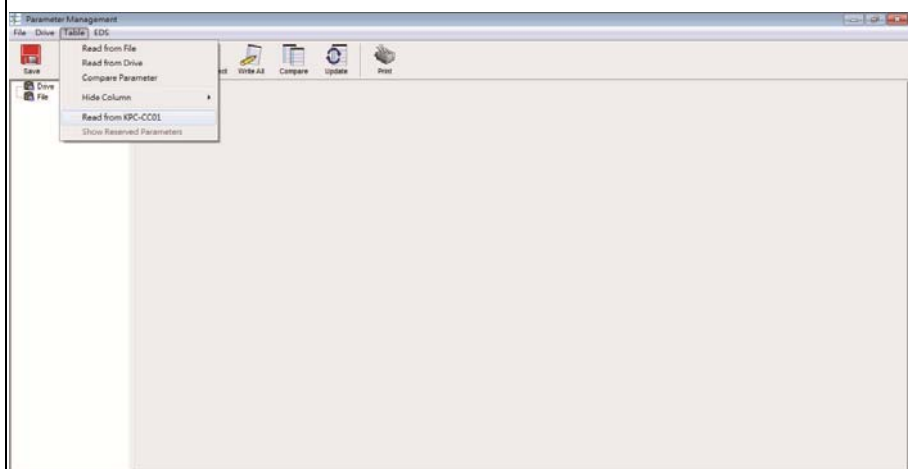

Choose the right communication port and click OK

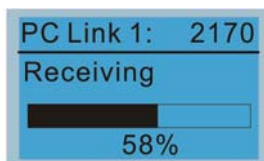
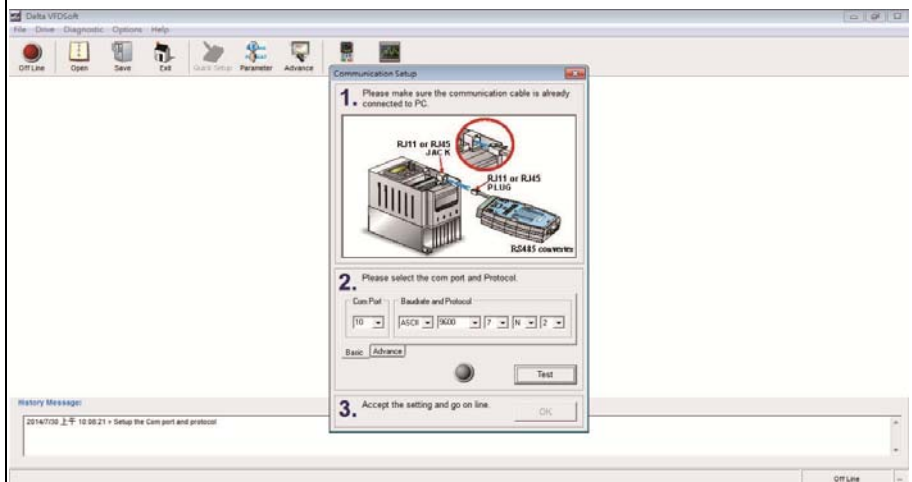

Start to upload parameters to VFDSOft

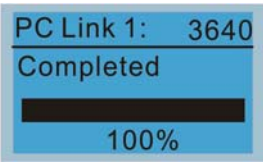

Uploading parameter is completed

Before using the user defined starting screen and user defined main screen, the starting screen setup and the main screen setup have to be preset as user defined.

If the user defined page is not downloaded to KPC-CC02, the starting screen and the main screen will be blank.

14. Application Selection List

App Sel List
No Function
List PrNum =000

Select" Macro / User Define Macro" then set relevant parameters in"Application Selection List".

Application Selection List is the collection focusing on common used parameters for industry application, which is providing user the required parameter groups according to application; hence it also can change the value of the modified parameters to achieve a more rapid and convenient parameter settings.

Application Selection List operation associated charts is as below showing.

Application Selection
(Group 13)

⇒

Application Selection List
(Main page 14)

⇒

Parameter Changed List
(Main page 15)

	Application Selection	Application Selection List	Parameter Changed List
Pr. location	Group 13 (parameter setting)	Main page 14	Main page 15
Function	Enter & edit parameter location	Set the value of parameter	Parameter changed list reference & Set the value of parameter
Operation	Set parameter 13-00=2~10(2~10:application selection;1:user parameter)	<ul style="list-style-type: none"> ■ In application selection list · press ENTER 2 times it will show the related parameters. ■ Use up/down key to select application selection list · then press ENTER to set parameter value. 	<ul style="list-style-type: none"> ■ In parameter changed list · press ENTER2 times it will enter the changed list.
Disable	Edit the value of parameter	Edit the location of parameter	Edit the location of parameter

Into the Application Selection page(during Pr.13-00≠0) · then press ENTER into Application Selection List · it will show the corresponding settings according to application list (13-00) · and then press ENTER key to see the user-defined or other application parameter groups,the parameter setting is the same as the general case, you can press the up/down key to select the parameters you want to change.

Operation Steps:

1. Choose "Parameter setting" group 13 then select the application which you want in "Application Selection List", the setting list is as below:

13-00=0 :Disabled (Macro function close)

=1 :User Parameter

=2 :Compressor

=3 :Fan

=4 :Pump

=5~9 :Reserve

=10 :AHU

2. After selecting application · Pr.13-01~99 will display the related parameters (it will have a little number of parameters different according to the different kind of application list you select. There are 24 default parameters in compressor application; if you select Fan application, there are 33 default parameters.)

3. For example, if you select Compressor application:

13-00=2 (Compressor)

13-01~13-24 (Compressor related parameters)



4. The showing in Application Selection List is Compressor

List PrNum=024(Compressor related parameters)



Compressor			
No.	Pr.	Explanation	Settings
1	00-11	Control of Speed Mode	System Definition
2	00-16	Load Selection	System Definition
3	00-17	Carrier Frequency	Factory Setting
4	00-20	Source of Master Frequency Command (AUTO)	System Definition
5	00-21	Source of the Operation Command (AUTO)	System Definition
6	00-22	Stop Method	System Definition
7	00-23	Control of Motor Direction	System Definition
8	01-00	Max. Operation Frequency	Factory Setting
9	01-01	Output Frequency of Motor 1	Factory Setting

10	01-02	Output Voltage of Motor 1	Factory Setting
11	01-03	Mid-point Frequency 1 of Motor 1	Factory Setting
12	01-04	Mid-point Voltage 1 of Motor 1	Factory Setting
13	01-05	Mid-point Frequency 2 of Motor 1	Factory Setting
14	01-06	Mid-point Voltage 2 of Motor 1	Factory Setting
15	01-07	Min. Output Frequency of Motor 1	Factory Setting
16	01-08	Min. Output Voltage of Motor 1	Factory Setting
17	01-11	Output Frequency Lower Limit	System Definition
18	01-12	Accel. Time 1	System Definition
19	01-13	Decel Time 1	System Definition
20	03-00	Analog Input Selection (AVI)	System Definition
21	03-01	Analog Input Selection (ACI)	System Definition
22	05-01	Full-load Current of Induction Motor 1(A)	Factory Setting
23	05-03	Rated Speed of Induction Motor 1 (rpm)	Factory Setting
24	05-04	Pole Number of Induction Motor 1	Factory Setting

5. When user select" Application Selection List" (e.g. Compressor), drive will show the related parameters in above table according to user 's selection, the settings content can be divided into"System Definition" and"Factory Setting". "System Definition"means drive will load the commonly used value settings in compressor application;"Factory Setting"means the default setting of drive. User can edit the parameter value no matter the setting is"System Definition" or"Factory Setting".
6. User can edit or change the parameter space(max. to 99,Pr.13-01~99) for Compressor in" Application Selection List",if you want to add 2 spaces after default parameter(Pr.13-01~24) for Compressor,it needs to select No.25 & 26 parameter space(Pr.13-25 and Pr.13-26) then enter 7.11(Pr.07-11) and 7.33(Pr.07-33) separately (Please pay a special attention,if you key in 0.00 in any position, it will be identified as the final parameters of this application parameter) · after changing the Application Selection List will have 26 parameter locations for Compressor can be selected.

No.	Pr.	Explanation	Setting
25	07-11	Number of Times of Auto Restart After Fault	System Definition
26	07-33	Auto restart interval of Fault	System Definition
-	00-00	Application Parameters 27 by Industry	-

Please follow the setting process below to set the User Defined application selection (Pr.13-00=1):

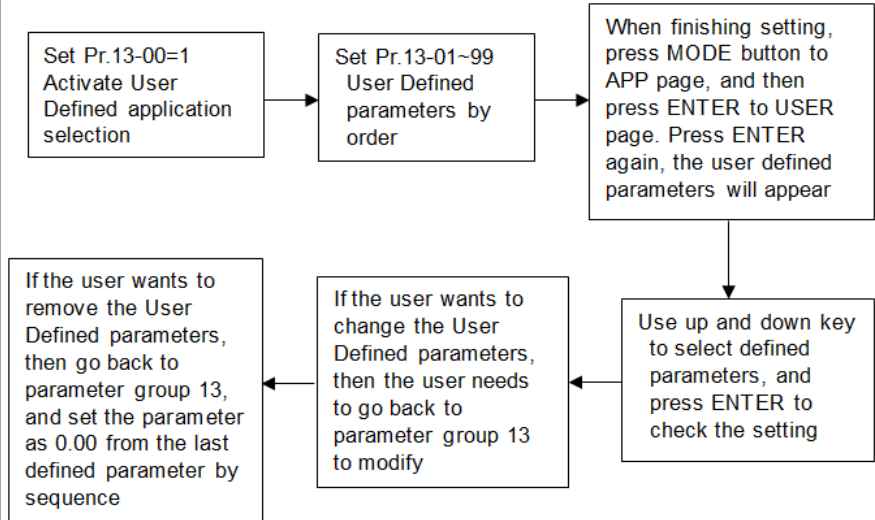

If user select User Parameter (Pr.13-00=1), but there is no any definition for parameter location (Pr.13-01~99), it is not allow to check in Application Selection List page, but also cannot enter next page when press ENTER. If there is User Parameter settings, when back to Application Selection List page, press ENTER it will display the current application as " User Parameter ", then press ENTER again, it will appear the previous setting parameters.





Example : Select Fan Application

	<p>In Pr. Setup page · use▲▼ key to select 13 : Application Selection List · then press .</p>
	<p>Use ▲▼ key to select 00 : Application Selection List · then press .</p>
	<p>It is showing 13-00 parameter value=0(no function) ,use ▲▼ key to adjust the number to 3: Fan · then press to load the relevant parameters of the fan application.</p>
	<p>Back to main page · use ▲▼ key to select 14 : Application Selection List · then press .</p>

App Sel List
Fan
List PrNum =033

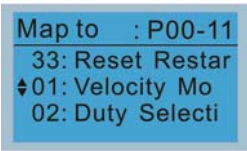

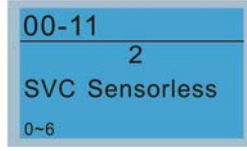

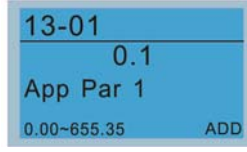
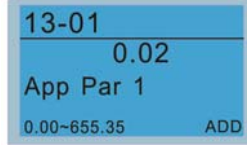

It shows there are 33 default parameters setting in fan application · then press .

Fan			
No.	Pr.	Explanation	Settings
1	00-11	Control of Speed Mode	System Definition
2	00-16	Load Selection	System Definition
3	00-17	Carrier Frequency	Factory Setting
4	00-20	Source of Master Frequency Command (AUTO)	System Definition
5	00-21	Source of the Operation Command (AUTO)	System Definition
6	00-22	Stop Method	System Definition
7	00-23	Control of Motor Direction	System Definition
8	00-30	Source of the Master Frequency Command (HAND)	System Definition
9	00-31	Source of the Operation Command (HAND)	System Definition
10	01-00	Max. Operation Frequency	Factory Setting
11	01-01	Output Frequency of Motor 1	Factory Setting
12	01-02	Output Voltage of Motor 1	Factory Setting
13	01-03	Mid-point Frequency 1 of Motor 1	Factory Setting
14	01-04	Mid-point Voltage 1 of Motor 1	Factory Setting
15	01-05	Mid-point Frequency 2 of Motor 1	Factory Setting
16	01-06	Mid-point Voltage 2 of Motor 1	Factory Setting
17	01-07	Min. Output Frequency of Motor 1	Factory Setting
18	01-08	Min. Output Voltage of Motor 1	Factory Setting
19	01-10	Output Frequency Upper Limit	System Definition
20	01-11	Output Frequency Lower Limit	System Definition
21	01-12	Accel. Time 1	System Definition
22	01-13	Decel Time 1	System Definition
23	01-43	V/F Curve Selection	System Definition
24	02-05	Multi-function Input Command 5 (MI5)	System Definition
25	03-00	Analog Input Selection (AVI)	System Definition
26	03-01	Analog Input Selection (ACI)	System Definition
27	03-28	AVI1 Selection	System Definition
28	03-29	ACI Selection	System Definition
29	03-31	AFM2 Output Selection	System Definition
30	03-50	Analog Input Curve Selection	System Definition
31	07-06	Restart after Momentary Power Loss	System Definition
32	07-11	Number of Times of Auto Restart After Fault	System Definition
33	07-33	Auto restart internal of Fault	System Definition

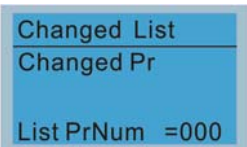
	<p>Use▲▼ key to select parameter from 01~33 · after selecting the parameter you want to change(e.g. 01 : Control of Speed Mode) · then press ENTER.</p>
	<p>It is showing 00-11 parameter value=0(VF(IM V/F control)) ,use▲▼ key to adjust the number to 2 SVC(IM/PM Sensorless vector control) · then press ENTER , it will change to SVC control.</p>
	
<p>There are 33 parameters in fan application · if you want to adjust or add parameters · please select Pr. 13-01~33 for parameter adjustment; or select Pr. 13-34~99 for new parameter setting in parameter group 13. e.g. adjust 13-01 Application Parameter 1 value from 0.11(00-11 Control of Speed Mode) to 0.02(00-02 Parameter Reset).</p>	
	
	<p>Use▲▼ key to select 01 : Application Parameter 1 · then press ENTER to adjust parameter value.</p>
	<p>Use▲▼ key to adjust the parameter 0.02 · then press ENTER.</p>
<ul style="list-style-type: none"> ● In Fan application, when adding new parameter space (Pr.13-34~99) · it needs to pay attention that if you key in 0.00 in any position, it will be identified as the final parameters of this application parameter. ● In addition, whether the user has edited or changed the Application Selection List, when switching to other application, it will load the initial value of this application definition. ● Application Selection List needs to set in parameter group 13.Set Pr.13-00≠0, the Application Selection List is enable. ● Set Pr.13-00=1, User Parameter is enable. ● User sets parameter Pr.13-01 ~ 99 according to the function demand, when the value is 0.00, it means there is no preset or user defined 	

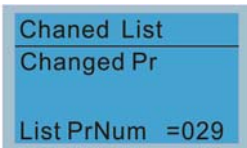
	<p>parameters. Select the desired parameter location then press ENTER, the settings will record to parameters Pr.13-01 ~ 99.</p> <ul style="list-style-type: none"> ● The settings of user parameter is the same as general parameter, use the up /down, left and right keys to speed up the setting, please note that the read-only parameters can not be set. ● If the changed parameter settings need to change again, it needs to back Pr.13-01~99 for modification. ● If you want to remove the parameter when the parameter has been set, you must to remove from the last parameter. For example, if you set 5 parameters from Pr.13-01 to Pr.13-05, if you want to remove Pr.13-02; it needs to remove from Pr.13-05, Pr.13-04 and Pr.13-03 in order.
--	--

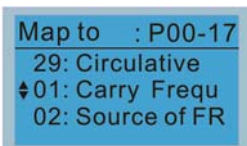
15. Parameter Changed List

 <p>User can review Changed List to check the parameter that is different from default setting.</p>	<p>Parameter changed list will record the parameter change from user (not limited in parameter setting record list)</p>	
		<p>In Menu page · use ▲▼ key to select 15 : Changed List · then press .</p>
		<p>It will show the parameter change history · there are total 29 records change parameters · then press .</p>
		<p>Use ▲▼ key to check and review parameter 01~29 · after selecting the parameter you want to change (e.g. 01 : Carrier Frequency) · then press  · you can change the value of parameter directly.</p>

Other display

When fault occurs, the menu will display:

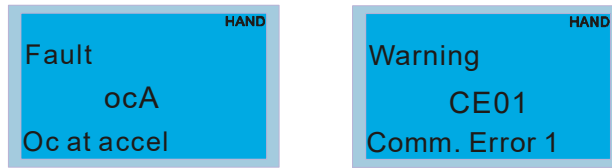

1. Press STOP/RESET button to reset the fault code. If still no response, please contact local distributor or return to the factory. To view the fault DC BUS voltage, output current and output voltage, press “MENU”→“Fault Record”.
2. After resetting, if the screen returns to main page and shows no fault after pressing ESC, the fault is clear.
3. When fault or warning message appears, backlight LED will blink until the fault or the warning is cleared.

Optional accessory: RJ45 Extension Lead for Digital Keypad

Part No.	Description
CBC-K3FT	RJ45 extension lead, 3 feet (approximately 0.9m)
CBC-K5FT	RJ45 extension lead, 5 feet (approximately 1.5 m)
CBC-K7FT	RJ45 extension lead, 7 feet (approximately 2.1 m)
CBC-K10FT	RJ45 extension lead, 10 feet (approximately 3 m)
CBC-K16FT	RJ45 extension lead, 16 feet (approximately 4.9 m)

Note: When you need to buy communication cables, buy non-shielded, 24 AWG, 4 twisted pair, 100 ohms communication cables.

10-3 TPEditor Installation Instruction

TPEditor can edit up to 256 HMI (Human-Machine Interface) pages with a total storage capacity of 256KB. Each page can edit 50 normal objects and 10 communication objects.

- 1) TPEditor: Setup & Basic Functions
 1. Run TPEditor version 1.60 or above

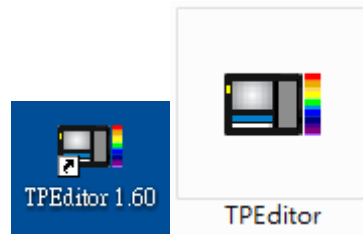

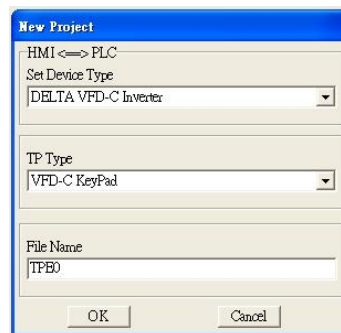

2. Go to File (F) → Click on New. The Window below will pop up. At the device type, click on the drop down menu and choose DELTA VFD-C Inverter. At the TP type, click on the drop down menu and choose VFD-C Keypad. As for File Name, enter TPE0. Now click on OK.



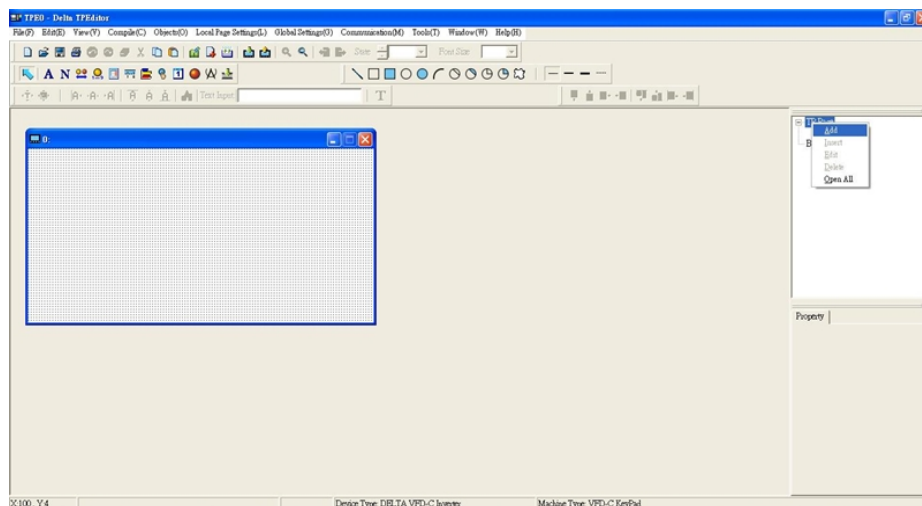

3. You are now at the designing page. Go to Edit (E) → Click on Add a New Page (A) or go to the TP page on the upper right side, right click once on TP page and choose Add to increase one more page for editing.

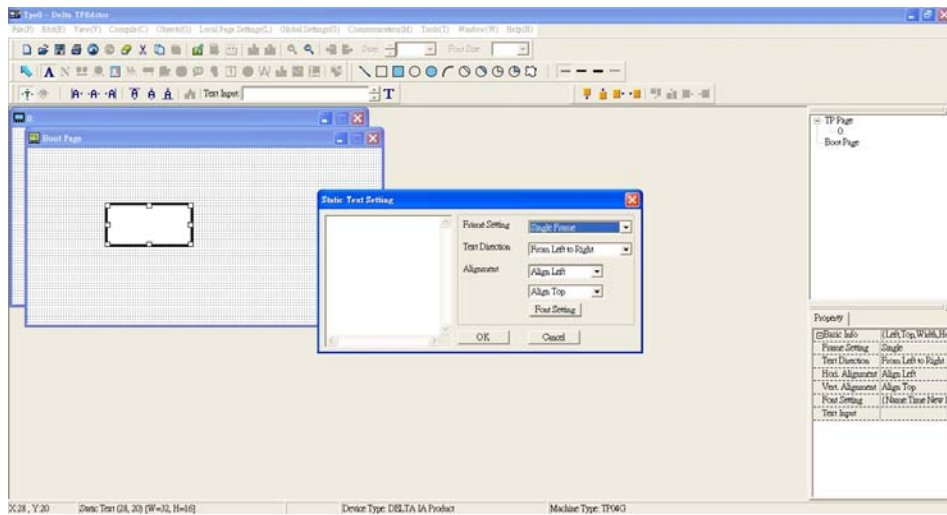

4. Edit Startup Page

5. Static Text . Open a blank page, click once on this button , and then double click on that blank page. The following windows will pop up.



6. Static Bitmap  → Open a blank page, then click once on this button  and then double click on that blank page. The following window will pop up.

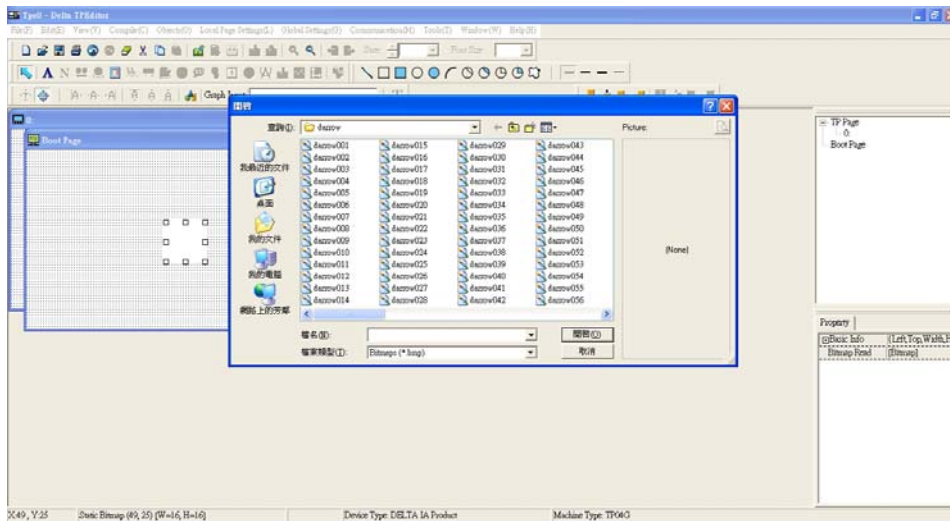

Please note that Static Bitmap setting support only images in BMP format. Now choose an image that you need and click open, then that image will appear in the Static Bitmap window.

7. Geometric Bitmap  → As shown in the picture on the left side, there are 11 kinds of geometric bitmap to choose. Open a new blank page then click once on a geometric bitmap icon that you need. Then drag that icon and enlarge it to the size that you need on that blank page.

- Finish editing the keypad starting screen and select **Communication>Input User Defined Keypad Starting Screen**.

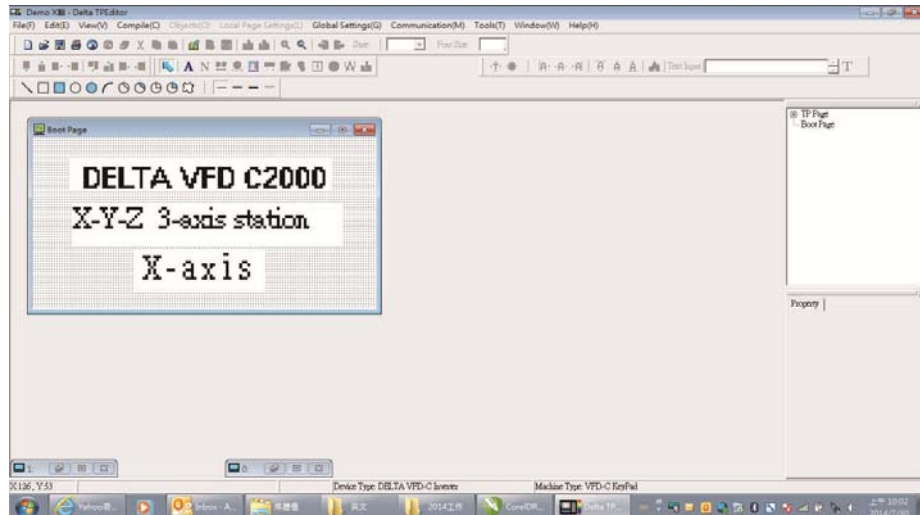

- Download setting: Go to Tool > Communication. Set up communication port and speed of IFD6530. There are five speed selections available: 9600bps 、 19200bps 、 38400bps 、 57600bps and 115200bps.
- Select: Communication > Input User Defined Keypad Starting Screen

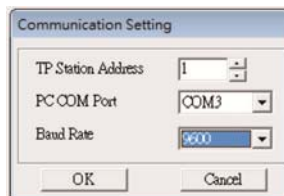

- When a dialogue box displayed on the screen asking to confirm writing or not, press buttons on the keypad to go to MENU, select PC LINK and then press ENTER and wait for few seconds. Then select YES on the screen to start downloading.

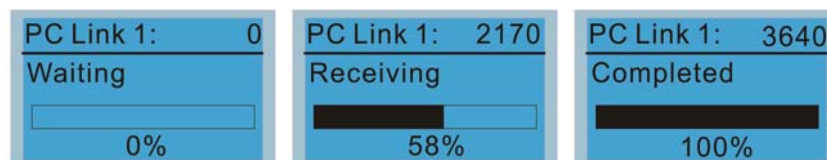
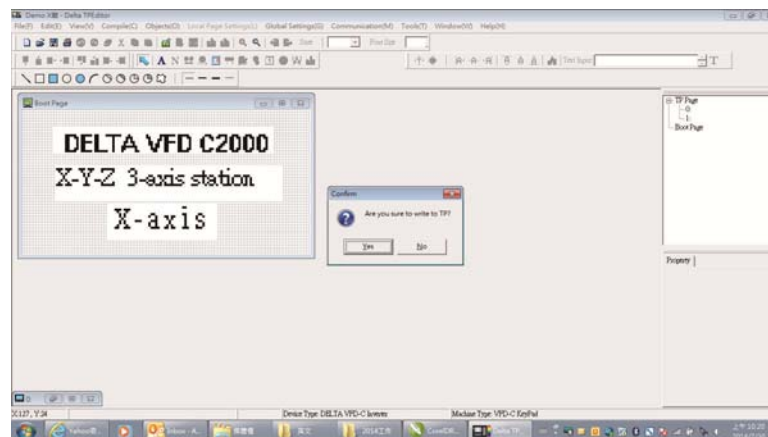

2) Edit Main Page & Example of Download

1. Go to editing page, select add one page or press the button ADD on the right hand side of the HMI page to increase number of pages to edit. This keypad currently support up to 256 pages.

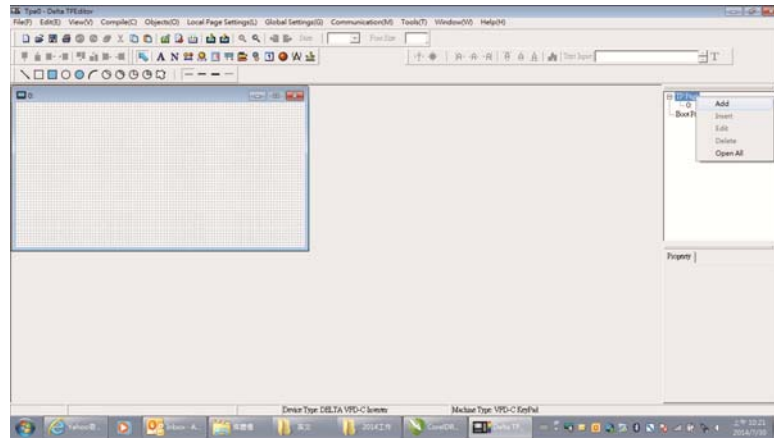

2. On the bottom right-hand corner of the HMI, click on a page number to edit or go to VIEW >HMI page to start editing main page. As shown in the image, the following objects are available. From left to right: Static Text, ASCII Display, Static Bitmap, Scale, Bar Graph, Button, Clock Display, Multi-state bit map, Units, Numeric Input and 11 geometric bitmaps and lines of different width. The application of Static Text, Static Bitmap, and geometric bitmap is the same as the editing startup page.



3. Numeric/ASCII Display: To add a Numeric/ASCII Display object to a screen, double click on the object to set up Related Devices, Frame Setting, Fonts and Alignment.

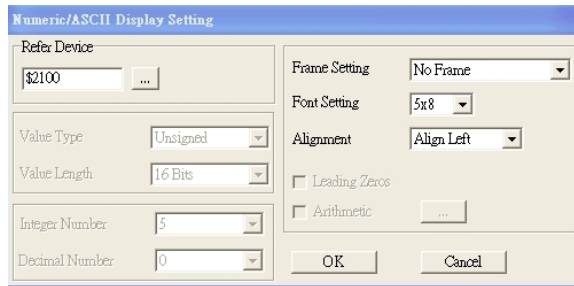

Related Device: Choose the VFD Communication Port that you need, if you want to read output frequency (H), set the VFD Communication Port to \$2202. For other values, please refer to ACMD Modbus Comm Address List.



4. Scale Setting : On the Tool Bar, click on this  for Scale Setting. You can also edit Scale Setting in the Property Window on the right hand side of your computer screen.

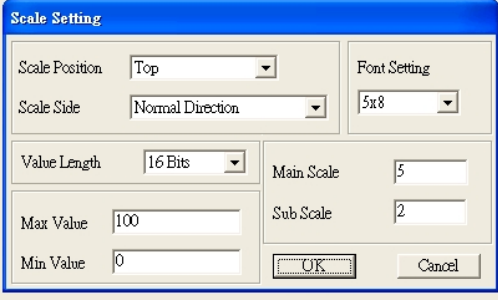



The Scale Setting dialog box contains the following fields and controls:

- Scale Position: Top (dropdown)
- Scale Side: Normal Direction (dropdown)
- Font Setting: 5x8 (dropdown)
- Value Length: 16 Bits (dropdown)
- Main Scale: 5 (text input)
- Sub Scale: 2 (text input)
- Max Value: 100 (text input)
- Min Value: 0 (text input)
- Buttons: OK, Cancel

- Scale Position: Click on the drop down list to choose which position that you need to place a scale.
- Scale Side: Click on the drop down list to choose if you want to number your scale from smaller number to bigger number or from big to small. Click OK to accept this setting or click Cancel to abort.
- Font Setting: Click on the drop down list to choose the Font setting that you need then click OK to accept the setting or click Cancel to abort.
- Value Length: Click on the drop down to choose 16bits or 32 bits. Then click OK to accept the setting or click Cancel to abort.
- Main Scale & Sub Scale: In order to divide the whole scale into equal parts, key in the numbers of your choices for main scale and sub scale.
- Maximum value & Minimum Value are the numbers on the two ends of a scale. They can be negative numbers. But the values allowed to be input are limited by the length of value. For example, when the length of value is set to **be hexadecimal**, the maximum and the minimum value cannot be input as -4000.

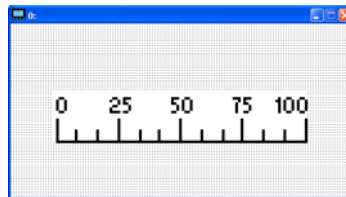
Follow the Scale setting mentioned above; you will have a scale as shown below.



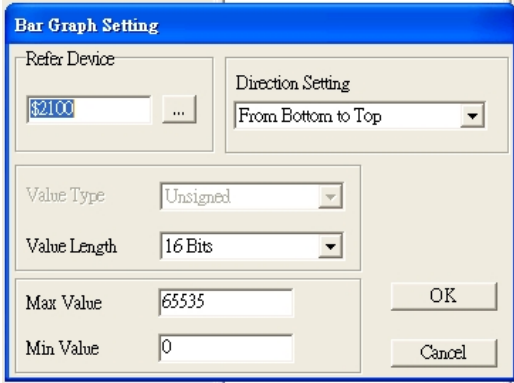

5. Bar Graph setting :



The Bar Graph Setting dialog box contains the following fields and controls:

- Refer Device: \$2100 (text input)
- Direction Setting: From Bottom to Top (dropdown)
- Value Type: Unsigned (dropdown)
- Value Length: 16 Bits (dropdown)
- Max Value: 65535 (text input)
- Min Value: 0 (text input)
- Buttons: OK, Cancel

- Related Device: Choose the VFD Communication Port that you need.
- Direction Setting: Click on the drop down menu to choose one of the following directions: From Bottom to Top, From Top to Bottom, From Left to Right or From Right to Left.
- Maximum Value & Minimum Value: They define the range covered by the maximum value and minimum value. If a value is smaller than or equal to the minimum value, then the bar graph will be blank. If a value is bigger or equal to the maximum value, then the bar graph will be full. If a value is between minimum and maximum value, then the bar graph will be filled proportionally.

6. Button  : Currently this function only allows the Keypad to switch pages, other functions are not yet available. Text input function and Image inserted functions are not yet supported.
 Double click on  to open set up window.

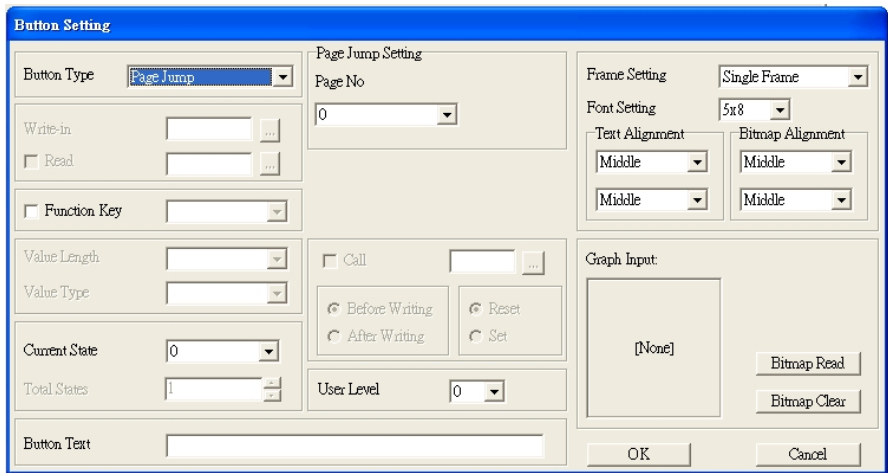

<Button Type> allows users set up buttons' functions. <Page Jump> and <Constant Setting> are the only two currently supported functions.

A [Page Jump] function setting

- Page Jump setting: After you choose the Page Jump function in the drop down list, you will see this Page Jump Setting Menu
- <Function Key> allows you to assign functions to the following keys on the KPC-CC02 keypad: F1, F2, F3, F4, Up, Down, Left and Right. Please note that the Up and Down keys are locked by TPEditor. These two keys cannot be programmed. If you want to program Up and Down keys, go to Tool→Function Key Settings (F) →Re-Define Up/Down Key(R).

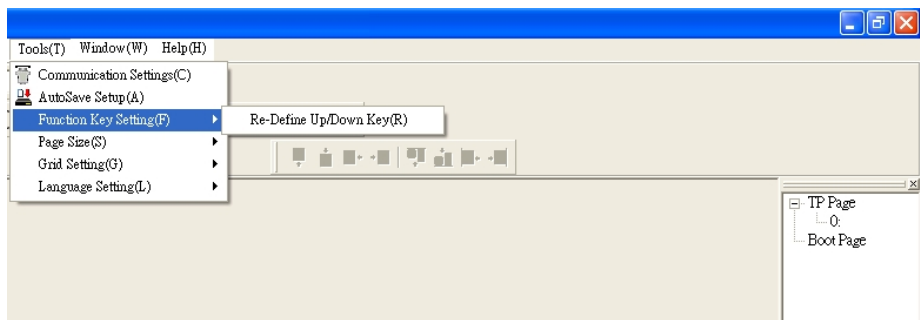

- Button Text: This function allows user to name buttons. For example, key in <Next Page> in the empty space, a button will have the wording <Next Page> displayed on it.

B [Constant setting] function

This function is to set up the memory address' value of the VFD or PLC. When pressing the <function button> set up in before, a value will be written to the memory address of the <Constant Setting>. This function can be used as initializing a variable.

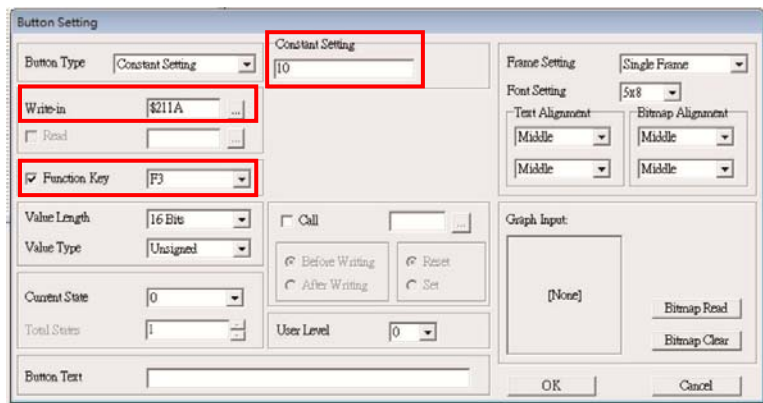

7. Clock Display Setting  : The setup window of the Clock Display is shown as the image below. Time, Day or Date can be displayed on the keypad. Open a new file and click once in that window, you will see the following
In the clock display setting, you can choose to display Time, Day or Date on the Keypad. To adjust time, go to #9 on the Keypad's menu. You can also adjust Frame Setting, Font Setting and Alignment.

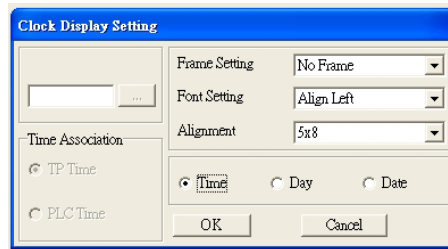

8. Multi-state bitmap  : The setup window of the multi-state is shown as the image below. This object reads the bit's property value of the PLC. It defines what image or wording is when this bit is 0 or when this bit is 1. Set the initial status to be 0 or 1 to define the displayed image or wording.

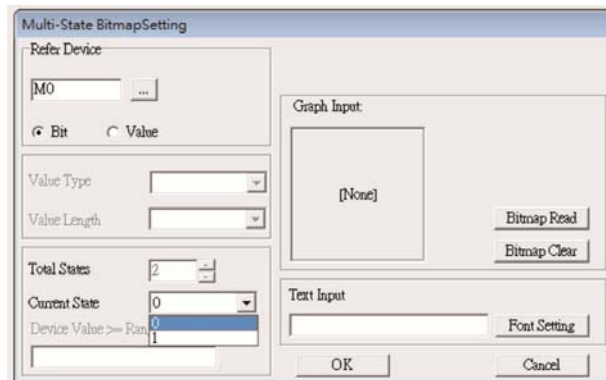

9. Unit Measurement  : Click once on this Button:
Open a new file and double click on that window, you will see the following

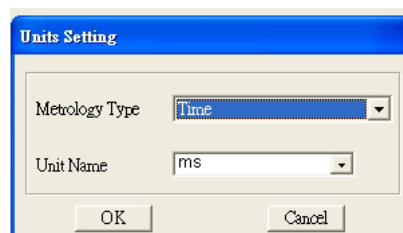

Choose from the drop down list the Metrology and the Unity Name that you need. As for Metrology, you have the following choices Length, Square Measure, Volume/Solid Measure, Weight, Speed, Time and Temperature. The unit name changes automatically when you change metrology type.

10. Numeric Input Setting 

This menu allows you to provide parameters or communication ports and to input numbers.

Click once on this button .

Open a new file and double click on that window, you will see the following:

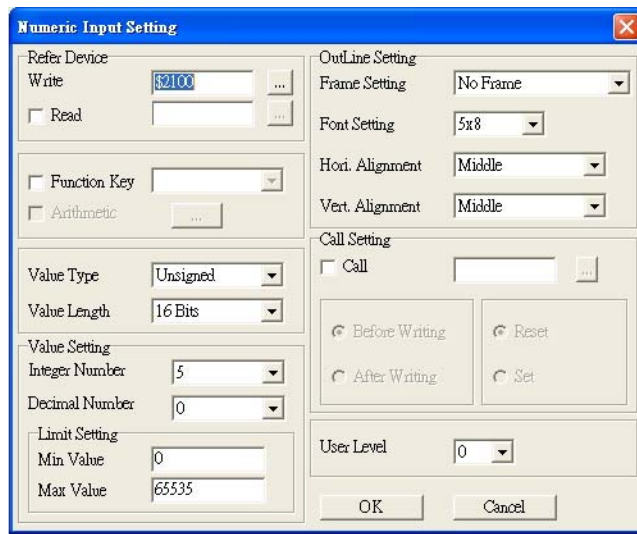

- a. Related Device: There are two blank spaces to fill in, one is <Write> and another one is <Read>. Input the numbers that you want to display and the corresponding numbers of a parameter and that of a communication port. For example, input 012C to Read and Write Parameter P01-44.
- b. Outline Setting: The Frame setting, Font setting, Vertical Alignment and Horizontal Alignment are the same as mentioned before. Click on the drop down menu and choose the setting that you need.
- c. Function key: The setting here allows you to program keys on the keypad. Press the key on the menu then the corresponding key on the keypad will start to blink, then press Enter to confirm the setting.
- d. Value Type & Value Length: These two factors influence the range of the Minimum and Maximum Value of the Limit Setting. Please note that the corresponding supporting values for CFP2000 have to be 16bits. The 32bits values are not supported.
- e. Value Setting: This part is set automatically by the keypad itself.
- f. Limit Setting: Input the range the security setting here.

For example, if you set Function Key as F1, Minimum Value as 0 and Maximum Value is 4, then press F1 on Keypad Then you can press Up and Down key on the keypad to increase or decrease the value. Press Enter Key on the keypad to confirm your setting. You can also go to parameter table 01-44 to verify if you input correctly the value.

- 11. Download TP Page: Press Up or Down key on the keypad until you reach #13 PC Link. Then press Enter on the keypad and you will see the word "Waiting" on keypad's screen. Now choose a page that you have created then go to Communication (M) →Write to TP (W) to start downloading the page to the keypad. When you see the word Completed on the keypad's screen, that means the download is done. Then you can press ESC on the keypad to go back to the menu of the keypad.

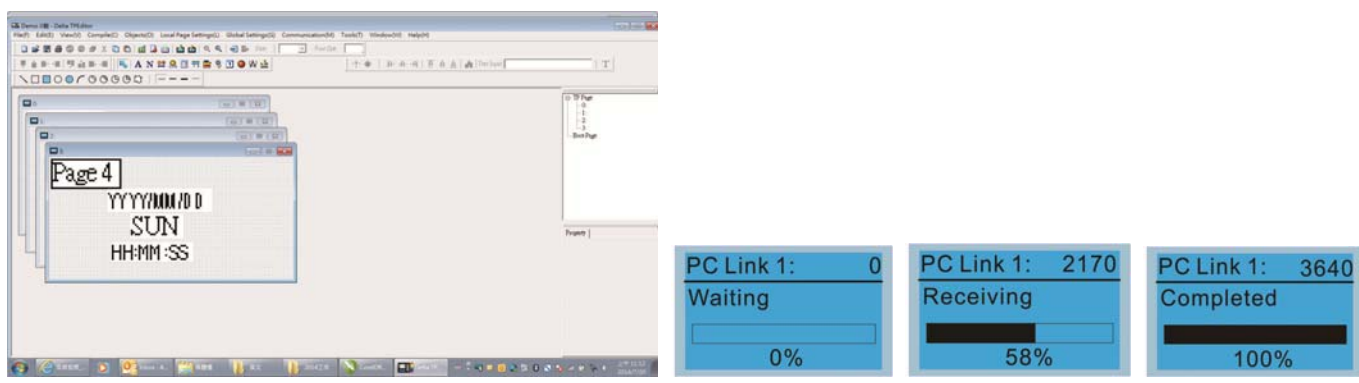

10-4 Digital Keypad KPC-CC02 Fault Codes and Descriptions

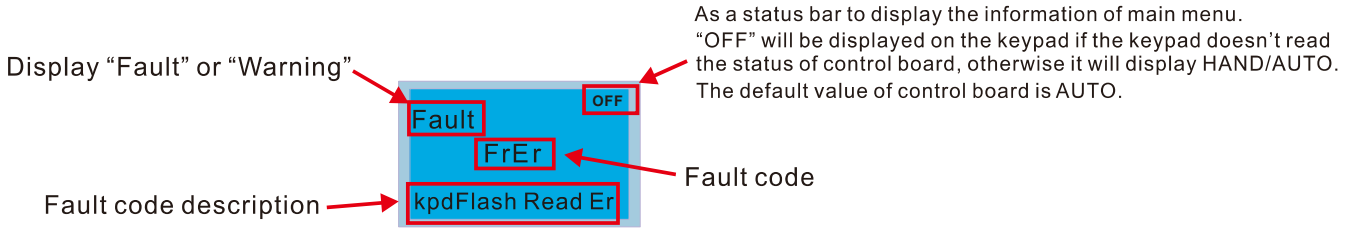

Fault Codes

LCM Display *	Description	Corrective Actions
	Keypad flash memory read error	An error has occurred on keypad's flash memory. 1. Press RESET on the keypad to clear errors. 2. Verify what kind of error has occurred on keypad's flash memory. 3. Shut down the system, wait for ten minutes, and then power on again the system. If none of the solution above works, contact your authorized local dealer.
	Keypad flash memory save error	An error has occurred on keypad's flash memory. 1. Press RESET on the keypad to clear errors. 2. Verify if there's any problem on Flash IC. 3. Shut down the system, wait for ten minutes, and then power on again the system. If none of the solution above works, contact your authorized local dealer.
	Keypad flash memory parameter error	Errors occurred on parameters of factory setting. It might be caused by firmware update. 1. Press RESET on the keypad to clear errors. 2. Verify if there's any problem on Flash IC. 3. Shut down the system, wait for ten minutes, and then power on again the system. If none of the solution above works, contact your local authorized dealer.
	Keypad flash memory when read AC drive data error	Keypad can't read any data sent from VFD. 1. Verify if the keypad is properly connect to the motor drive by a communication cable such as RJ-45. 2. Press RESET on the keypad to clear errors. 3. Shut down the system, wait for ten minutes, and then power on again the system. If none of the solution above works, contact your local authorized dealer.
	And then power on again the system.	A Serious error has occurred on keypad's CPU. 1. Verify if there's any problem on CPU clock? 2. Verify if there's any problem on Flash IC? 3. Verify if there's any problem on RTC IC? 4. Verify if the communication quality of the RS485 is good? 5. Shut down the system, wait for ten minutes, and then power on again the system. If none of the solution above works, contact your local authorized dealer.

Warning Codes

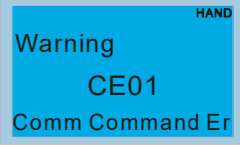
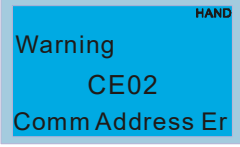
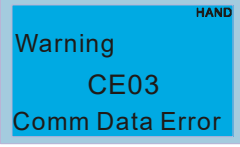
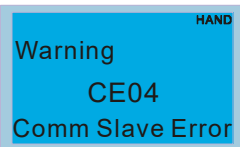
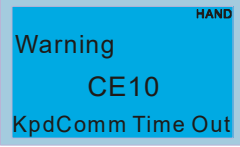
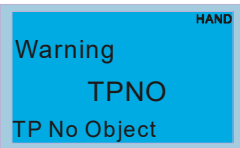
LCM Display *	Description	Corrective Actions
 <p>Warning CE01 Comm Command Er</p>	Modbus function code error	Motor drive doesn't accept the communication command sent from keypad. 1. Verify if the keypad is properly connected to the motor drive on the communication contact by a communication cable such as RJ-45. 2. Press RESET on the keypad to clear errors. If none of the solution above works, contact your local authorized dealer.
 <p>Warning CE02 Comm Address Er</p>	Modbus data address error	Motor drive doesn't accept keypad's communication address. 1. Verify if the keypad is properly connected to the motor drive on the communication contact by a communication cable such as RJ-45. 2. Press RESET on the keypad to clear errors. If none of the solution above works, contact your local authorized dealer.
 <p>Warning CE03 Comm Data Error</p>	Modbus data value error	Motor drive doesn't accept the communication data sent from keypad. 1. Verify if the keypad is properly connected to the motor drive on the communication contact by a communication cable such as RJ-45. 2. Press RESET on the keypad to clear errors. If none of the solution above works, contact your local authorized dealer.
 <p>Warning CE04 Comm Slave Error</p>	Modbus slave drive error	Motor drive cannot process the communication command sent from keypad. 1. Verify if the keypad is properly connected to the motor drive on the communication contact by a communication cable such as RJ-45. 2. Press RESET on the keypad to clear errors. 3. Shut down the system, wait for ten minutes, and then power on again the system. If none of the solution above works, contact your local authorized dealer.
 <p>Warning CE10 KpdComm Time Out</p>	Modbus transmission time-Out	Motor drive doesn't respond to the communication command sent from keypad. 1. Verify if the keypad is properly connected to the motor drive on the communication contact by a communication cable such as RJ-45. 2. Press RESET on the keypad to clear errors. 3. Shut down the system, wait for ten minutes, and then power on again the system. If none of the solution above works, contact your local authorized dealer.
 <p>Warning TPNO TP No Object</p>	Object not supported by TP Editor	Keypad's TP Editor uses unsupported object or Drive series. 1. Verify how the TP Editor should use that object. Delete unsupported object and unsupported setting. 2. Redit the TP editor and then download it. 3. Make sure the Drive series support TP functions. If it didn't, the main page will display default. If none of the solution above works, contact your local authorized dealer.

 **NOTE** The warning code which shows as “CExx” only occurs when the communication problem between the drive and keypad, and it's nothing to do with the drive and other device. Be noted that the warning code description to judge the cause of error if “CExx” occurs.

File Copy Setting Fault Description:

These faults will happen when KPC-CC02 cannot perform the command after clicking the Enter button in copy function.

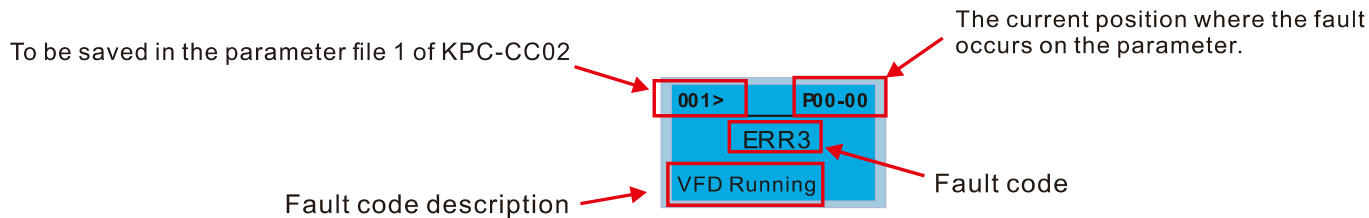

LCM Display *	Description	Corrective Actions
<div style="border: 1px solid black; padding: 5px;"> <div style="display: flex; justify-content: space-between; border-bottom: 1px solid black;"> 001> P00-00 </div> <div style="text-align: center; padding: 5px;"> ERR1 Read Only </div> </div>	Parameter and file are read only	The property of the parameter/file is read-only and cannot be written to. 1. Verify the specification on the user manual. If the solution above doesn't work, contact your local authorized dealer.
<div style="border: 1px solid black; padding: 5px;"> <div style="display: flex; justify-content: space-between; border-bottom: 1px solid black;"> 001> P00-00 </div> <div style="text-align: center; padding: 5px;"> ERR2 Write Fail </div> </div>	Fail to write parameter and file	An error occurred while write to a parameter/file. 1. Verify if there's any problem on the Flash IC. 2. Shut down the system, wait for ten minutes, and then power on again the system. If none of the solution above work, contact your local authorized dealer.
<div style="border: 1px solid black; padding: 5px;"> <div style="display: flex; justify-content: space-between; border-bottom: 1px solid black;"> 001> P00-00 </div> <div style="text-align: center; padding: 5px;"> ERR3 VFD Running </div> </div>	AC drive is in operating status	A setting cannot be made while motor drive is in operation. 1. Verify if the drive is not in operation. If the solution above doesn't work, contact your local authorized dealer.
<div style="border: 1px solid black; padding: 5px;"> <div style="display: flex; justify-content: space-between; border-bottom: 1px solid black;"> 001> P00-00 </div> <div style="text-align: center; padding: 5px;"> ERR4 Pr Lock </div> </div>	AC drive parameter is locked	A setting cannot be made because a parameter is locked. 1. Verify if the parameter is locked or not. If it is locked, unlock it and try to set up the parameter again. If the solution above doesn't work, contact your local authorized dealer.
<div style="border: 1px solid black; padding: 5px;"> <div style="display: flex; justify-content: space-between; border-bottom: 1px solid black;"> 001> P00-00 </div> <div style="text-align: center; padding: 5px;"> ERR5 Pr Changing </div> </div>	AC drive parameter changing	A setting cannot be made because a parameter is being modified. 1. Verify if the parameter is being modified. If it is not being modified, try to set up that parameter again. If the solution above doesn't work, contact your local authorized dealer.
<div style="border: 1px solid black; padding: 5px;"> <div style="display: flex; justify-content: space-between; border-bottom: 1px solid black;"> 001> P00-00 </div> <div style="text-align: center; padding: 5px;"> ERR6 Fault Code </div> </div>	Fault code	A setting cannot be made because an error has occurred on the motor drive. 1. Verify if there's any error occurred on the motor drive. If there isn't any error, try to make the setting again. If the solution above doesn't work, contact your local authorized dealer.
<div style="border: 1px solid black; padding: 5px;"> <div style="display: flex; justify-content: space-between; border-bottom: 1px solid black;"> 001> P00-00 </div> <div style="text-align: center; padding: 5px;"> ERR7 Warning Code </div> </div>	Warning code	A setting cannot be made because of a warning message given to the motor drive. 1. Verify if there's any warning message given to the motor drive. If the solution above doesn't work, contact your local authorized dealer.
<div style="border: 1px solid black; padding: 5px;"> <div style="display: flex; justify-content: space-between; border-bottom: 1px solid black;"> 001> P00-00 </div> <div style="text-align: center; padding: 5px;"> ERR8 Type Dismatch </div> </div>	File type dismatch	Data need to be copied are not same type, so the setting cannot be made. 1. Verify if the products' serial numbers need to be copied fall in the category. If they are in the same category, try to make the setting again. If the solution above doesn't work, contact your authorized dealer.

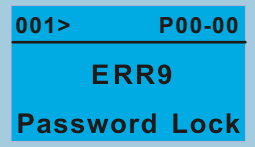
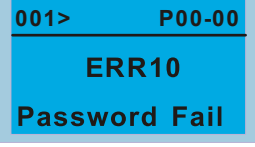
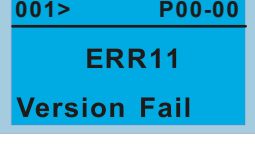
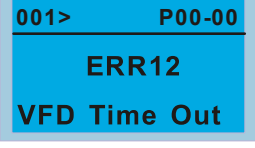
LCM Display *	Description	Corrective Actions
	File is locked with password	A setting cannot be made, because some data are locked. 1. Verify if the data are unlocked or able to be unlocked. If the data are unlocked, try to make the setting again. 2. Shut down the system, wait for ten minutes, and then power on again the system. If none of the solution above works, contact your local authorized dealer.
	File version mismatch	A setting cannot be made because the password is incorrect. 1. Verify if the password is correct. If the password is correct, try to make the setting again. 2. Shut down the system, wait for ten minutes, and then power on again the system. If none of the solution above works, contact your local authorized dealer.
	AC drive copy function time-out	A setting cannot be made, because the version of the data is incorrect. 1. Verify if the version of the data matches the motor drive. If it matches, try to make the setting again. If none of the solution above works, contact your local authorized dealer.
	Other keypad error	A setting cannot be made, because data copying timeout expired. 1. Redo data copying. 2. Verify if copying data is authorized. If it is authorized, try again to copy data. 3. Shut down the system, wait for ten minutes, and then power on again the system. If none of the solution above works, contact your local authorized dealer.

※ The content in this chapter only applies on V1.01 and above of KPC-CC02 keypad.

10-5 Unsupported Functions when using TPEditor on KPC-CC02

1. Local Page Setting and Global Setting functions are not supported.



2. [Communication] → [Read from TP] functions are not supported.

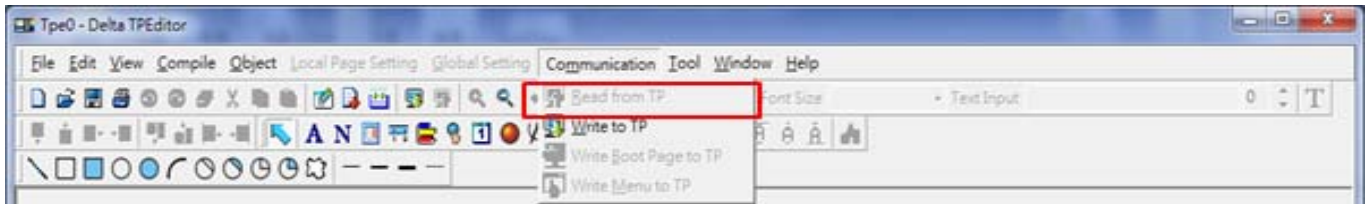

3. In RTC Display Setting, the Refer Device cannot be modified.

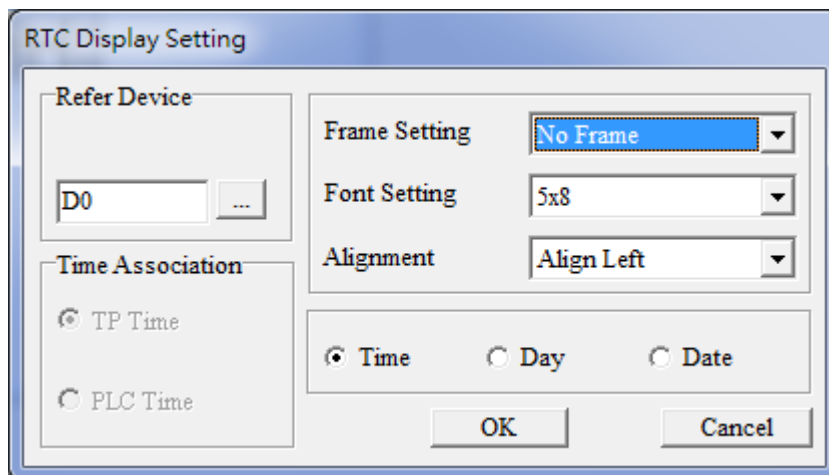

[This page intentionally left blank]



Chapter 11 Summary of Parameter Settings

This chapter provides summary of parameter settings for user to gather the parameter setting ranges, factory settings and set parameters. The parameters can be set, changed and reset by the digital keypad.

NOTE

- 1) : the parameter can be set during operation
- 2) For more detail on parameters, please refer to Ch12 Description of Parameter Settings.

00 Drive Parameters

Pr.	Explanation	Settings	Factory Setting
00-00	Identity Code of the AC Motor Drive	5 : 460V · 1HP (0.75kW) 7 : 460V · 2HP (1.5kW) 9 : 460V · 3HP (2.2kW) 11 : 460V · 5HP (3.7kW) 13 : 460V · 7.5HP (5.5kW) 15 : 460V · 10HP (7.5kW) 17 : 460V · 15HP (11kW) 19 : 460V · 20HP (15kW) 21 : 460V · 25HP (18.5kW) 23 : 460V · 30HP (22kW) 25 : 460V · 40HP (30kW) 27 : 460V · 50HP (37kW) 29 : 460V · 60HP (45kW) 31 : 460V · 75HP (55kW) 33 : 460V · 100HP (75kW) 35 : 460V · 125HP (90kW) 93 : 460V · 5HP (4.0kW)	Read only
00-01	Display AC Motor Drive Rated Current	Display by models	Read only
00-02	Parameter Reset	0: No function 1: Parameter write protect 5: Reset KWH display to 0 6: Reset PLC (including CANopen Master Index) 7: Reset CANopen Index (Slave) 9: All parameters are reset to factory settings(base frequency is 50Hz) 10: All parameters are reset to factory settings (base frequency is 60Hz)	0
 00-03	Start-up Display Selection	0: F (frequency command) 1: H (output frequency) 2: U (multi-function display, see Pr.00-04) 3: A (output current)	0
 00-04	Content of Multi-function Display	0: Display output current (A) (Unit: Amps) 1: Display counter value (c) (Unit: CNT) 2: Display actual output frequency (H.) (Unit: Hz) 3: Display DC-BUS voltage (v) (Unit: Vdc) 4: Display output voltage (E) (Unit: Vac) 5: Display output power angle (n) (Unit: deg) 6: Display output power in kW (P) (Unit: kW) 7: Display actual motor speed rpm (r) (Unit: rpm) 10: Display PID feedback (b) (Unit: %) 11: Display AVI1 in % (1.) (Unit: %) 12: Display ACI in % (2.) (Unit: %) 13: Display AVI2 in % (3.) (Unit: %)	3

Pr.	Explanation	Settings	Factory Setting						
		14: Display the temperature of IGBT in °C (i.) (Unit: °C) 15: Display the temperature of capacitance in °C (c.) (Unit: °C) 16: The status of digital input (ON/OFF) (i) 17: The status of digital output (ON/OFF) (o) 18: Multi-step speed (S) 19: The corresponding CPU pin status of digital input (d) 20: The corresponding CPU pin status of digital output (0.) 25: Overload count (0.00~100.00%) (h.) (Unit: %) 26: Ground Fault GFF(G.) (Unit: %) 27: DC Bus voltage ripple (Unit: Vdc) (r.) 28: Display PLC data D1043 (C) 30: Display output of user defined (U) 31: Display Pr.00-05 user Gain(K) 34: Operation speed of fan (F.) (Unit: %) 36: Present operating carrier frequency of drive (Hz) (J.) 38: Display drive status (6.) 41: KWH display (J) (Unit: kWH) 42: PID Reference (L) (Unit: %) 43: PID offset (o.) (Unit: %) 44: PID Output Fcmd(Hz) (b.) (Unit: Hz) 45: Hardware ID (0)							
↗ 00-05	Coefficient Gain in Actual Output Frequency	0~160.00	1.00						
00-06	Software Version	Read only	Read only						
↗ 00-07	Parameter Protection Password Input	0~65535 0~4: the times of password attempts	0						
↗ 00-08	Parameter Protection Password Setting	0 ~ 65535 0: No password protection / password is entered correctly (Pr00-07) 1: Parameter is locked	0						
00-11	Control of Speed Mode	0: VF (IM V/F control) 2: SVC(IM/PM Sensorless vector control)	0						
↗ 00-16	Duty Selection	0: Light duty 1: Normal duty	0						
00-17	Carrier Frequency	<table border="1"> <tr> <td>1~25HP</td> <td>2~15kHz</td> </tr> <tr> <td>30~100HP</td> <td>2~10kHz</td> </tr> <tr> <td>125HP</td> <td>2~9kHz</td> </tr> </table>	1~25HP	2~15kHz	30~100HP	2~10kHz	125HP	2~9kHz	6
1~25HP	2~15kHz								
30~100HP	2~10kHz								
125HP	2~9kHz								
00-19	PLC Command Mask	Bit 0: Control command by PLC force control Bit 1: Frequency command by PLC force control	0						
00-20	Source of Master Frequency Command (AUTO)	0: Digital keypad 1: RS-485 serial communication 2: External analog input (Pr.03-00) 3: External UP/DOWN terminal 6: CANopen communication card 8: Communication card (no CANopen card)	0						
00-21	Source of the Operation Command (AUTO)	0: Digital keypad 1: External terminals. Keypad STOP disabled. 2: RS-485 serial communication. Keypad STOP disabled. 3: CANopen communication card 5: Communication card (no CANopen card)	0						
↗ 00-22	Stop Method	0: Ramp to stop 1: Coast to stop	0						
↗ 00-23	Control of Motor Direction	0: Enable forward/reverse 1: Reverse disable	0						

Pr.	Explanation	Settings	Factory Setting
		2: Forward disable	
00-24	Memory of Digital Operator (Keypad) Frequency Command	Read only	Read only
00-25	User Defined Characteristics	Bit 0~3: user defined decimal place 0000h --- 0000b: no decimal place 0001h --- 0001b: one decimal place 0002h --- 0010b: two decimal place 0003h --- 0011b: three decimal place Bit 4~15: user define on unit 000xh: Hz 001xh: rpm 002xh: % 003xh: kg 004xh: m/s 005xh: kW 006xh: HP 007xh: ppm 008xh: 1/m 009xh: kg/s 00Axh: kg/m 00Bxh: kg/h 00Cxh: lb/s 00Dxh: lb/m 00Exh: lb/h 00Fhx: ft/s 010xh: ft/m 011xh: m 012xh: ft 013xh: degC 014xh: degF 015xh: mbar 016xh: bar 017xh: Pa 018xh: kPa 019xh: mWG 01Axh: inWG 01Bxh: ftWG 01Cxh: psi 01Dxh: atm 01Exh: L/s 01Fhx: L/m 020xh: L/h 021xh: m ³ /s 022xh: m ³ /h 023xh: GPM 024xh: CFM xxxhx: Hz	0
00-26	Max. User Defined Value	When Pr.00-25 bit 0~3=0000B Setting: 1~65535 0: Disable When Pr.00-25 bit 0~3=0001B Setting: 0.1~6553.5 Factory Setting: 0.0 When Pr.00-25 bit 0~3=0010B Setting: 0.01~655.35 Factory Setting: 0.00 When Pr.00-25 bit 0~3=0011B Setting: 0.001~65.535 Factory Setting: 0.000	0
00-27	User Defined Value	Read only	Read Only

Pr.	Explanation	Settings	Factory Setting
00-28	Switch from AUTO control to HAND (MANUAL) control	bit0: Sleep mode control bit 0: Disable sleep mode 1: Same sleep mode as in AUTO control bit1: Unit displaying control bit 0: Change the displayed unit to Hz 1: Same unit displaying as in AUTO control bit2: PID control bit 0: Disable PID mode 1: Same PID mode as in AUTO control bit3: Source of frequency control bit 0: Source of the frequency depends on the parameter setting. If the multi-speed setting is enabled, the multi-speed has the priority. 1: Source of frequency follows the setting of Pr00-30, regardless the multi-speed setting.	0
00-29	LOCAL/REMOTE Selection	0: Standard HOA function 1: Switching Local/Remote, the drive stops 2: Switching Local/Remote, the drive runs as the REMOTE setting for frequency and operation status 3: Switching Local/Remote, the drive runs as the LOCAL setting for frequency and operation status 4: Switching Local/Remote, the drive runs as LOCAL setting when switch to Local and runs as REMOTE setting when switch to Remote for frequency and operation status.	0
00-30	Source of the Master Frequency Command (HAND)	0: Digital keypad 1: RS-485 serial communication 2: External analog input (Pr.03-00) 3: External UP/DOWN terminal 6: CANopen communication card 8: Communication card (no CANopen card)	0
00-31	Source of the Operation Command (HAND)	0: Digital keypad 1: External terminals. Keypad STOP disabled. 2: RS-485 serial communication. Keypad STOP disabled. 3: CANopen communication card 5: Communication card (not include CANopen card)	0
✓ 00-32	Digital Keypad STOP Function	0: STOP key disable 1: STOP key enable	0
✓ 00-48	Display Filter Time (Current)	0.001~65.535 sec	0.100
✓ 00-49	Display Filter Time (Keypad)	0.001~65.535 sec	0.100
00-50	Software Version (date)	Read only	Read Only

01 Basic Parameters

	Pr.	Explanation	Settings	Factory Setting
✓	01-00	Max. Operation Frequency	50.00~599.00Hz 90kW (125HP): 0.00~400.00Hz	60.00/ 50.00
	01-01	Output Frequency of Motor 1	0.00~599.00Hz	60.00/ 50.00
	01-02	Output Voltage of Motor 1	0.0V~510.0V	400.0
	01-03	Mid-point Frequency 1 of Motor 1	0.00~599.00Hz	3.00
✓	01-04	Mid-point Voltage 1 of Motor 1	0.0V~480.0V	22.0
	01-05	Mid-point Frequency 2 of Motor 1	0.00~599.00Hz	1.50
✓	01-06	Mid-point Voltage 2 of Motor 1	0.0V~480.0V	10.0
	01-07	Min. Output Frequency of Motor 1	0.00~599.00Hz	0.50
✓	01-08	Min. Output Voltage of Motor 1	0.0V~480.0V	2.0
	01-09	Start-Up Frequency	0.00~599.00Hz	0.50
✓	01-10	Output Frequency Upper Limit	0.00~599.00Hz	599.00
✓	01-11	Output Frequency Lower Limit	0.00~599.00Hz	0
✓	01-12	Accel. Time 1	Pr.01-45=0: 0.00~600.00 second Pr.01-45=1: 0.00~6000.0 second	10.00 10.0
✓	01-13	Decel Time 1	Pr.01-45=0: 0.00~600.00 second Pr.01-45=1: 0.00~6000.0 second	10.00 10.0
✓	01-14	Accel Time 2	Pr.01-45=0: 0.00~600.00 second Pr.01-45=1: 0.00~6000.0 second	10.00 10.0
✓	01-15	Decel Time 2	Pr.01-45=0: 0.00~600.00 second Pr.01-45=1: 0.00~6000.0 second	10.00 10.0
✓	01-16	Accel Time 3	Pr.01-45=0: 0.00~600.00 second Pr.01-45=1: 0.00~6000.0 second	10.00 10.0
✓	01-17	Decel Time 3	Pr.01-45=0: 0.00~600.00 second Pr.01-45=1: 0.00~6000.0 second	10.00 10.0
✓	01-18	Accel Time 4	Pr.01-45=0: 0.00~600.00 second Pr.01-45=1: 0.00~6000.0 second	10.00 10.0
✓	01-19	Decel Time 4	Pr.01-45=0: 0.00~600.00 second Pr.01-45=1: 0.00~6000.0 second	10.00 10.0
✓	01-20	JOG Acceleration Time	Pr.01-45=0: 0.00~600.00 second Pr.01-45=1: 0.00~6000.0 second	10.00 10.0
✓	01-21	JOG Deceleration Time	Pr.01-45=0: 0.00~600.00 second Pr.01-45=1: 0.00~6000.0 second	10.00 10.0
✓	01-22	JOG Frequency	0.00~599.00Hz	6.00
✓	01-23	1st/4th Accel/decel Frequency	0.00~599.00Hz	0.00
✓	01-24	S-curve Acceleration Begin Time 1	Pr.01-45=0: 0.00~25.00 second Pr.01-45=1: 0.0~250.0 second	0.20 0.2
✓	01-25	S-curve Acceleration Arrival Time 2	Pr.01-45=0: 0.00~25.00 second Pr.01-45=1: 0.0~250.0 second	0.20 0.2
✓	01-26	S-curve Deceleration Begin Time 1	Pr.01-45=0: 0.00~25.00 second Pr.01-45=1: 0.0~250.0 second	0.20 0.2

Pr.	Explanation	Settings	Factory Setting
↗ 01-27	S-curve Deceleration Arrival Time 2	Pr.01-45=0: 0.00~25.00 second Pr.01-45=1: 0.0~250.0 second	0.20 0.2
01-28	Skip Frequency 1 (upper limit)	0.00~599.00Hz	0.00
01-29	Skip Frequency 1 (lower limit)	0.00~599.00Hz	0.00
01-30	Skip Frequency 2 (upper limit)	0.00~599.00Hz	0.00
01-31	Skip Frequency 2 (lower limit)	0.00~599.00Hz	0.00
01-32	Skip Frequency 3 (upper limit)	0.00~599.00Hz	0.00
01-33	Skip Frequency 3 (lower limit)	0.00~599.00Hz	0.00
01-34	Zero-speed Mode	0: Output waiting 1: Zero-speed operation 2: Fmin (Refer to Pr.01-07, 01-41)	0
01-35	Output Frequency of Motor 2	0.00~599.00Hz	60.00/ 50.00
01-36	Output Voltage of Motor 2	0.0V~510.0V	400.0
01-37	Mid-point Frequency 1 of Motor 2	0.00~599.00Hz	3.00
↗ 01-38	Mid-point Voltage 1 of Motor 2	0.0V~480.0V	22.0
01-39	Mid-point Frequency 2 of Motor 2	0.00~599.00Hz	1.50
↗ 01-40	Mid-point Voltage 2 of Motor 2	0.0V~480.0V	10.0
01-41	Min. Output Frequency of Motor 2	0.00~599.00Hz	0.50
↗ 01-42	Min. Output Voltage of Motor 2	0.0V~480.0V	2.0
01-43	V/F Curve Selection	0: V/F curve determined by Pr.01-00~01-08 1: 1.5 th V/F curve 2: 2 nd V/F curve 3: 60Hz (voltage saturation in 50Hz) 4: 72Hz (voltage saturation in 60Hz) 5: 3 rd decreasing (50Hz) 6: 2 nd decreasing (50Hz) 7: 3 rd decreasing (60Hz) 8: 2 nd decreasing (60Hz) 9: Mid. Starting torque (50Hz) 10: High starting torque (50Hz) 11: Mid. Starting torque (60Hz) 12: High starting torque (60Hz) 13: 90Hz (voltage saturation in 60Hz) 14: 120Hz (voltage saturation in 60Hz) 15: 180Hz (voltage saturation in 60Hz)	0
↗ 01-44	Optimal Acceleration/Deceleration Setting	0: Linear accel. /decel. 1: Auto accel.; linear decel. 2: Linear accel.; auto decel. 3: Auto accel./decel. 4: Linear, stall prevention by auto accel./decel. (limit by Pr.01-12~01-21)	0
01-45	Time Unit for Accel. /Decel. and S Curve	0: Unit: 0.01 sec 1: Unit: 0.1 sec	0
↗ 01-46	CANopen Quick Stop Time	Pr. 01-45=0: 0.00~600.00 sec Pr. 01-45=1: 0.0~6000.0 sec	1.00/ 1.0
01-49	Deceleration Method	0: Normal decel. 1: Over fluxing decel. 2: Traction energy control	0

02 Digital Input/Output Parameters

Pr.	Explanation	Settings	Factory Setting
02-00	2-wire/3-wire Operation Control	0: 2-wire mode 1, power on for operation control 1: 2-wire mode 2, power on for operation control 2: 3-wire, power on for operation control	0
02-01	Multi-function Input Command 1 (MI1)	0: No function	1
02-02	Multi-function Input Command 2 (MI2)	1: Multi-step speed command 1/multi-step position command 1	2
02-03	Multi-function Input Command 3 (MI3)	2: Multi-step speed command 2/multi-step position command 2	3
02-04	Multi-function Input Command 4 (MI4)	3: Multi-step speed command 3/multi-step position command 3	4
02-05	Multi-function Input Command 5 (MI5)	4: Multi-step speed command 4/multi-step position command 4	0
02-06	Multi-function Input Command 6 (MI6)	5: Reset	0
02-07	Multi-function Input Command 7 (MI7)	6: JOG command (By KPC-CC02 or external control)	0
02-08	Multi-function Input Command 8 (MI8)	7: Acceleration/deceleration speed inhibit	0
02-26	Input terminal of I/O extension card (MI10)	8: The 1 st , 2 nd acceleration/deceleration time selection	0
02-27	Input terminal of I/O extension card (MI11)	9: The 3 rd , 4 th acceleration/deceleration time selection	0
02-28	Input terminal of I/O extension card (MI12)	10: EF Input (Pr.07-20)	0
02-29	Input terminal of I/O extension card (MI13)	11: B.B input from external (Base Block)	0
02-30	Input terminal of I/O extension card (MI14)	12: Output stop	0
02-31	Input terminal of I/O extension card (MI15)	13: Cancel the setting of optimal accel. /decel. time	0
		14: Switch between motor 1 and motor 2 15: Operation speed command from AVI1 16: Operation speed command from ACI 17: Operation speed command from AVI2 18: Emergency stop (Pr.07-20) 19: Digital up command 20: Digital down command 21: PID function disabled 22: Clear counter 23: Input the counter value (MI6) 24: FWD JOG command 25: REV JOG command 28: Emergency stop (EF1) 29: Signal confirmation for Y-connection 30: Signal confirmation for Δ-connection 38: Disable EEPROM write function 40: Force coast to stop 41: HAND switch 42: AUTO switch 49: Drive enable 50: Slave dEb action to execute 51: Selection for PLC mode bit0 52: Selection for PLC mode bit1 53: Trigger CANopen quick stop 54: UVW Output Electromagnetic Valve Switch 55: Brake release 56: Local/Remote Selection	

Pr.	Explanation	Settings	Factory Setting
		58: Enable fire mode (with RUN Command) 59: Enable fire mode (without RUN Command) 60: All motors disabled 61: Motor #1 disabled 62: Motor #2 disabled 63: Motor #3 disabled 64: Motor #4 disabled 65: Motor #5 disabled 66: Motor #6 disabled 67: Motor #7 disabled 68: Motor #8 disabled 69: Preheating Command	
↗ 02-09	UP/DOWN key mode	0: up/down by the accel. /decel. time 1: up/down constant speed (Pr.02-10)	0
↗ 02-10	Constant speed. The Accel. /Decel. Speed of the UP/DOWN Key	0.001~1.000Hz/ms	0.001
↗ 02-11	Digital Input Response Time	0.000~30.000 second	0.005
↗ 02-12	Digital Input Mode Selection	0000h~FFFFh (0: N.O.; 1: N.C.)	0000
↗ 02-13	Multi-function Output 1 RY1	0: No function	11
↗ 02-14	Multi-function Output 2 RY2	1: Operation Indication	1
↗ 02-15	Multi-function Output 3 RY3	2: Operation speed attained	66
↗ 02-36	Output terminal of the I/O extension card (MO10 or RA10)	3: Desired frequency attained 1 (Pr.02-22)	0
↗ 02-37	Output Terminal of I/O Extension Card (MO11 or RA11)	4: Desired frequency attained 2 (Pr.02-24)	0
↗ 02-38	Output Terminal of I/O Extension Card (MO12 or RA12)	5: Zero speed (Frequency command)	0
↗ 02-39	Output Terminal of I/O Extension Card (MO13 or RA13)	6: Zero speed, include STOP(Frequency command)	0
↗ 02-40	Output Terminal of I/O Extension Card (MO14 or RA14)	7: Over torque 1 (Pr.06-06~06-08)	0
↗ 02-41	Output Terminal of I/O Extension Card (MO15 or RA15)	8: Over torque 2 (Pr.06-09~06-11)	0
↗ 02-42	Output Terminal of I/O Extension Card (MO16)	9: Drive is ready	0
↗ 02-43	Output Terminal of I/O Extension Card (MO17)	10: Low voltage warning (LV) (Pr.06-00)	0
↗ 02-44	Output Terminal of I/O Extension Card (MO18)	11: Malfunction indication	0
↗ 02-45	Output Terminal of I/O Extension Card (MO19)	12: Mechanical brake release(Pr.02-32)	0
↗ 02-46	Output Terminal of I/O Extension Card (MO20)	13: Overheat warning (Pr.06-15, OH1, OH2)	0
↗		14: Software brake signal indication(Pr.07-00) 15: PID feedback error 16: Slip error (oSL) 17: Terminal count value attained, does not return to 0 (Pr.02-20) 18: Preliminary count value attained, returns to 0 (Pr.02-19) 19: Base Block 20: Warning output 21: Over voltage warning 22: Over-current stall prevention warning 23: Over-voltage stall prevention warning 24: Operation mode indication	

Pr.	Explanation	Settings	Factory Setting	
		25: Forward command 26: Reverse command 27: Output when current \geq Pr.02-33 28: Output when current $<$ Pr.02-33 29: Output when frequency \geq Pr.02-34 30: Output when frequency $<$ Pr.02-34 31: Y-connection for the motor coil 32: Δ -connection for the motor coil 33: Zero speed (actual output frequency) 34: Zero speed include stop(actual output frequency) 35: Error output selection 1(Pr.06-23) 36: Error output selection 2(Pr.06-24) 37: Error output selection 3(Pr.06-25) 38: Error output selection 4(Pr.06-26) 40: Speed attained (including Stop) 44: Low current output (use with Pr.06-71~06-73) 45: UVW Output Electromagnetic valve Switch 46: Master dEb warning output 47: Closed brake output 50: Output for CANopen control 51: Output for RS485 52: Output for communication card 53: Fire mode indication 54: Bypass fire mode indication 55: Motor #1 Output 56: Motor #2 Output 57: Motor #3 Output 58: Motor #4 Output 59: Motor #5 Output 60: Motor #6 Output 61: Motor #7 Output 62: Motor #8 Output 66: STO Logic A Output (Pr02-15) 67: Analog input signal level achieved 68: STO Logic B Output (Pr02-15) 69: Preheating Output Indication		
✓ 02-18	Multi-function output direction	0000h~FFFFh (0: N.O.; 1: N.C.)	0000	
✓ 02-19	Terminal counting value attained (returns to 0)	0~65500	0	
✓ 02-20	Preliminary counting value attained (not return to 0)	0~65500	0	
✓ 02-22	Desired Frequency Attained 1	0.00~599.00Hz	60.00/ 50.00	
✓ 02-23	The Width of the Desired Frequency Attained 1	0.00~599.00Hz	2.00	
✓ 02-24	Desired Frequency Attained 2	0.00~599.00Hz	60.00/ 50.00	
✓ 02-25	The Width of the Desired Frequency Attained 2	0.00~599.00Hz	2.00	
	02-32	Brake Delay Time	0.000~65.000 sec.	0.000
✓ 02-33	Output Current Level Setting for Multi-function External Terminals	0.00~150%	0	
✓ 02-34	Output frequency setting for multi-function output terminal	0.00~599.00Hz	3.00	
✓ 02-35	External Operation Control Selection after Reset and Activate	0: Disable 1: Drive runs if run command exists after reset	0	
	02-50	Status of Multi-function Input Terminal	Monitor the status of multi-function input terminals	Read only

Pr.	Explanation	Settings	Factory Setting
02-51	Status of Multi-function Output Terminal	Monitor the status of multi-function output terminals	Read only
02-52	Display External Output terminal occupied by PLC	Monitor the status of PLC input terminals	Read only
02-53	Display External Multi-function Output Terminal occupied by PLC	Monitor the status of PLC output terminals	Read only
02-54	Display the Frequency Command Executed by External Terminal	0.00~599.00Hz (Read only)	Read only
02-70	IO Expansion Card ID Parameter	0~7	Read only
02-72	Preheating Output Current Level	0~100%	0
02-73	Preheating Output Cycle	0~100%	0

03 Analog Input/Output Parameters

Pr.	Explanation	Settings	Factory Setting
✓ 03-00	Analog Input Selection (AVI1)	0: No function	1
✓ 03-01	Analog Input Selection (ACI)	1: Frequency command (speed limit under torque control mode)	0
✓ 03-02	Analog Input Selection (AVI2)	4: PID target value	0
		5: PID feedback signal 6: PTC thermistor input value 11: PT100 thermistor input value 13: PID Bias Value	
✓ 03-03	Analog Input Bias (AVI1)	-100.0~100.0%	0
✓ 03-04	Analog Input Bias (ACI)	-100.0~100.0%	0
✓ 03-05	Analog Input Bias (AVI2)	-100.0~100.0%	0
✓ 03-07	Positive/negative Bias Mode (AVI1)	0: No bias	0
✓ 03-08	Positive/negative Bias Mode (ACI)	1: Lower than or equal to bias 2: Greater than or equal to bias	
✓ 03-09	Positive/negative Bias Mode (AVI2)	3: The absolute value of the bias voltage while serving as the center 4: Serve bias as the center	
03-10	Analog Frequency Command for Reverse Run	0: Negative frequency is not valid. Forward and reverse run is controlled by digital keypad or external terminal. 1: Negative frequency is valid. Positive frequency = forward run; negative frequency = reverse run. Direction can not be switched by digital keypad or external terminal control.	0
✓ 03-11	Analog Input Gain (AVI1)	-500.0~500.0%	100.0
✓ 03-12	Analog Input Gain (ACI)	-500.0~500.0%	100.0
✓ 03-13	Analog Positive Input Gain 1 (AVI2)	-500.0~500.0%	100.0
✓ 03-14	Analog Negative Input Gain 2 (AVI2)	-500.0~500.0%	100.0
✓ 03-15	Analog Input Filter Time (AVI1)	0.00~20.00 sec.	0.01
✓ 03-16	Analog Input Filter Time (ACI)	0.00~20.00 sec.	0.01
✓ 03-17	Analog Input Filter Time (AVI2)	0.00~20.00 sec.	0.01
✓ 03-18	Addition Function of the Analog Input	0: Disable (AVI1, ACI, AVI2) 1: Enable	0
03-19	Treatment to 4~20mA Analog Input Signal Loss	0: Disable 1: Continue operation at the last frequency 2: Decelerate to 0Hz 3: Stop immediately and display ACE	0
✓ 03-20	Multi-function Output 1 (AFM1)	0: Output frequency (Hz)	0
✓ 03-23	Multi-function Output 2 (AFM2)	1: Frequency command (Hz)	0
		2: Motor speed (Hz) 3: Output current (rms) 4: Output voltage 5: DC Bus voltage 6: Power factor 7: Power 9: AVI1 10: ACI 11: AVI2	

Pr.	Explanation	Settings	Factory Setting
		20: CANopen analog output 21: RS485 analog output 22: Communication card analog output 23: Constant voltage/current output	
✓ 03-21	Gain of Analog Output 1 (AFM1)	0~500.0%	100.0
✓ 03-22	Analog Output 1 when in REV Direction (AFM1)	0: Absolute output voltage 1: Reverse output 0V; Positive output 0~10V 2: Reverse output 5~0V; Positive output 5~10V	0
✓ 03-24	Gain of Analog Output 2 (AFM2)	0~500.0%	100.0
✓ 03-25	Analog Output 2 when in REV Direction (AFM2)	0: Absolute output voltage 1: Reverse output 0V; Positive output 0~10V 2: Reverse output 5~0V; Positive output 5~10V	0
✓ 03-27	AFM2 Output Bias	-100.00~100.00%	0.00
✓ 03-28	AVI1 Selection	0: 0~10V 1: 0~20mA 2: 4~20mA	0
✓ 03-29	ACI Selection	0: 4~20mA 1: 0~10V 2: 0~20mA	0
03-30	Status of PLC Output Terminal	Monitor the status of PLC output terminals	Read only
✓ 03-31	AFM2 Output Selection	0: 0~20mA Output 1: 4~20mA Output	0
✓ 03-34	AFM1 Output Selection	0: 0~20mA Output 1: 4~20mA Output	0
✓ 03-32	AFM1 DC Output Setting Level	0.00~100.00%	0.00
✓ 03-33	AFM2 DC Output Setting Level	0.00~100.00%	0.00
✓ 03-35	AFM1 filter output time	0.00~20.00 Seconds	0.01
✓ 03-36	AFM2 filter output time	0.00~20.00 Seconds	0.01
✓ 03-44	MO by source of AI level	0: AVI1 1: ACI 2: AVI2	0
✓ 03-45	MO output by source of AI upper level	-100.00%~100.00%	50.00%
✓ 03-46	MO output by source of AI lower level	-100.00%~100.00%	10.00%
✓ 03-50	Analog Input Curve Selection	0: Regular Curve 1: 3 point curve of AVI1 2: 3 point curve of ACI 3: 3 point curve of AVI1 & ACI 4: 3 point curve of AVI2 5: 3 point curve of AVI1 & AVI2 6: 3 point curve of ACI & AVI2 7: 3 point curve of AVI1 & ACI & AVI2	7
✓ 03-51	AVI1 Low Point	Pr.03-28=0, 0.00~10.00V Pr.03-28≠0, 0.00~20.00mA	0.00
✓ 03-52	AVI1 Proportional Low Point	-100.00~100.00%	0.00
✓ 03-53	AVI1 Mid Point	Pr.03-28=0, 0.00~10.00V Pr.03-28≠0, 0.00~20.00mA	5.00
✓ 03-54	AVI1 Proportional Mid Point	-100.00~100.00%	50.00
✓ 03-55	AVI1 High Point	Pr.03-28=0, 0.00~10.00V Pr.03-28≠0, 0.00~20.00mA	10.00

	Pr.	Explanation	Settings	Factory Setting
✓	03-56	AVI1 Proportional High Point	-100.00~100.00%	100.00
✓	03-57	ACI Low Point	Pr.03-29=1, 0.00~10.00V Pr.03-29≠1, 0.00~20.00mA	4.00
✓	03-58	ACI Proportional Low Point	-100.00~100.00%	0.00
✓	03-59	ACI Mid Point	Pr.03-29=1, 0.00~10.00V Pr.03-29≠1, 0.00~20.00mA	12.00
✓	03-60	ACI Proportional Mid Point	-100.00~100.00%	50.00
✓	03-61	ACI High Point	Pr.03-29=1, 0.00~10.00V Pr.03-29≠1, 0.00~20.00mA	20.00
✓	03-62	ACI Proportional High Point	-100.00~100.00%	100.00
✓	03-63	Positive AVI2 Voltage Low Point	0.00~10.00V	0.00
✓	03-64	Positive AVI2 Voltage Proportional Low Point	-100.00%~100.00%	0.00
✓	03-65	Positive AVI2 Voltage Mid Point	0.00~10.00V	5.00
✓	03-66	Positive AVI2 Voltage Proportional Mid Point	-100.00%~100.00%	50.00
✓	03-67	Positive AVI2 Voltage High Point	0.00~10.00V	10.00
✓	03-68	Positive AVI2 Voltage Proportional High Point	-100.00%~100.00%	100.00

04 Multi-step Speed Parameters

	Pr.	Explanation	Settings	Factory Setting
✓	04-00	1st Step Speed Frequency	0.00~599.00Hz	0.00
✓	04-01	2nd Step Speed Frequency	0.00~599.00Hz	0.00
✓	04-02	3rd Step Speed Frequency	0.00~599.00Hz	0.00
✓	04-03	4th Step Speed Frequency	0.00~599.00Hz	0.00
✓	04-04	5th Step Speed Frequency	0.00~599.00Hz	0.00
✓	04-05	6th Step Speed Frequency	0.00~599.00Hz	0.00
✓	04-06	7th Step Speed Frequency	0.00~599.00Hz	0.00
✓	04-07	8th Step Speed Frequency	0.00~599.00Hz	0.00
✓	04-08	9th Step Speed Frequency	0.00~599.00Hz	0.00
✓	04-09	10th Step Speed Frequency	0.00~599.00Hz	0.00
✓	04-10	11th Step Speed Frequency	0.00~599.00Hz	0.00
✓	04-11	12th Step Speed Frequency	0.00~599.00Hz	0.00
✓	04-12	13th Step Speed Frequency	0.00~599.00Hz	0.00
✓	04-13	14th Step Speed Frequency	0.00~599.00Hz	0.00
✓	04-14	15th Step Speed Frequency	0.00~599.00Hz	0.00
✓	04-50	PLC buffer 0	0~65535	0
✓	04-51	PLC buffer 1	0~65535	0
✓	04-52	PLC buffer 2	0~65535	0
✓	04-53	PLC buffer 3	0~65535	0
✓	04-54	PLC buffer 4	0~65535	0
✓	04-55	PLC buffer 5	0~65535	0
✓	04-56	PLC buffer 6	0~65535	0
✓	04-57	PLC buffer 7	0~65535	0
✓	04-58	PLC buffer 8	0~65535	0
✓	04-59	PLC buffer 9	0~65535	0
✓	04-60	PLC buffer 10	0~65535	0
✓	04-61	PLC buffer 11	0~65535	0
✓	04-62	PLC buffer 12	0~65535	0
✓	04-63	PLC buffer 13	0~65535	0
✓	04-64	PLC buffer 14	0~65535	0
✓	04-65	PLC buffer 15	0~65535	0
✓	04-66	PLC buffer 16	0~65535	0
✓	04-67	PLC buffer 17	0~65535	0
✓	04-68	PLC buffer 18	0~65535	0
✓	04-69	PLC buffer 19	0~65535	0

05 Motor Parameters

Pr.	Explanation	Settings	Factory Setting
05-00	Motor Auto Tuning	0: No function 1: Rolling test for induction motor (IM) (Rs, Rr, Lm, Lx, no-load current) 2: Static test for induction motor (IM) 5: Dynamic test for PM (SPM) motor 13: Static test for PM (IPM) motor	0
05-01	Full-load Current of Induction Motor 1(A)	Determined by motors power	Determined by motors power
✓ 05-02	Rated Power of Induction Motor 1(kW)	0~655.35kW	#.##
✓ 05-03	Rated Speed of Induction Motor 1 (rpm)	0~65535 1710 (60Hz 4poles); 1410(50Hz 4 poles)	1710
05-04	Pole Number of Induction Motor 1	2~64	4
05-05	No-load Current of Induction Motor 1 (A)	0~Pr.05-01 factory setting	#.##
05-06	Stator Resistance (Rs) of Induction Motor 1	0.000~65.535Ω	#####
05-07	Rotor Resistance (Rr) of Induction Motor 1	0.000~65.535Ω	#####
05-08	Magnetizing Inductance (Lm) of Induction Motor 1	0~6553.5mH	##
05-09	Stator Inductance (Lx) of Induction Motor 1	0~6553.5mH	##
05-13	Full-load Current of Induction Motor 2 (A)	Determined by motors power	Determined by motors power
✓ 05-14	Rated Power of Induction Motor 2 (kW)	0~655.35kW	#.##
✓ 05-15	Rated Speed of Induction Motor 2 (rpm)	0~65535 1710(60Hz 4 poles); 1410(50Hz 4 poles)	1710
05-16	Pole Number of Induction Motor 2	2~64	4
05-17	No-load Current of Induction Motor 2 (A)	0~ Pr.05-13 factory setting	#.##
05-18	Stator Resistance (Rs) of Induction Motor 2	0.000~65.535Ω	#####
05-19	Rotor Resistance (Rr) of Induction Motor 2	0.000~65.535Ω	#####
05-20	Magnetizing Inductance (Lm) of Induction Motor 2	0.0~6553.5mH	##
05-21	Stator Inductance (Lx) of Induction Motor 2	0.0~6553.5mH	##
05-22	Induction Motor 1/ 2 Selection	1: motor 1 2: motor 2	1
✓ 05-23	Frequency for Y-connection/Δ -connection Switch of Induction Motor	0.00~599.00Hz	60.00
05-24	Y-connection/Δ -connection Switch of Induction Motor	0: Disable 1: Enable	0
05-25	Delay Time for Y-connection/Δ -connection Switch of Induction Motor	0.000~60.000 seconds	0.200
05-28	Motor drive's Accumulated Operating Watt per Hour (W-Hour)	Read only	0.0

Pr.	Explanation	Settings	Factory Setting
05-29	Motor drive's Accumulated Operating Kilowatt per Hour (KW-Hour)	Read only	0.0
05-30	Motor Drive's Accumulated Operating Megawatt per Hour (MW-Hour)	Read only	0.0
05-31	Accumulative Motor Operation Time (Min)	00~1439	0
05-32	Accumulative Motor Operation Time (day)	00~65535	0
05-33	Induction Motor and Permanent Magnet Motor Selection	0: Induction Motor 1: SPM Permanent Magnet Motor 2: IPM Permanent Magnet Motor	0
05-34	Full-load current of Permanent Magnet Motor	0.00~655.35Amps	Determined by motors power
✓ 05-35	Rated Power of Permanent Magnet Motor	0.00~655.35kW	Determined by motors power
✓ 05-36	Rated speed of Permanent Magnet Motor	0~65535rpm	2000
05-37	Pole number of Permanent Magnet Motor	0~65535	10
05-38	Inertia of Permanent Magnet Motor	0.0~6553.5 kg.cm ²	Determined by motors power
05-39	Stator Resistance of PM Motor	0.000~65.535Ω	0.000
05-40	Permanent Magnet Motor Ld	0.00~655.35mH	0.000
05-41	Permanent Magnet Motor Lq	0.00~655.35mH	0.000
✓ 05-42	PM Motor Magnetic Angle	0.0~360.0°	0.0
✓ 05-43	Ke parameter of PM Motor	0~65535 (Unit: V/1000rpm)	0

06 Protection Parameters

	Pr.	Explanation	Settings	Factory Setting
✓	06-00	Low Voltage Level	300.0~440.0VDC	360.0
✓	06-01	Over-voltage Stall Prevention	0.0~900.0VDC	760.0
✓	06-02	Selection for Over-voltage Stall Prevention	0: Traditional over-voltage stall prevention 1: Smart over-voltage prevention	0
✓	06-03	Over-current Stall Prevention during Acceleration	Normal Load: 0~160% (100%: drive's rated current) Light Load: 0~130% (100%: drive's rated current)	120
✓	06-04	Over-current Stall Prevention during Operation	Normal Load: 0~160% (100%: drive's rated current) Light Load: 0~130% (100%: drive's rated current)	120
✓	06-05	Accel. /Decel. Time Selection of Stall Prevention at Constant Speed	0: by current accel/decel time 1: by the 1st accel/decel time 2: by the 2nd accel/decel time 3: by the 3rd accel/decel time 4: by the 4th accel/decel time 5: by auto accel/decel	0
✓	06-06	Over-torque Detection Selection (OT1)	0: No function 1: Continue operation after Over-torque detection during constant speed operation 2: Stop after Over-torque detection during constant speed operation 3: Continue operation after Over-torque detection during RUN 4: Stop after Over-torque detection during RUN	0
✓	06-07	Over-torque Detection Level (OT1)	10~200% (100%: drive's rated current)	120
✓	06-08	Over-torque Detection Time (OT1)	0.0~60.0 sec.	0.1
✓	06-09	Over-torque Detection Selection (OT2)	0: No function 1: Continue operation after Over-torque detection during constant speed operation 2: Stop after Over-torque detection during constant speed operation 3: Continue operation after Over-torque detection during RUN 4: Stop after Over-torque detection during RUN	0
✓	06-10	Over-torque Detection Level (OT2)	10~200% (100%: drive's rated current)	120
✓	06-11	Over-torque Detection Time (OT2)	0.0~60.0 sec.	0.1
✓	06-12	Current Limit	0~200% (100%: drive's rated current)	150
✓	06-13	Electronic Thermal Relay Selection (Motor 1)	0: Inverter motor (with external forced cooling) 1: Standard motor (so motor with fan on the shaft) 2: Disable	2
✓	06-14	Electronic Thermal Characteristic for Motor 1	30.0~600.0 sec.	60.0
✓	06-15	Heat Sink Over-heat (OH1) Warning	0.0~110.0°C	105.0
✓	06-16	Stall Prevention Limit Level	0~100% (Pr.06-03, Pr.06-04)	50
	06-17	Fault Record 1 (Present Fault Record)	0: No fault record	0
	06-18	Fault Record 2	1: Over-current during acceleration (ocA)	0
	06-19	Fault Record 3	2: Over-current during deceleration (ocd)	0
	06-20	Fault Record 4	3: Over-current during constant speed(ocn)	0
	06-21	Fault Record 5	4: Ground fault (GFF)	0
	06-22	Fault Record 6	5: IGBT short-circuit (occ)	0

Pr.	Explanation	Settings	Factory Setting
		6: Over-current at stop (ocS) 7: Over-voltage during acceleration (ovA) 8: Over-voltage during deceleration (ovd) 9: Over-voltage during constant speed (ovn) 10: Over-voltage at stop (ovS) 11: Low-voltage during acceleration (LvA) 12: Low-voltage during deceleration (Lvd) 13: Low-voltage during constant speed (Lvn) 14: Stop mid-low voltage (LvS) 15: Phase loss protection (OrP) 16: IGBT over-heat (oH1) 17: Inner temp. over-heat (oH2) 18: tH1o (TH1 open: IGBT over-heat protection error) 19: tH2o (TH2 open: Inner temp. over-heat protection error) 21: Drive over-load (oL) 22: Electronics thermal relay 1 (EoL1) 23: Electronics thermal relay 2 (EoL2) 24: Motor overheat (oH3) (PTC/PT100) 26: Over-torque 1 (ot1) 27: Over-torque 2 (ot2) 28: Low current (uC) 30: Memory write-in error (cF1) 31: Memory read-out error (cF2) 33: U-phase current detection error (cd1) 34: V-phase current detection error (cd2) 35: W-phase current detection error (cd3) 36: Clamp current detection error (Hd0) 37: Over-current detection error (Hd1) 38: Over-voltage detection error (Hd2) 39: Unusual IGBT short-circuiting (Hd3) 40: Auto tuning error (AUE) 41: PID feedback loss (AFE) 48: Analog current input loss (ACE) 49: External fault input (EF) 50: Emergency stop (EF1) 51: External Base Block (bb) 52: Password error (PcodE) 53: Firmware version error 54: Communication error (cE1) 55: Communication error (cE2) 56: Communication error (cE3) 57: Communication error (cE4) 58: Communication Time-out (cE10) 60: Brake transistor error (bF) 61: Y-connection/ Δ -connection switch error (ydc) 62: Decel. Energy Backup Error (dEb) 63: Slip error (oSL) 64: Electromagnet switch error (ryF) 72: Channel 1 (STO1~SCM1) internal hardware error (STL1) 73: External safety gate (S1) 74: FIRE mode output 76: Safe Torque Off (STO) 77: Channel 2 (STO2~SCM2) internal hardware error (STL2) 78: Channel 1 and Channel 2 internal hardware error (STL3) 79: U phase over current (Uocc) 80: V phase over current (Vocc) 81: W phase over current (Wocc) 82: U phase output phase loss (OPHL)	

Pr.	Explanation	Settings	Factory Setting	
		83: V phase output phase loss (OPHL) 84: W phase output phase loss (OPHL) 90: FStp Inner PLC function is forced to stop 99: TRAP CPU command error 101: CANopen software disconnect1 (CGdE) 102: CANopen software disconnect2 (CHbE) 103: CANopen synchronous error (CSyE) 104: CANopen hardware disconnect (CbFE) 105: CANopen index setting error (CIdE) 106: CANopen slave station number setting error (CAAdE) 107: CANopen index setting exceed limit (CFrE) 111: Internal communication overtime error (ictE)		
✓	06-23	Fault Output Option 1	0~65535 (refer to bit table for fault code)	0
✓	06-24	Fault Output Option 2	0~65535 (refer to bit table for fault code)	0
✓	06-25	Fault Output Option 3	0~65535 (refer to bit table for fault code)	0
✓	06-26	Fault Output Option 4	0~65535 (refer to bit table for fault code)	0
✓	06-27	Electronic Thermal Relay Selection 2 (Motor 2)	0: Inverter motor (with external forced cooling) 1: Standard motor (so motor with fan on the shaft) 2: Disable	2
✓	06-28	Electronic Thermal Characteristic for Motor 2	30.0~600.0 sec	60.0
✓	06-29	PTC Detection Selection	0: Warn and keep operation 1: Warn and ramp to stop 2: Warn and coast to stop 3: No warning	0
✓	06-30	PTC Level	0.0~100.0%	50.0
	06-31	Frequency Command for Malfunction	0.00~599.00Hz	Read only
	06-32	Output Frequency at Malfunction	0.00~599.00Hz	Read only
	06-33	Output Voltage at Malfunction	0.0~6553.5V	Read only
	06-34	DC Voltage at Malfunction	0.0~6553.5V	Read only
	06-35	Output Current at Malfunction	0.00~6553.5 Amp	Read only
	06-36	IGBT Temperature at Malfunction	-3276.7~3276.7°C	Read only
	06-37	Capacitance Temperature at Malfunction	-3276.7~3276.7°C	Read only
	06-38	Motor Speed in rpm at Malfunction	-32767~32767 rpm	Read only
	06-40	Status of Multi-function Input Terminal at Malfunction	0000h~FFFFh	Read only
	06-41	Status of Multi-function Output Terminal at Malfunction	0000h~FFFFh	Read only
	06-42	Drive Status at Malfunction	0000h~FFFFh	Read only
✓	06-44	STO Latch Selection	0: STO alarm Latch 1: STO alarm not Latch	0
✓	06-45	Treatment to Output Phase Loss Detection (OPHL)	0: Warn and keep operation 1: Warn and ramp to stop 2: Warn and coast to stop 3: No warning	3
✓	06-46	Deceleration Time of Output Phase Loss	0~65.535 sec.	0.500

	Pr.	Explanation	Settings	Factory Setting
✓	06-47	Current detection level of output phase loss	0.00~100.00%	1.00
✓	06-48	DC Brake Time of Output Phase Loss	0~65.535 sec.	0.000
✓	06-49	LvX Auto Reset	0: Disable 1: Enable	0
✓	06-50	Time for Input Phase Loss Detection	0.00~600.00 sec.	0.20
✓	06-52	Ripple of Input Phase Loss	0.0~200.0 VDC	60.0
✓	06-53	Treatment for the detected Input Phase Loss (OrP)	0: warn and ramp to stop 1: warn and coast to stop	0
	06-55	Derating Protection	0: constant rated current and limit carrier wave by load current and temperature 1: constant carrier frequency and limit load current by setting carrier wave 2: constant rated current(same as setting 0), but close current limit	0
✓	06-56	PT100 Detected Level 1	0.000~10.000V	5.000
✓	06-57	PT100 Detected Level 2	0.000~10.000V	7.000
✓	06-58	PT100 Level 1 Frequency Protect	0.00~599.00Hz	0.00
✓	06-59	PT100 activation level delay time	0~6000 sec.	60
✓	06-60	Software Detection GFF Current Level	0.0~6553.5 %	60.0
✓	06-61	Software Detection GFF Filter Time	0.00~655.35 sec.	0.10
	06-63	Fault Record 1 (Day)	0~65535 days	Read only
	06-64	Fault Record 1 (Min)	0~1439 min	Read only
	06-65	Fault Record 2 (Day)	0~65535 days	Read only
	06-66	Fault Record 2 (Min)	0~1439 min	Read only
	06-67	Fault Record 3 (Day)	0~65535 days	Read only
	06-68	Fault Record 3 (Min)	0~1439 min	Read only
	06-69	Fault Record 4 (Day)	0~65535 days	Read only
	06-70	Fault Record 4 (Min)	0~1439 min	Read only
✓	06-71	Low Current Setting Level	0.0~100.0 %	0.0
✓	06-72	Low Current Detection Time	0.00~360.00 sec.	0.00
✓	06-73	Treatment for low current	0 : No function 1 : Warn and coast to stop 2 : Warn and ramp to stop by 2nd deceleration time 3 : Warn and operation continue	0
✓	06-76	dEb motion offset setting	0~200.0 VDC	40.0
	06-80	Fire mode	0: No function 1: Forward operation 2: Reverse operation	0
✓	06-81	Operating Frequency when running Fire Mode(Hz)	0.00~599.00Hz	60.00
✓	06-82	Bypass Fire Mode enabled	0: Disable Bypass 1: Enable Bypass	0

Pr.	Explanation	Settings	Factory Setting
✓ 06-84	Auto reset counter of Fire Mode	0~10	0
✓ 06-85	Length of time to reset auto-counter (seconds)	0.0~6000.0 sec.	60.0
06-86	Fire mode motion	Bit0: 0=Open Loop; 1=Close Loop (PID control) Bit1: 0=Manual reset fire mode; 1=Auto reset fire mode 0: Open loop control & manual reset fire mode 1: Close loop control & manual reset fire mode 2: Open loop control & auto reset fire mode 3: Close loop control & auto reset fire mode	0
06-87	Fire mode PID set point	0~100.00% (according to Pr.01-00 Max. operation frequency)	0.0

07 Special Parameters

	Pr.	Explanation	Settings	Factory Setting
✓	07-00	Software Brake Level	700.0~900.0VDC	740.0
✓	07-01	DC Brake Current Level	0~100%	0
✓	07-02	DC Brake Time at RUN	0.0~60.0 sec.	0.0
✓	07-03	DC Brake Time at Stop	0.0~60.0 sec.	0.0
✓	07-04	DC Brake frequency at Stop	0.00~599.00Hz	0.00
✓	07-05	Voltage Increasing Gain	1~200%	100
✓	07-06	Restart after Momentary Power Loss	0: Stop operation 1: Speed search for last frequency command 2: Speed search for minimum output frequency	0
✓	07-07	Maximum Power Loss Duration	0.0~20.0 sec.	2.0
✓	07-08	Base Block Time	0.0~5.0 (Depending on the motor power)	##
✓	07-09	Current Limit for Speed Search	20~200%	100
✓	07-10	Treatment to Restart After Fault	0: Stop operation 1: Speed search starts with current speed 2: Speed search starts with minimum output frequency	0
✓	07-11	Number of Times of Auto Restart After Fault	0~10	0
✓	07-12	Speed Search during Start-up	0: Disable 1: Speed search for maximum output frequency 2: Speed search for start-up motor frequency 3: Speed search for minimum output frequency	0
✓	07-13	dEb Selection	0: Disable 1: dEb with auto accel./decel., the output frequency will not return after power reply. 2: dEb with auto accel./decel., the output frequency will return after power reply.	0
✓	07-15	Dwell Time at Accel.	0.00~600.00 sec.	0.00
✓	07-16	Dwell Frequency at Accel.	0.00~599.00Hz	0.00
✓	07-17	Dwell Time at Decel.	0.00~600.00 sec.	0.00
✓	07-18	Dwell Frequency at Decel.	0.00~599.00Hz	0.00
✓	07-19	Fan Cooling Control	0: Fan always ON 1: 1 minute after the AC motor drive stops, fan will be OFF 2: When the AC motor drive runs, the fan is ON. When the AC motor drive stops, the fan is OFF 3: Fan turns ON when preliminary IGBT temperature (around 60°C) is attained. 4: Fan always OFF	0
✓	07-20	Emergency Stop (EF) & Force to Stop Selection	0: Coast stop 1: By deceleration Time 1 2: By deceleration Time 2 3: By deceleration Time 3 4: By deceleration Time 4 5: System Deceleration 6: Automatic Deceleration	0
✓	07-21	Auto Energy-saving Operation	0: Disable 1: Enable	0
✓	07-22	Energy-saving Gain	10~1000%	100

Pr.	Explanation	Settings	Factory Setting
✎ 07-23	Auto Voltage Regulation(AVR) Function	0: Enable AVR 1: Disable AVR 2: Disable AVR during deceleration	0
✎ 07-24	Filter Time of Torque Compensation (V/F and SVC control mode)	0.001~10.000 sec.	0.500
✎ 07-25	Filter Time of Slip Compensation (V/F and SVC control mode)	0.001~10.000 sec.	0.100
✎ 07-26	Torque Compensation Gain (V/F and SVC control mode)	Induction Motor 0~10 (Pr.05-33=0) PMSM: 0~5000 (Pr.05-33=1 or 2)	0
✎ 07-27	Slip Compensation Gain (V/F and SVC control mode)	0.00~10.00	0.00 (1 in SVC mode)
✎ 07-29	Slip Deviation Level	0.0~100.0%	0
✎ 07-30	Detection Time of Slip Deviation	0.0~10.0 sec.	1.0
✎ 07-31	Over Slip Treatment	0: Warn and keep operation 1: Warn and ramp to stop 2: Warn and coast to stop 3: No warning	0
✎ 07-32	Motor Hunting Gain	0~10000	1000
✎ 07-33	Auto restart interval of Fault	0.0~6000.0 sec.	60.0

08 High-function PID Parameters

Pr.	Explanation	Settings	Factory Setting
✓ 08-00	Input Terminal for PID Feedback	0: No function 1: Negative PID feedback: on analogue input acc. To setting 5 of Pr. 03-00 to Pr.03-02. 4: Positive PID feedback from external terminal AVI (Pr.03-00)	0
✓ 08-01	Proportional Gain (P)	0.0~100.0%	1.0
✓ 08-02	Integral Time (I)	0.00~100.00 sec.	1.00
✓ 08-03	Derivative Control (D)	0.00~1.00 sec.	0.00
✓ 08-04	Upper Limit of Integral Control	0.0~100.0%	100.0
✓ 08-05	PID Output Frequency Limit	0.0~110.0%	100.0
✓ 08-06	PID feedback value by communication protocol	-200.00~200.00%	Read only
✓ 08-07	PID Delay Time	0.0~35.0 sec.	0.0
✓ 08-08	Feedback Signal Detection Time	0.0~3600.0 sec.	0.0
✓ 08-09	Feedback Signal Fault Treatment	0: Warn and keep operation 1: Warn and ramp to stop 2: Warn and coast to stop 3: Warn and operate at last frequency	0
✓ 08-10	Sleep Frequency	0.00~599.00Hz or 0~200.00%	0.00
✓ 08-11	Wake-up Frequency	0.00~599.00Hz or 0~200.00%	0.00
✓ 08-12	Sleep Time	0.0~6000.0 sec.	0.0
✓ 08-13	PID Deviation Level	1.0~50.0%	10.0
✓ 08-14	PID Deviation Time	0.1~300.0 sec.	5.0
✓ 08-15	Filter time for PID feedback	0.1~300.0 sec.	5.0
✓ 08-16	PID Compensation Selection	0: Parameter setting 1: Analog input	0
✓ 08-17	PID Compensation	-100.0~100.0%	0
✓ 08-18	Setting of Sleep Mode Function	0: Follow PID output command 1: Follow PID feedback signal	0
✓ 08-19	Wakeup Integral Limit	0.0~200.0%	50.0
✓ 08-20	PID Mode Selection	0: Serial connection 1: Parallel connection	0
✓ 08-21	Enable PID to Change Operation Direction	0: Operation direction can be changed 1: Operation direction can not be changed	0
✓ 08-22	Wakeup Delay Time	0.00~600.00 sec.	0.00

09 Communication Parameters

	Pr.	Explanation	Settings	Factory Setting
✓	09-00	COM1 Communication Address	1~254	1
✓	09-01	COM1 Transmission Speed	4.8~115.2Kbps	9.6
✓	09-02	COM1 Transmission Fault Treatment	0: Warn and continue operation 1: Warn and ramp to stop 2: Warn and coast to stop 3: No warning and continue operation	3
✓	09-03	COM1 Time-out Detection	0.0~100.0 sec.	0.0
✓	09-04	COM1 Communication Protocol	1: 7, N, 2 (ASCII) 2: 7, E, 1 (ASCII) 3: 7, O, 1 (ASCII) 4: 7, E, 2 (ASCII) 5: 7, O, 2 (ASCII) 6: 8, N, 1 (ASCII) 7: 8, N, 2 (ASCII) 8: 8, E, 1 (ASCII) 9: 8, O, 1 (ASCII) 10: 8, E, 2 (ASCII) 11: 8, O, 2 (ASCII) 12: 8, N, 1 (RTU) 13: 8, N, 2 (RTU) 14: 8, E, 1 (RTU) 15: 8, O, 1 (RTU) 16: 8, E, 2 (RTU) 17: 8, O, 2 (RTU)	1
✓	09-09	Response Delay Time	0.0~200.0ms	2.0
	09-10	Main Frequency of the Communication	0.00~599.00Hz	60.00
✓	09-11	Block Transfer 1	0~FFFFh	0000
✓	09-12	Block Transfer 2	0~FFFFh	0000
✓	09-13	Block Transfer 3	0~FFFFh	0000
✓	09-14	Block Transfer 4	0~FFFFh	0000
✓	09-15	Block Transfer 5	0~FFFFh	0000
✓	09-16	Block Transfer 6	0~FFFFh	0000
✓	09-17	Block Transfer 7	0~FFFFh	0000
✓	09-18	Block Transfer 8	0~FFFFh	0000
✓	09-19	Block Transfer 9	0~FFFFh	0000
✓	09-20	Block Transfer 10	0~FFFFh	0000
✓	09-21	Block Transfer 11	0~FFFFh	0000
✓	09-22	Block Transfer 12	0~FFFFh	0000
✓	09-23	Block Transfer 13	0~FFFFh	0000
✓	09-24	Block Transfer 14	0~FFFFh	0000
✓	09-25	Block Transfer 15	0~FFFFh	0000
✓	09-26	Block Transfer 16	0~FFFFh	0000
	09-30	Communication Decoding Method	0: Decoding Method 1 (20xx) 1: Decoding Method 2 (60xx)	1

Pr.	Explanation	Settings	Factory Setting
09-31	Internal Communication Protocol	-12: Internal PLC Control -10: Internal Communication Master -8: Internal Communication Slave 8 -7: Internal Communication Slave 7 -6: Internal Communication Slave 6 -5: Internal Communication Slave 5 -4: Internal Communication Slave 4 -3: Internal Communication Slave 3 -2: Internal Communication Slave 2 -1: Internal Communication Slave 1 0: Modbus 485 1: BACnet	0
09-33	PLC command force to 0	0000~FFFFh	0000
09-35	PLC Address	0: Disable 1~254	2
09-36	CANopen Slave Address	0~127	0
09-37	CANopen Speed	0: 1Mbps 1: 500Kbps 2: 250Kbps 3: 125Kbps 4: 100Kbps (Delta only) 5: 50Kbps	0
09-39	CANopen Warning Record	bit 0: CANopen Guarding Time out bit 1: CANopen Heartbeat Time out bit 2: CANopen SYNC Time out bit 3: CANopen SDO Time out bit 4: CANopen SDO buffer overflow bit 5: Can Bus Off bit 6: Error protocol of CANopen bit 8: The setting values of CANopen indexes are fail bit 9: The setting value of CANopen address is fail bit10: The checksum value of CANopen indexes is fail	Read only
09-40	CANopen Decoding Method	0: Delta defined decoding method 1: CANopen DS402 Standard	1
09-41	CANopen Communication Status	0: Node Reset State 1: Com Reset State 2: Boot up State 3: Pre Operation State 4: Operation State 5: Stop State	Read Only
09-42	CANopen Control Status	0: Not ready for use state 1: Inhibit start state 2: Ready to switch on state 3: Switched on state 4: Enable operation state 7: Quick Stop Active state 13: Err Reaction Activation state 14: Error state	Read Only
09-45	CANopen Master Function	0: Disable 1: Enable	0
09-46	CANopen Master Address	0~127	100
09-50	BACnet Dnet	0~127	10
09-51	BACnet Baud Rate	9.66~76.8 Kbps	38.4
09-52	BACnet Device ID L	0~65535	10
09-53	BACnet Device ID H	0~63	0
09-55	BACnet Max Address	0~127	127
09-56	BACnet Password	0~65535	0

Pr.	Explanation	Settings	Factory Setting
09-60	Identifications for Communication Card	0: No communication card 1: DeviceNet Slave 2: Profibus-DP Slave 3: CANopen Slave/Master 4: Modbus-TCP Slave 5: Ethernet/IP Slave	0
09-61	Firmware Version of Communication Card	Read only	##
09-62	Product Code	Read only	##
09-63	Error Code	Read only	##
✓ 09-70	Address of Communication Card (for DeviceNet and PROFIBUS)	DeviceNet: 0~63 Profibus-DP: 1~125	1
✓ 09-71	Setting of DeviceNet Speed (for DeviceNet and PROFIBUS)	Standard DeviceNet: 0: 125Kbps 1: 250Kbps 2: 500Kbps 3: 1Mbps (Delta Only) Nonstandard DeviceNet: (Delta Only) 0: 10Kbps 1: 20Kbps 2: 50Kbps 3: 100Kbps 4: 125Kbps 5: 250Kbps 6: 500Kbps 7: 800Kbps 8: 1Mbps	2
✓ 09-72	Other Setting of DeviceNet Speed (for DeviceNet and PROFIBUS)	0: Standard DeviceNet In this mode, baud rate can only be 100Kbps, 125Kbps, 250Kbps in standard DeviceNet speed 1: Nonstandard DeviceNet In this mode, the baud rate of DeviceNet can be same as CANopen (0-8).	0
✓ 09-75	IP Configuration of the Communication Card (for MODBUS TCP)	0~65535	0
✓ 09-76	IP Address 1 of the Communication Card (for MODBUS TCP)	0~65535	0
✓ 09-77	IP Address 2 of the Communication Card (for MODBUS TCP)	0~65535	0
✓ 09-78	IP Address 3 of the Communication Card (for MODBUS TCP)	0~65535	0
✓ 09-79	IP Address 4 of the Communication Card (for MODBUS TCP)	0~65535	0
✓ 09-80	Address Mask 1 of the Communication Card (for MODBUS TCP)	0~65535	0
✓ 09-81	Address Mask 2 of the Communication Card (for MODBUS TCP)	0~65535	0
✓ 09-82	Address Mask 3 of the Communication Card (for MODBUS TCP)	0~65535	0
✓ 09-83	Address Mask 4 of the Communication Card (for MODBUS TCP)	0~65535	0

Pr.	Explanation	Settings	Factory Setting
✓ 09-84	Gateway Address 1 of the Communication Card (for MODBUS TCP)	0~65535	0
✓ 09-85	Gateway Address 2 of the Communication Card (for MODBUS TCP)	0~65535	0
✓ 09-86	Gateway Address 3 of the Communication Card (for MODBUS TCP)	0~65535	0
✓ 09-87	Gateway Address 4 of the Communication Card (for MODBUS TCP)	0~65535	0
✓ 09-88	Password for Communication Card (Low word) (for MODBUS TCP)	0~99	0
✓ 09-89	Password for Communication Card (High word) (for MODBUS TCP)	0~99	0
✓ 09-90	Reset Communication Card (for MODBUS TCP)	0: No function 1: Reset, return to factory setting	0
✓ 09-91	Additional Setting for Communication Card (for MODBUS TCP)	Bit 0: Enable IP filter Bit 1: Enable to write internet parameters (1bit). This bit will change to disable when it finishes saving the internet parameter updates. Bit 2: Enable login password (1bit). When enter login password, this bit will be enabled. After updating the parameters of communication card, this bit will change to disable.	0
09-92	Status of Communication Card (for MODBUS TCP)	Bit 0: Password enable When the communication card is set with password, this bit is enabled. When the password is clear, this bit is disabled.	0

10 Speed Feedback Control Parameters



NOTE IM: Induction Motor; PM: Permanent Magnet Motor

	Pr.	Explanation	Settings	Factory Setting
✓	10-31	I/F Mode, current command	0~150% of motor rated current	40
✓	10-32	PM Sensorless Observer Bandwidth for High Speed Zone	0.00~600.00Hz	5.00
✓	10-34	PM Sensorless Observer Low-pass Filter Gain	0.00~655.35	1.00
✓	10-39	Frequency when switch from I/F Mode to PM sensorless mode.	0.00~599.00Hz	20.00
✓	10-40	Frequency when switch from I/F sensorless observer mode to V/F mode.	0.00~599.00Hz	20.00
✓	10-41	I/F mode, low pass-filter time	0.0~6.0 sec.	0.2
✓	10-42	Initial Angle Detection Time	0.0~3.0 times of motor rated current	1.0
✓	10-49	Zero voltage time while start up	0.000~60.000 sec.	00.000
✓	10-51	Injection Frequency	0~1200Hz	500
✓	10-52	Injection Magnitude	0.0~200.0V	15.0/30.0
✓	10-53	PM motor rotor initial angle position detection method	0: Disable 1: Internal 1/4 rated current attracting the rotor to zero degrees 2: High frequency injection 3: Pulse injection	0

11 Advanced Parameters

Group 11 Advanced Parameters are reserved.

12 Pump Parameters

Pr.	Explanation	Settings	Factory Setting
12-00	Circulative Control	0: No operation 1: Fixed Time Circulation (by time) 2: Fixed quantity circulation (by PID) 3: Fixed quantity control 4: Fixed Time Circulation + Fixed quantity circulation 5: Fixed Time Circulation + Fixed quantity control	0
12-01	Number of motors to be connected	1~8	1
12-02	Operating time of each motor (minutes)	0~65500 min.	0
12-03	Delay Time due to the Acceleration (or the Increment) at Motor Switching	0.0~3600.0 sec.	1.0
12-04	Delay Time due to the Deceleration (or the Decrement) at Motor Switching (seconds)	0.0~3600.0 sec.	1.0
↗ 12-05	Delay time while fixed quantity circulation at Motor Switching (seconds)	0.0~3600.0 sec.	10.0
↗ 12-06	Frequency when switching motors at fixed quantity circulation (Hz)	0.00~599.00 Hz	60.00
12-07	Action to do when Fixed Quantity Circulation breaks down.	0: Turn off all output 1: Motors powered by mains electricity continues to operate.	0
↗ 12-08	Frequency when stopping auxiliary motor (Hz)	0.00~599.00 Hz	0.00

13 Application Parameters by Industry

Pr.	Explanation	Settings	Factory Setting
13-00	Application selection	0: Disabled 1: User Parameter 2: Compressor IM 3: Fan 4: Pump 10: Air Handling Unit (AHU)	0
13-01 ~ 13-99	Application Parameter 1~99	00.00~655.35	00.00

Chapter 12 Description of Parameter Settings

12-1 Description of parameter settings

00 Drive Parameters

✎ This parameter can be set during operation.

00-00 Identity Code of the AC Motor Drive

Factory Setting: ##

Settings Read Only

00-01 Display AC Motor Drive Rated Current

Factory Setting: ##

Settings Read Only

- 📖 Pr. 00-00 displays the identity code of the AC motor drive. Using the following table to check if Pr.00-01 setting is the rated current of the AC motor drive. Pr.00-01 corresponds to the identity code Pr.00-00.
- 📖 The factory setting is the rated current for light duty. Please set Pr.00-16 to 1 to display the rated current for normal duty.

Frame	A							B	
kW	0.75	1.5	2.2	3.7	4.0	5.5	7.5	11	15
HP	1	2	3	5	5.5	7.5	10	15	20
Pr.00-00	5	7	9	11	93	13	15	17	19
Rated Current for Light Duty [A]	3	4.2	5.5	8.5	10.5	13	18	24	32
Rated Current for Normal Duty [A]	1.7	3.0	4.0	6.0	9.0	10.5	12	18	24

Frame	B		C		D0		D	
kW	18.5	22	30	37	45	55	75	90
HP	25	30	40	50	60	75	100	125
Pr.00-00	21	23	25	27	29	31	33	35
Rated Current for Light Duty [A]	38	45	60	73	91	110	150	180
Rated Current for Normal Duty [A]	32	38	45	60	73	91	110	150

00-02 Parameter Reset

Factory Setting: 0

Settings 0: No Function

1: Parameter write protect

5: Reset KWH display to 0



6: Reset PLC (including CANopen Master Index)

7: Reset CANopen Index (Slave)

9: All parameters are reset to factory settings(base frequency is 50Hz)

10: All parameters are reset to factory settings (base frequency is 60Hz)

- 📖 When it is set to 1, all parameters are read only except Pr.00-02, 00-07, 00-08 and it can be used with password setting for password protection. It needs to set Pr.00-02 to 0 before changing other parameter settings.
- 📖 When it is set to 5, KWH display value can be reset to 0 even when the drive is operating. Pr. 05-26, 05-27, 05-28, 05-29, 05-30 reset to 0.
- 📖 When it is set to 6: clear internal PLC program (includes the related settings of PLC internal CANopen master)

-  When it is set to 7: reset the related settings of CANopen slave.
-  When it is set to 9 or 10: all parameters are reset to factory settings. If password is set in Pr.00-08, input the password set in Pr.00-07 to reset to factory settings.
-  When it is set to 6、7、9、10, please re-power the motor drive after setting.

 **00-03** Start-up Display Selection

Factory setting: 0

- Settings
- 0: Display the frequency command (F)
 - 1: Display the actual output frequency (H)
 - 2: Display User define (U)
 - 3: Output current (A)

 This parameter determines the start-up display page after power is applied to the drive. User defined choice display according to the setting in Pr.00-04.

 **00-04** Content of Multi-function Display

Factory setting: 3

- Settings
- 0: Display output current (A) (Unit: Amps)
 - 1: Display counter value (c) (Unit: CNT)
 - 2: Display actual output frequency (H) (Unit: Hz)
 - 3: Display DC-BUS voltage (v) (Unit: VDC)
 - 4: Display output voltage (E) (Unit: VAC)
 - 5: Display output power angle (n) (Unit: deg)
 - 6: Display output power in kW (P) (Unit: kW)
 - 7: Display actual motor speed rpm (r = 00: positive speed; -00 negative speed) (Unit: rpm)
 - 10: Display PID feedback (b) (Unit: %)
 - 11: Display AVI1 in % (1.), 0~10V/4~20mA/0~20mA corresponds to 0~100% (Refer to Note 2) (Unit: %)
 - 12: Display ACI in % (2.), 4~20mA/0~10V/0~20mA corresponds to 0~100% (Refer to Note 2) (Unit: %)
 - 13: Display AVI2 in % (3.), 0V~10V corresponds to 0~100% (Refer to Note 2) (Unit: %)
 - 14: Display the temperature of IGBT (i.) (Unit: °C)
 - 15: Display the temperature of capacitance (c.) (Unit: °C)
 - 16: The status of digital input (ON/OFF) refer to Pr.02-12 (i) (Refer to Note3)
 - 17: Display digital output status ON/OFF (Pr.02-18) (o) (refer to NOTE 4)
 - 18: Display the multi-step speed that is executing (S)
 - 19: The corresponding CPU pin status of digital input (d) (refer to NOTE 3)
 - 20: The corresponding CPU pin status of digital output (O.) (refer to NOTE 4)
 - 25: Overload counting (0.00~100.00%) (h.) (Refer to Note 6) (Unit: %)
 - 26: GFF Ground Fault (G.) (Unit: %)
 - 27: DC Bus voltage ripple (r.) (Unit: %)

- 28: Display PLC register D1043 data (C) display in hexadecimal
- 30 : Display output of user defined (U)
- 31 : H page x 00-05 Display user Gain(K)
- 34: Operation speed of fan (F.) (Unit: %)
- 36: Present operating carrier frequency of drive (Hz) (J.)
- 38: Display drive status (6.) (Refer to Note 7)
- 41: KWH display (J) (Unit: kWh)
- 42: PID reference (h) (Unit: %)
- 43: PID offset (o.) (Unit: %)
- 44: PID output frequency (b.) (Unit: Hz)
- 45: Hardware ID (0)

 **NOTE**

1. It can display negative values when setting analog input bias (Pr.03-03~03-10).
Example: assume that AVI1 input voltage is 0V, Pr.03-03 is 10.0% and Pr.03-07 is 4 (Serve bias as the center).
2. Example: If REV, MI1 and MI6 are ON, the following table shows the status of the terminals.
0: OFF, 1: ON

Terminal	MI15	MI14	MI13	MI12	MI11	MI10	MI8	MI7	MI6	MI5	MI4	MI3	MI2	MI1	REV	FWD
Status	0	0	0	0	0	0	0	0	1	0	0	0	0	1	1	0

MI10~MI15 are the terminals for extension cards (Pr.02-26~02-31).

If REV, MI1 and MI6 are ON, the value is 0000 0000 1000 0110 in binary and 0086h in HEX. When Pr.00-04 is set to "16" or "19", it will display "0086h" with LED U is ON on the keypad KPC-CC02. The setting 16 is the status of digital input by Pr.02-12 setting and the setting 19 is the corresponding CPU pin status of digital input, the FWD/REV action and the three-wire MI are not controlled by Pr.02-12. User can set to 16 to monitor digital input status and then set to 19 to check if the wire is normal.

3. Assume that RY1: Pr.02-13 is set to 9 (Drive ready). After applying the power to the AC motor drive, if there is no other abnormal status, the contact will be ON. The display status will be shown as follows.

N.O. switch status:

Terminal	MO20~MO17				MO16~MO13				MO12~MO10				Reserved		RY3	RY2	RY1
Status	0	0	0	0	0	0	0	0	0	0	0	0	0	0	0	0	1

At the meanwhile, if Pr.00-04 is set to 17 or 20, it will display in hexadecimal "0001h" with LED U is ON on the keypad. The setting 17 is the status of digital output by Pr.02-18 setting and the setting 20 is the corresponding CPU pin status of digital output. User can set 17 to monitor the digital output status and then set to 20 to check if the wire is normal.





4. If Pr.00-04 = 25, when display value reaches 100.00%, the drive will show "oL" as an overload warning.
5. If Pr.00-04 = 38,
 - Bit 0: The drive is running forward.
 - Bit 1: The drive is running backward.
 - Bit 2: The drive is ready.
 - Bit 3: Errors occurred on the drive.
 - Bit 4: The drive is running.
 - Bit 5: Warnings on the drive.

↗	00-05	Coefficient Gain in Actual Output Frequency	Factory Setting: 1.00
	Settings	0.00~160.00	



 This parameter is to set coefficient gain in actual output frequency. Set Pr.00-04= 31 to display the calculation result on the screen (calculation = output frequency * Pr.00-05).

↗	00-06	Software Version	Factory Setting: Read only
	Settings	Read only	

↗	00-07	Parameter Protection Password Input	Factory Setting: 0
	Settings	0~65535	
	Display	0~4 (the times of password attempts)	

-  This parameter allows user to enter their password (which is set in Pr.00-08) to unlock the parameter protection and to make changes to the parameter.
-  Pr.00-07 and Pr.00-08 are used to prevent the personal miss-operation.
-  When the user have forgotten the password, clear the setting by input 9999 and press ENTER key, then input 9999 again and press Enter within 10 seconds. After decoding, all the settings will return to factory setting.
-  All parameters will be read as 0 when the password is setting, except Pr.00-08.

↗	00-08	Parameter Protection Password Setting	Factory Setting: 0
	Settings	0~65535	
		0: No password protection / password is entered correctly (Pr00-07)	
		1: Password has been set	

-  To set a password to protect your parameter settings. In the first time, password can be set directly. After setting, the value of 00-08 will become 1, which means password protection is activated. When the password is set, if any parameter setting needs to be changed, be sure to enter correct password in 00-07, and then the password will be inactivated temporarily with 00-08 changing to 0. At this time, parameters setting can be changed. After setting, re-power the motor drive, and password will be activated again.
-  To cancel the password protection, after entering correct password in 00-07, 00-08 also needs to be set as 0 again to inactive password protection permanently. If not, password protection will be active after motor drive re-power.
-  The keypad copy function will work normally only when the password protection is inactivated temporarily or permanently, and password set in 00-08 will not be copied to keypad. So when copying parameters from keypad to motor drive, the password need to be set manually again in the motor drive to active password protection.

Password Decode Flow Chart

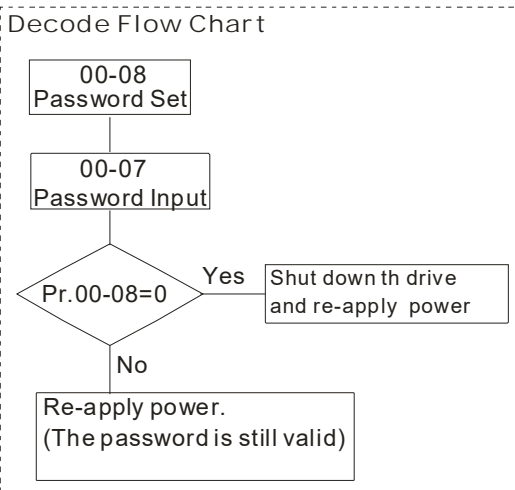
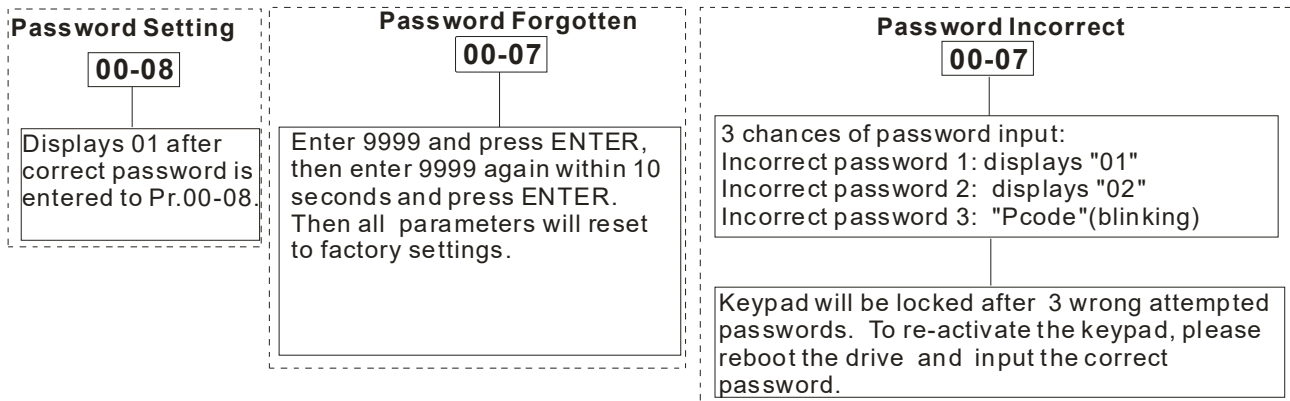

00-11 Control of Speed Mode

Factory Setting: 0

- Settings 0: VF (IM V/F control)
2: SVC(IM/PM sensorless vector control)

- This parameter determines the control method of the AC motor drive:
0: (IM V/F control): user can design proportion of V/F as required and can control multiple motors simultaneously.
2: (IM/PM Sensorless vector control): get the optimal control by the auto-tuning of motor parameters.

When 00-10=0, and set Pr.00-11 to 0, the V/F control diagram is shown as follows.

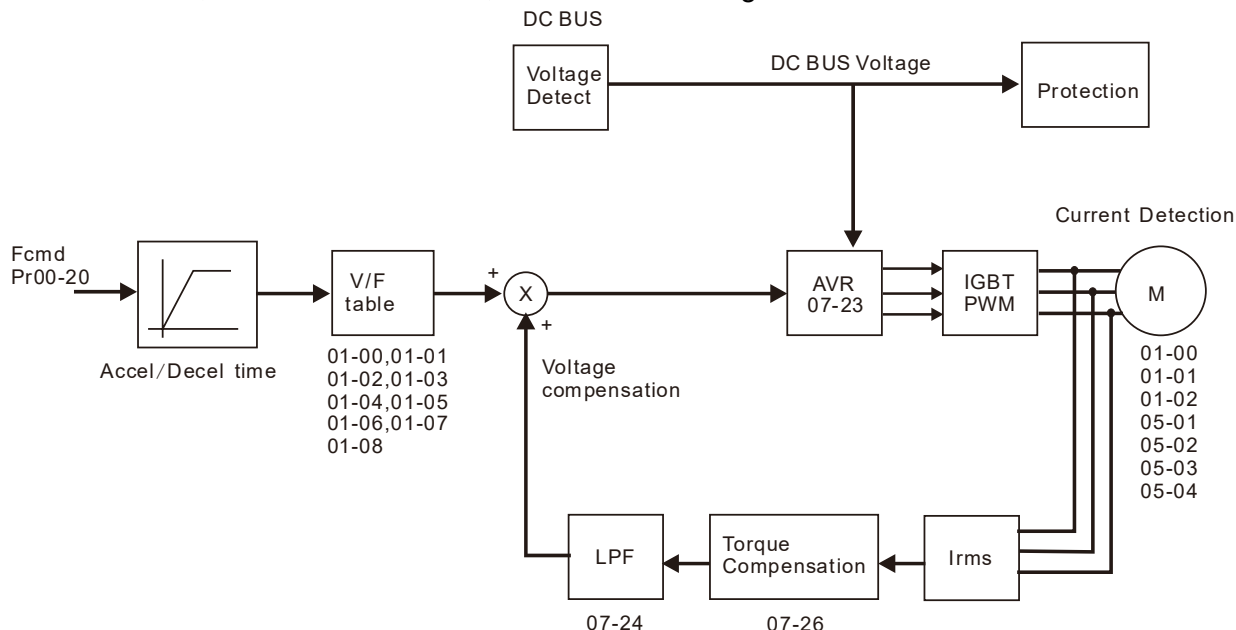

When 00-10=0, and set Pr.00-11 to 2, the sensorless vector control diagram is shown as follows.

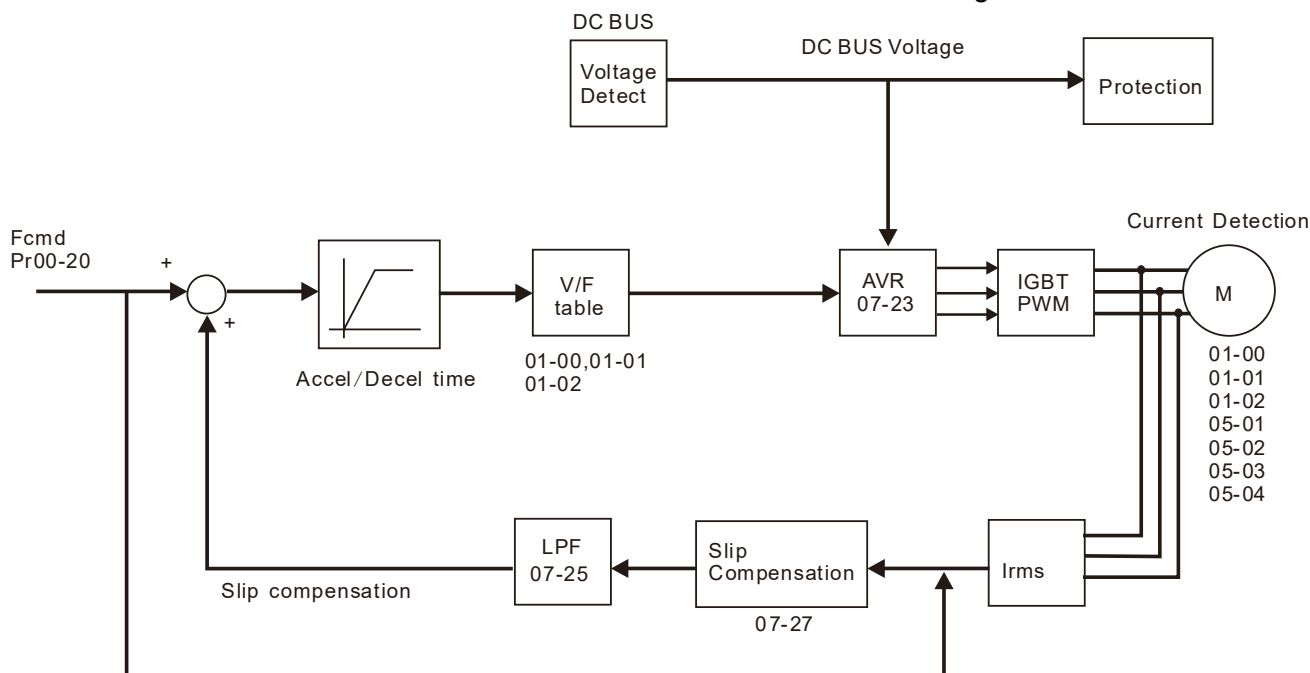

00-16 Duty Selection

Factory Setting: 0

- Settings 0: Light duty
- 1: Normal duty

Light duty: over load ability is 120% rated output current in 60 second. Please refer to Pr.00-17 for the setting of carrier. Refer to chapter 9 (specifications) or Pr.00-01 for the rated current.

Normal duty: over load ability is 120% rated output current in 60 second (over load ability is 160% rated output current in 3 second). Please refer to Pr.00-17 for the setting of carrier wave. Refer to chapter 9 (specifications) or Pr.00-01 for the rated current.

The default setting and maximum setting range of Pr.06-03, 06-04 will change as the setting of Pr.00-16 changes.

00-17 Carrier Frequency

Factory setting: Table below

- Settings 2~15kHz

This parameter determines the PWM carrier frequency of the AC motor drive.

Models	1~25HP [0.75~18.5kW]	30~100HP [22~75kW]	125HP [90kW]
Setting Range	02~15kHz	02~10kHz	02~09kHz
Normal Duty Factory Setting	6kHz	6kHz	6kHz
Light Duty Factory Setting	6kHz	6kHz	6kHz

Carrier Frequency	Acoustic Noise	Electromagnetic Noise or Leakage Current	Heat Dissipation	Current Wave
1kHz	Significant ↑↓ Minimal	Minimal ↑↓ Significant	Minimal ↑↓ Significant	
8kHz				
15kHz				

- 📖 From the table, we see that the PWM carrier frequency has a significant influence on the electromagnetic noise, AC motor drive heat dissipation, and motor acoustic noise. Therefore, if the surrounding noise is greater than the motor noise, lower the carrier frequency is good to reduce the temperature rise. Although it is quiet operation in the higher carrier frequency, the entire wiring and interference resistance should be considerate.
- 📖 When the carrier frequency is higher than the factory setting, it needs to protect by decreasing the carrier frequency. See Pr.06-55 for the related setting and details.

00-19 PLC Command Mask (SOOC, SOOF, SOTC)

Factory Setting: Read Only

Settings Bit 0: Control command by PLC force control
 Bit 1: Frequency command by PLC force control

- 📖 This parameter determines if frequency command or control command is occupied by PLC

00-20 Source of the Master Frequency Command (AUTO)

Factory Setting: 0

Settings 0: Digital keypad
 1: RS-485 serial communication
 2: External analog input (Pr.03-00)
 3: External UP/DOWN terminal
 6: CANopen communication card
 8: Communication card (no CANopen card)

- 📖 It is used to set the source of the master frequency in AUTO mode.
- 📖 Pr.00-20 and 00-21 are for the settings of frequency source and operation source in AUTO mode. Pr.00-30 and 00-31 are for the settings of frequency source and operation source in HAND mode. The AUTO/HAND mode can be switched by the keypad KPC-CC02 or multi-function input terminal (MI).
- 📖 The factory setting of frequency source or operation source is for AUTO mode. It will return to AUTO mode whenever re-power after power off. If there is multi-function input terminal used to switch AUTO/HAND mode, the highest priority is the multi-function input terminal. When the external terminal is OFF, the drive will not receive any operation signal and cannot execute JOG.

00-21 Source of the Operation Command (AUTO)

Factory Setting: 0

Settings 0: Digital keypad
 1: External terminals. Keypad STOP disabled.
 2: RS-485 serial communication. Keypad STOP disabled.
 3: CANopen card
 5: Communication card (not include CANopen card)

- 📖 It is used to set the source of the operation frequency in AUTO mode.
- 📖 When the operation command is controlled by the keypad KPC-CC02, keys RUN, STOP and JOG (F1) are valid.

00-22 Stop Method

Factory Setting: 0

- Settings 0: Ramp to stop
- 1: Coast to stop

The parameter determines how the motor is stopped when the AC motor drive receives a valid stop command.

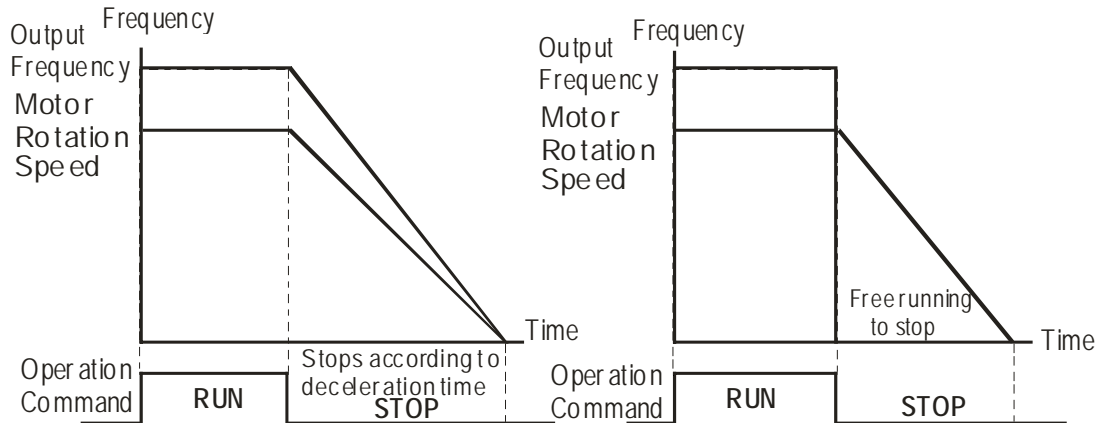

Ramp to Stop and Coast to Stop

Ramp to stop: the AC motor drive decelerates from the setting of deceleration time to 0 or minimum output frequency (Pr. 01-09) and then stop (by Pr.01-07).

Coast to stop: the AC motor drive stops the output instantly upon a STOP command and the motor free runs until it comes to a complete standstill.

(1) It is recommended to use “ramp to stop” for safety of personnel or to prevent material from being wasted in applications where the motor has to stop after the drive is stopped. The deceleration time has to be set accordingly.

(2) If the motor free running is allowed or the load inertia is large, it is recommended to select “coast to stop”. For example, blowers, punching machines and pumps

00-23 Control of Motor Direction

Factory Setting: 0

- Settings 0: Enable forward/ reverse
- 1: Disable reverse
- 2: Disable forward

This parameter enables the AC motor drives to run in the forward/reverse Direction. It may be used to prevent a motor from running in a direction that would consequently injure the user or damage the equipment.

00-24 Memory of Digital Operator (Keypad) Frequency Command

Factory Setting: Read Only

- Settings Read only

If keypad is the source of frequency command, when Lv or Fault occurs, the present frequency command will be saved in this parameter.

 **00-25** User Defined Characteristics

Factory Setting: 0

Settings Bit 0~3: user defined decimal place
 0000h --- 0000B: no decimal place
 0001h --- 0001B: one decimal place
 0002h --- 0010B: two decimal place
 0003h --- 0011B: three decimal place
 Bit 4~15: user defined unit
 000xh: Hz
 001xh: rpm
 002xh: %
 003xh: kg
 004xh: m/s
 005xh: kW
 006xh: HP
 007xh: ppm
 008xh: 1/m
 009xh: kg/s
 00Axh: kg/m
 00Bxh: kg/h
 00Cxh: lb/s
 00Dxh: lb/m
 00Exh: lb/h
 00Fhx: ft/s
 010xh: ft/m
 011xh: m
 012xh: ft
 013xh: degC
 014xh: degF
 015xh: mbar
 016xh: bar
 017xh: Pa
 018xh: kPa 019xh: mWG
 01Axh: inWG
 01Bxh: ftWG
 01Cxh: psi
 01Dxh: atm
 01Exh: L/s
 01Fhx: L/m
 020xh: L/h
 021xh: m³/s
 022xh: m³/h
 023xh: GPM
 024xh: CFM
 xxxhx: Hz

 Bit 0~3: Control F page, unit of user defined value (Pr00-04 =d10, PID feedback) and the decimal point of Pr00-26 which supports up to 3 decimal points.

 Bit 4~15: Control F page, unit of user defined value (Pr00-04=d10, PID feedback) and the display units of Pr00-26.

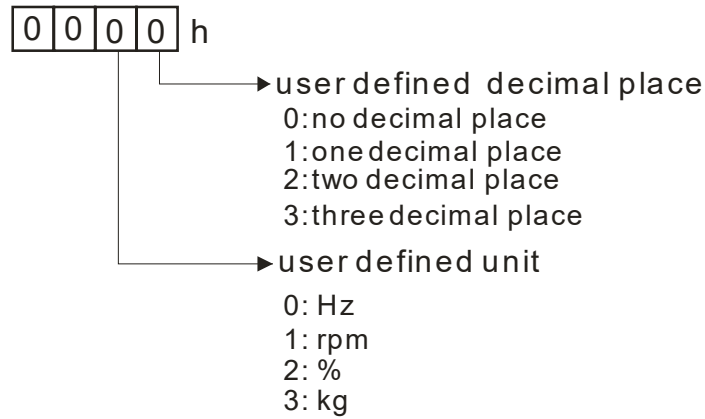

00-26 Max. User Defined Value Factory Setting: 0

- Settings 0: Disable
 0~65535 (when Pr.00-25 set to no decimal place)
 0.0~6553.5 (when Pr.00-25 set to 1 decimal place)
 0.00~655.35 (when Pr.00-25 set to 2 decimal place)
 0.000~65.535 (when Pr.00-25 set to 3 decimal place)

When Pr.00-26 is NOT set to 0. The user-defined value is enabled. The value of this parameter should correspond to the frequency setting at Pr.01-00.

Example:

When the frequency at Pr. 01-00=60.00Hz, the max. user defined value at Pr. 00-26 is 100.0%. That also means Pr.00-25 is set at 0021h to select % as the unit.

NOTE

The drive will display as Pr.00-25 setting when Pr.00-25 is properly set and Pr.00-26 is not 0.

00-27 User Defined Value Factory Setting: Read only

- Settings Read only

Pr.00-27 will show user defined value when Pr.00-26 is not set to 0.

User defined value is only valid in Pr. 00-20, with frequency source input from keypad or RS-485.





00-28 Switching from Auto mode to Hand mode Factory Setting: 0

- Settings bit0: Sleep Function Control Bit
 0: Sleep Function Control Bit
 1: Sleep function and Auto mode are the same
 bit1: Unit of the Control Bit
 0: Displaying Unit in Hz
 1: Same unit as the Auto mode
 bit2: PID Control Bit
 0: Cancel PID control
 1: PID control and Auto mode are the same.
 bit3: Frequency Source Control Bit
 0: Frequency command set by parameter, if the multi-step speed is activated, then multi-step speed has the priority.
 1: Frequency command set by Pr00-30, regardless if the multi-speed is activated.

00-29 LOCAL/REMOTE Selection

Factory Setting: 0

- Settings
- 0: Standard HOA function
 - 1: Switching Local/Remote, the drive stops
 - 2: Switching Local/Remote, the drive runs as the REMOTE setting for frequency and operation status
 - 3: Switching Local/Remote, the drive runs as the LOCAL setting for frequency and operation status
 - 4: Switching Local/Remote, the drive runs as LOCAL setting when switch to Local and runs as REMOTE setting when switch to Remote for frequency and operation status.

-  The factory setting of Pr.00-29 is 0 (standard Hand-Off-Auto function). The AUTO frequency and source of operation can be set by Pr.00-20 and Pr.00-21, and the HAND frequency and source of operation can be set by Pr.00-30 and Pr.00-31. AUTO/HAND mode can be selected or switched by using digital keypad (KPC-CC02) or setting multi-function input terminal MI= 41, 42.
-  When external terminal MI is set to 41 and 42 (AUTO/HAND mode), the settings Pr.00-29=1,2,3,4 will be disabled. The external terminal has the highest priority among all command, Pr.00-29 will always function as Pr.00-29=0, standard HOA mode.
-  When Pr.00-29 is not set to 0, Local/Remote function is enabled, the top right corner of digital keypad (KPC-CC02) will display "LOC" or "REM". The LOCAL frequency and source of operation can be set by Pr.00-20 and Pr.00-21, and the REMOTE frequency and source of operation can be set by Pr.00-30 and Pr.00-31. Local/Remote function can be selected or switched by using digital keypad (KPC-CC02) or setting external terminal MI=56. The AUTO key of the digital keypad now controls for the REMOTE function and HAND key now controls for the LOCAL function.
-  When MI is set to 56 for LOC/REM selection, if Pr.00-29 is set to 0, then the external terminal is disabled.
-  When MI is set to 56 for LOC/REM selection, if Pr.00-29 is not set to 0, the external terminal has the highest priority of command and the ATUO/HAND keys will be disabled.

00-30 Source of the Master Frequency Command (HAND)

Factory Setting: 0



- Settings
- 0: Digital keypad
 - 1: RS-485 serial communication
 - 2: External analog input (Pr.03-00)
 - 3: External UP/DOWN terminal
 - 6: CANopen communication card
 - 8: Communication card (no CANopen card)

-  It is used to set the source of the master frequency in HAND mode.

00-31 Source of the Operation Command (HAND)

Factory Setting: 0

- Settings
- 0: Digital keypad
 - 1: External terminals. Keypad STOP disabled.
 - 2: RS-485 serial communication. Keypad STOP disabled.
 - 3: CANopen communication card
 - 5: Communication card (not include CANopen card)

-  It is used to set the source of the operation frequency in HAND mode.
-  Pr.00-20 and 00-21 are for the settings of frequency source and operation source in AUTO mode. Pr.00-30 and 00-31 are for the settings of frequency source and operation source in HAND mode. The AUTO/HAND mode can be switched by the keypad KPC-CC02 or multi-function input terminal (MI).
-  The factory setting of frequency source or operation source is for AUTO mode. It will return to AUTO mode whenever power on again after power off. If there is multi-function input terminal used to switch AUTO/HAND mode. The highest priority is the multi-function input terminal. When the external terminal is OFF, the drive won't receive any operation signal and can't execute JOG.

 **00-32** Digital Keypad STOP Function

Factory Setting: 0

- Settings
- 0: STOP key disable
 - 1: STOP key enable

-  This parameter works when the source of operation command is not digital keypad (Pr00-21 ≠ 0). When Pr00-21=0, the stop key will not follow the setting of this parameter.

 **00-48** Display Filter Time (Current)

Factory Settings: 0.100

Settings: 0.001~65.535 sec

-  Set this parameter to minimize the current fluctuation displayed by digital keypad.

 **00-49** Display Filter Time (Keypad)

Factory Settings: 0.100

Settings: 0.001~65.535 sec

-  Set this parameter to minimize the display value fluctuation displayed by digital keypad.

00-50 Software Version (date)

Factory Settings: Read Only

Settings: Read only

-  This parameter displays the drive's software version by date.

01 Basic Parameters

✎ This parameter can be set during operation.

01-00 Maximum Output Frequency

Factory Setting: 60.00/50.00

Settings 50.00~599.00Hz

Setting Range for /including 90kW(125HP) and above: 0.00~400.00Hz

📖 This parameter determines the AC motor drive's Maximum Output Frequency. All the AC motor drive frequency command sources (analog inputs 0 to +10V, 4 to 20mA, 0 to 20mA) are scaled to correspond to the output frequency range.

Minimum Carrier Wave Requirement	Maximum Output Frequency IM VF/ IM SVC
2k	200 Hz
3k	300 Hz
4k	400 Hz
5k	500 Hz
6k	599 Hz

01-01 Output Frequency of Motor 1 (base frequency and motor rated frequency)

01-35 Output Frequency of Motor 2 (base frequency and motor rated frequency)

Factory Setting: 60.00/50.00

Settings 0.00~599.00Hz

📖 This value should be set according to the rated frequency of the motor as indicated on the motor nameplate. If the motor is 60Hz, the setting should be 60Hz. If the motor is 50Hz, it should be set to 50Hz.

01-02 Output Voltage of Motor 1 (base frequency and motor rated frequency)

01-36 Output Voltage of Motor 2 (base frequency and motor rated frequency)

Factory Setting: 400.0

Settings 0.0~510.0V

📖 This value should be set according to the rated voltage of the motor as indicated on the motor nameplate. If the motor is 220V, the setting should be 220.0. If the motor is 200V, it should be set to 200.0.

📖 There are many motor types in the market and the power system for each country is also different. The economic and convenience method to solve this problem is to install the AC motor drive. There is no problem to use with the different voltage and frequency and also can amplify the original characteristic and life of the motor.

01-03 Mid-point Frequency 1 of Motor 1

Factory Setting: 3.00





Settings 0.00~599.00Hz

✎ **01-04** Mid-point Voltage 1 of Motor 1

Factory Setting: 22.0

Settings 0.0~480.0V

01-37	Mid-point Frequency 1 of Motor 2	Factory Setting: 3.00
	Settings 0.00~599.00Hz	
01-38	Mid-point Voltage 1 of Motor 2	Factory Setting: 22.0
	Settings 0.0~480.0V	
01-05	Mid-point Frequency 2 of Motor 1	Factory Setting: 1.50
	Settings 0.00~599.00Hz	
01-06	Mid-point Voltage 2 of Motor 1	Factory Setting: 10.0
	Settings 0.0~480.0V	
01-39	Mid-point Frequency 2 of Motor 2	Factory Setting: 1.50
	Settings 0.00~599.00Hz	
01-40	Mid-point Voltage 2 of Motor 2	Factory Setting: 10.0
	Settings 0.0~480.0V	
01-07	Min. Output Frequency of Motor 1	Factory Setting: 0.50
	Settings 0.00~599.00Hz	
01-08	Min. Output Voltage of Motor 1	Factory Setting: 2.0
	Settings 0.0~480.0V	
01-41	Min. Output Frequency of Motor 2	Factory Setting: 0.50
	Settings 0.00~599.00Hz	
01-42	Min. Output Voltage of Motor 2	Factory Setting: 2.0
	Settings 0.0~480.0V	

-  V/F curve setting is usually set by the motor's allowable loading characteristics. Pay special attention to the motor's heat dissipation, dynamic balance, and bearing lubricity, if the loading characteristics exceed the loading limit of the motor.
-  There is no limit for the voltage setting, but a high voltage at low frequency may cause motor damage, overheat, and stall prevention or over-current protection. Therefore, please use the low voltage at the low frequency to prevent motor damage.
-  Pr.01-35 to Pr.01-42 is the V/F curve for the motor 2. When multi-function input terminals Pr.02-01~02-08 and Pr.02-26 ~Pr.02-31 are set to 14 and enabled, the AC motor drive will act as the 2nd V/f curve.
-  The V/F curve for the motor 1 is shown as follows. The V/F curve for the motor 2 can be deduced from it.

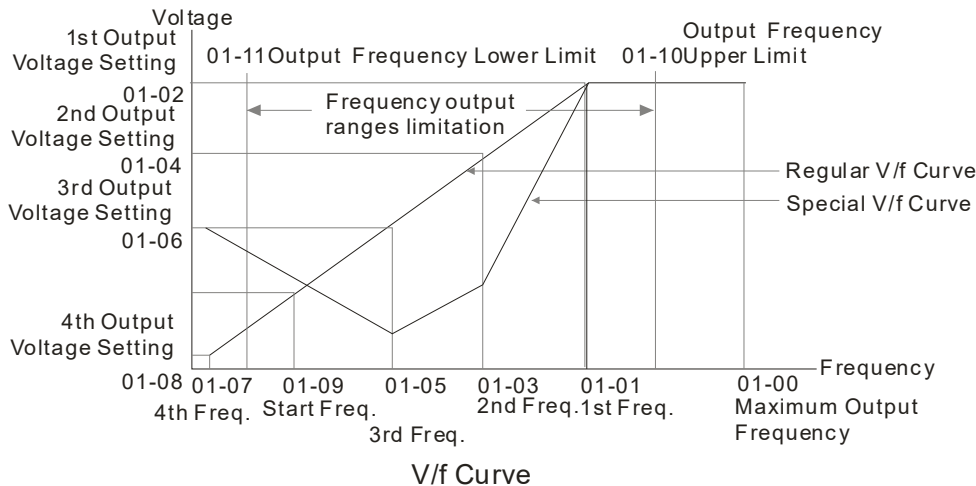

Common settings of V/F curve:

(1) General purpose

Motor spec. 60Hz

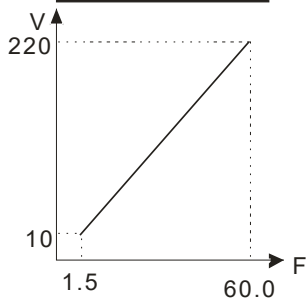

Pr.	Setting
01-00	60.0
01-01	60.0
01-02	220.0
01-03	1.50
01-05	1.50
01-04	10.0
01-06	1.50
01-07	1.50
01-08	10.0

Motor spec. 50Hz

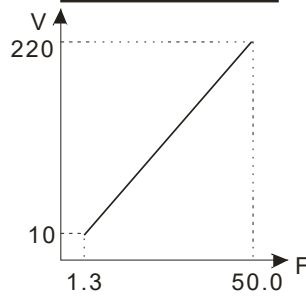

Pr.	Setting
01-00	50.0
01-01	50.0
01-02	220.0
01-03	1.30
01-05	1.30
01-04	10.0
01-06	1.30
01-07	1.30
01-08	10.0

(2) Fan and hydraulic machinery

Motor spec. 60Hz

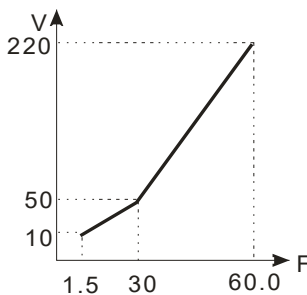

Pr.	Setting
01-00	60.0
01-01	60.0
01-02	220.0
01-03	30.0
01-05	30.0
01-04	50.0
01-06	50.0
01-07	1.50
01-08	10.0

Motor spec. 50Hz

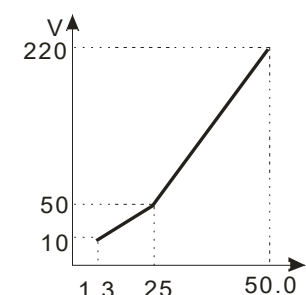

Pr.	Setting
01-00	50.0
01-01	50.0
01-02	220.0
01-03	25.0
01-05	25.0
01-04	50.0
01-06	50.0
01-07	1.30
01-08	10.0

(3) High starting torque

Motor spec. 60Hz

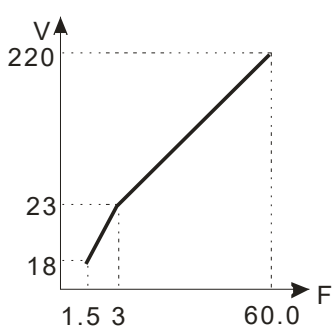

Pr.	Setting
01-00	60.0
01-01	60.0
01-02	220.0
01-03	3.00
01-05	3.00
01-04	23.0
01-06	23.0
01-07	1.50
01-08	18.0

Motor spec. 50Hz

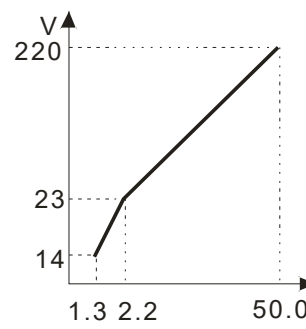

Pr.	Setting
01-00	50.0
01-01	50.0
01-02	220.0
01-03	2.20
01-05	2.20
01-04	23.0
01-06	23.0
01-07	1.30
01-08	14.0

01-09 Start-Up Frequency

Factory Setting: 0.50

Settings 0.0~599.00Hz

When start frequency is higher than the min. output frequency, drives' output will be from start

frequency to the setting frequency. Please refer to the following diagram for details.

- 📖 Fcmd=frequency command,
- Fstart=start frequency (Pr.01-09),
- fstart=actual start frequency of drive,
- Fmin=4th output frequency setting (Pr.01-07/Pr.01-41),
- Flow=output frequency lower limit (Pr.01-11)

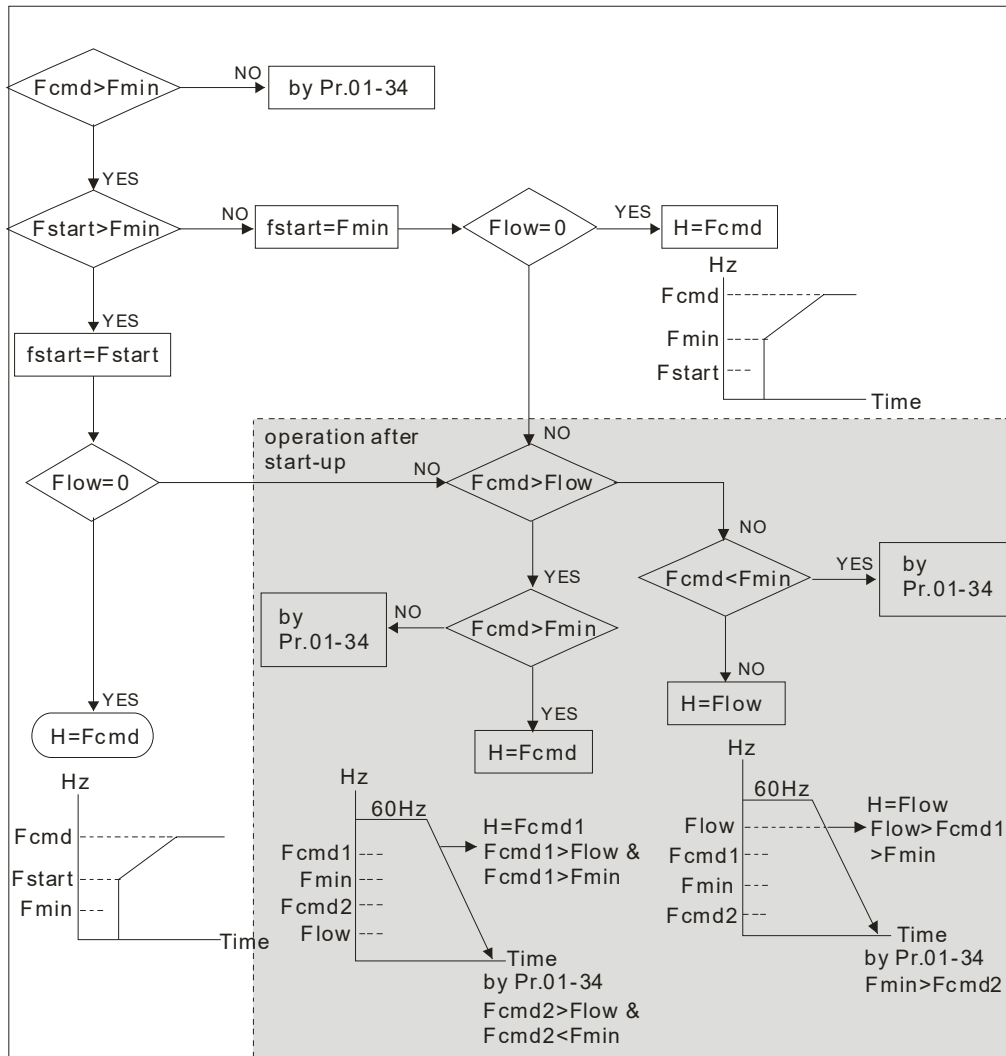

📖 Fcmd > Fmin and Fcmd < Fstart:

- 📖 If Flow < Fcmd , drive will run with Fcmd directly.
- 📖 If Flow >= Fcmd, drive will run with Fcmd firstly, then, accelerate to Flow according to acceleration time.

📖 The drive's output will stop immediately when output frequency has reach to Fmin during deceleration.

⚡ **01-10** Output Frequency Upper Limit

Factory Setting: 599.00

Settings 0.0~599.00Hz

⚡ **01-11** Output Frequency Lower Limit

Factory Setting: 0.00

Settings 0.0~599.00Hz

- 📖 The upper/lower output frequency setting is used to limit the actual output frequency. If the frequency setting is higher than the upper limit (Pr.01-10), it will run with the upper limit frequency. If output frequency lower than output frequency lower limit (Pr.01-11) and frequency setting is higher than min. frequency (Pr.01-07), it will run with lower limit frequency. The upper limit frequency should be set to be higher than the lower limit frequency. Pr.01-10 setting must be \geq Pr.01-11 setting.
- 📖 Upper output frequency will limit the max. Output frequency of drive. If frequency setting is higher than Pr.01-10, the output frequency will be limited by Pr.01-10 setting.
- 📖 When the drive starts the function of slip compensation (Pr.07-27) or PID feedback control, drive output frequency may exceed frequency command but still be limited by this setting.
- 📖 Related parameters: Pr.01-00 Max. Operation Frequency and Pr.01-11 Output Frequency Lower Limit

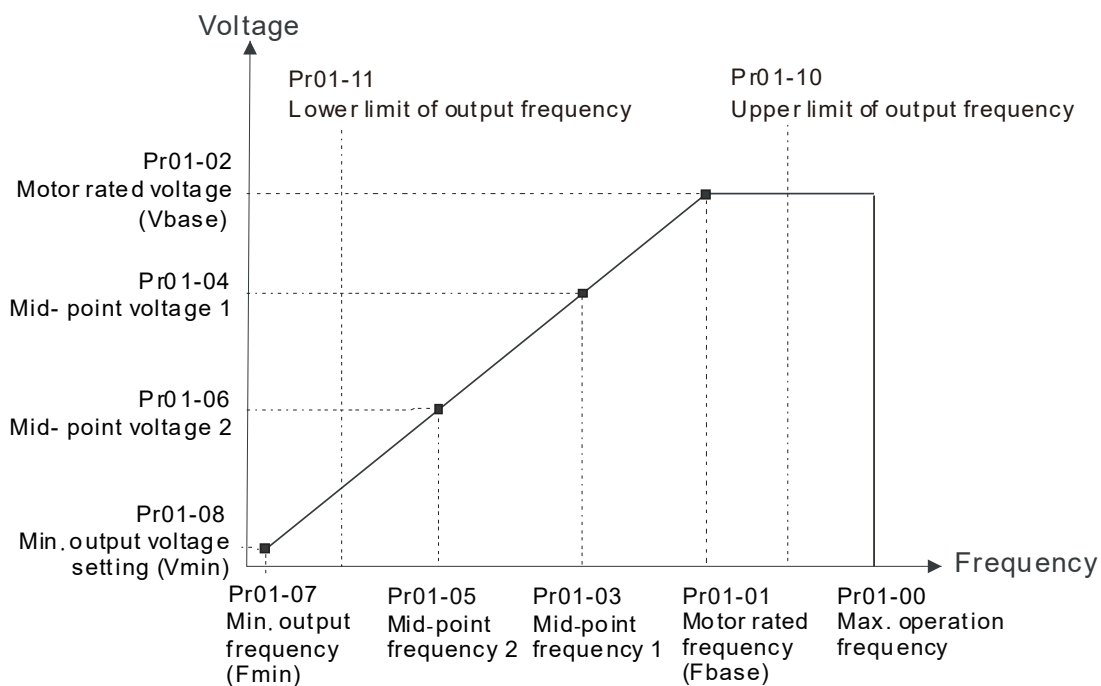

- 📖 Lower output frequency will limit the min. output frequency of drive. When drive frequency command or feedback control frequency is lower than this setting, drive output frequency will limit by the lower limit of frequency.
- 📖 When the drive starts, it will operate from min. output frequency (Pr.01-07) and accelerate to the setting frequency. It won't limit by lower output frequency setting.
- 📖 The setting of output frequency upper/lower limit is used to prevent personal miss-operation, overheat due to too low operation frequency or damage due to too high speed.
- 📖 If the output frequency upper limit setting is 50Hz and frequency setting is 60Hz, max. output frequency will be 50Hz.
- 📖 If the output frequency lower limit setting is 10Hz and min. operation frequency setting (Pr.01-07) is 1.5Hz, it will operate by 10Hz when the frequency command is greater than Pr.01-07 and less than 10Hz. If the frequency command is less than Pr.01-07, the drive will be in ready status and no output.
- 📖 If the frequency output upper limit is 60Hz and frequency setting is also 60Hz, only frequency command will be limit in 60Hz. Actual frequency output may exceed 60Hz after slip compensation.

↗	01-12	Accel. Time 1
↗	01-13	Decel. Time 1
↗	01-14	Accel. Time 2
↗	01-15	Decel. Time 2
↗	01-16	Accel. Time 3
↗	01-17	Decel. Time 3
↗	01-18	Accel. Time 4
↗	01-19	Decel. Time 4
↗	01-20	JOG Acceleration Time
↗	01-21	JOG Deceleration Time

Factory Setting: 10.00/10.0

Settings Pr.01-45=0: 0.00~600.00 seconds

Pr.01-45=1: 0.00~6000.00 seconds

460V, 22kW and above series: 60.00 / 60.0

- 📖 The Acceleration Time is used to determine the time required for the AC motor drive to ramp from 0Hz to Maximum Output Frequency (Pr.01-00).
- 📖 The Deceleration Time is used to determine the time require for the AC motor drive to decelerate from the Maximum Output Frequency (Pr.01-00) down to 0Hz.
- 📖 The Acceleration/Deceleration Time is invalid when using Pr.01-44 Optimal Acceleration/Deceleration Setting.
- 📖 The Acceleration/Deceleration Time 1, 2, 3, 4 are selected according to the Multi-function Input Terminals settings. The factory settings are Accel./Decel. time 1.
- 📖 When enabling torque limits and stalls prevention function, actual accel./decel. time will be longer than the above action time.
- 📖 Please note that it may trigger the protection function (Pr.06-03 Over-current Stall Prevention during Acceleration or Pr.06-01 Over-voltage Stall Prevention) when setting of accel./decel. time is too short.
- 📖 Please note that it may cause motor damage or drive protection enabled due to over current during acceleration when the setting of acceleration time is too short.
- 📖 Please note that it may cause motor damage or drive protection enabled due to over current during deceleration or over-voltage when the setting of deceleration time is too short.
- 📖 It can use suitable brake resistor (see Chapter 07 Accessories) to decelerate in a short time and prevent over-voltage.
- 📖 When enabling Pr.01-24~Pr.01-27, the actual accel./decel. time will be longer than the setting.

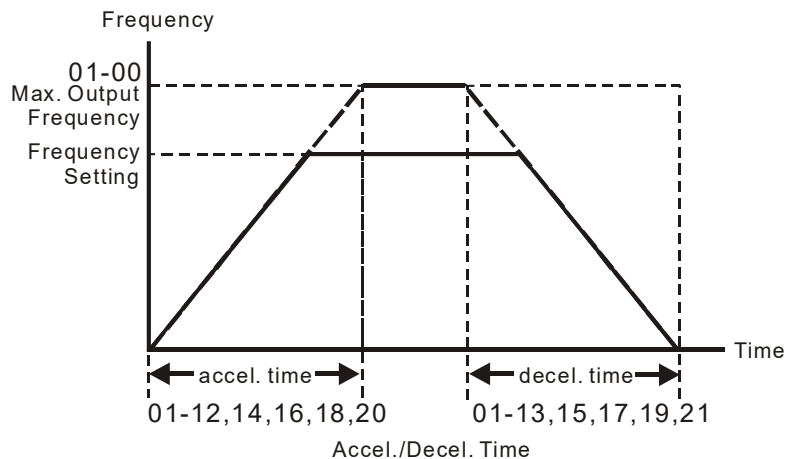

➤ **01-22** JOG Frequency

Factory Setting: 6.00

Settings 0.00~599.00Hz

- 📖 Both external terminal JOG and key “F1” on the keypad KPC-CC02 can be used. When the JOG command is ON, the AC motor drive will accelerate from 0Hz to JOG frequency (Pr.01-22). When the JOG command is OFF, the AC motor drive will decelerate from JOG Frequency to zero. The JOG Accel./Decel. time (Pr.01-20, Pr.01-21) is the time that accelerates from 0.0Hz to Pr.01-22 JOG Frequency.
- 📖 The JOG command can't be executed when the AC motor drive is running. In the same way, when the JOG command is executing, other operation commands are invalid.
- 📖 It does not support JOG function in the optional keypad KPC-CC02.

➤ **01-23** 1st/4th Accel./decel. Frequency

Factory Setting: 0.00

Settings 0.00~599.00Hz

- 📖 The transition from acceleration/deceleration time 1 to acceleration/deceleration time 4, may also be enabled by the external terminals. The external terminal has priority over Pr. 01-23.
- 📖 When using this function, please set S-curve acceleration time as 0 if 4th acceleration time is set too short.

As the usage of Pr.01-23, for instance, under Pr.01-00=80Hz and Pr.01-23=40Hz:

- a. If Pr.01-02=10s, Pr.01-18=6s, then the 0~40Hz Acc. Time will be around 3s and 40~80Hz Acc. Time will be around 5s at acceleration.
- b. If Pr.01-13=8s, Pr.01-19=2s, then 80~40Hz Dec. Time will be around 4s and 40~0Hz Dec. Time will be around 1s at deceleration.

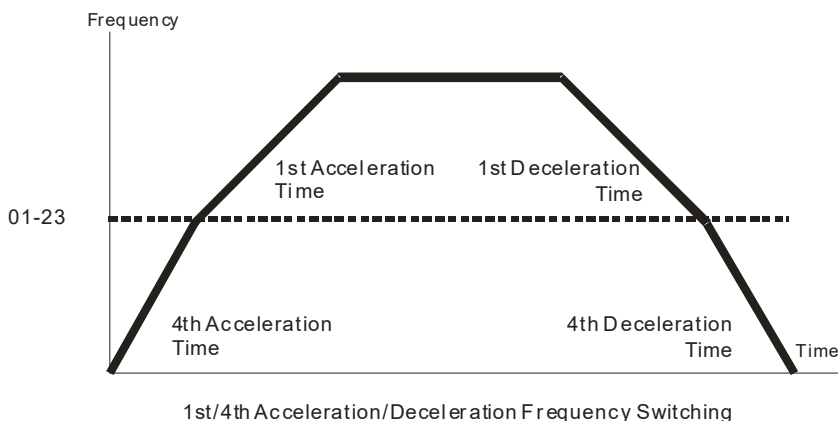

➤ **01-24** S-curve Acceleration Begin Time 1

➤ **01-25** S-curve Acceleration Arrival Time 2

➤ **01-26** S-curve Deceleration Begin Time 1

➤ **01-27** S-curve Deceleration Arrival Time 2

Factory Setting: 0.20/0.2

Settings Pr.01-45=0: 0.00~25.00 seconds

Pr.01-45=1: 0.00~250.0 seconds

- 📖 It is used to give the smoothest transition between speed changes. The accel./decel. curve can adjust the S-curve of the accel./decel. When it is enabled, the drive will have different accel./decel.

- 📖 It is used to give the smoothest transition between speed changes. The accel./decel. curve can adjust the S-curve of the accel./decel. When it is enabled, the drive will have different accel./decel. curve by the accel./decel. time.
- 📖 The S-curve function is disabled when accel./decel. time is set to 0.
- 📖 When Pr.01-12, 01-14, 01-16, 01-18 ≥ Pr.01-24 and Pr.01-25,
The Actual Accel. Time = Pr.01-12, 01-14, 01-16, 01-18 + (Pr.01-24 + Pr.01-25)/2
- 📖 When Pr.01-13, 01-15, 01-17, 01-19 ≥ Pr.01-26 and Pr.01-27,
The Actual Decel. Time = Pr.01-13, 01-15, 01-17, 01-19 + (Pr.01-26 + Pr.01-27)/2

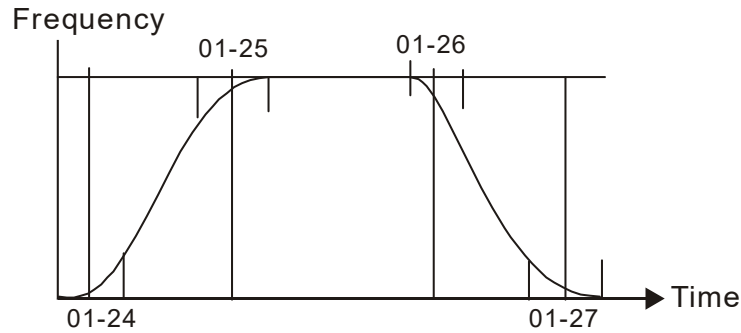

01-28	Skip Frequency 1 (upper limit)
01-29	Skip Frequency 1 (lower limit)
01-30	Skip Frequency 2 (upper limit)
01-31	Skip Frequency 2 (lower limit)
01-32	Skip Frequency 3 (upper limit)
01-33	Skip Frequency 3 (lower limit)

Factory Setting: 0.00

Settings 0.00~599.00Hz

- 📖 These parameters are used to set the skip frequency of the AC drive. But the frequency output is continuous. There is no limit for the setting of these six parameters and can be used as required.
- 📖 The skip frequencies are useful when a motor has vibration at a specific frequency bandwidth. By skipping this frequency, the vibration will be avoided. It offers 3 zones for use.
- 📖 The setting of frequency command (F) can be set within the range of skip frequencies. In this moment, the output frequency (H) will be limited by these settings.
- 📖 When accelerating/decelerating, the output frequency will still pass the range of skip frequencies.

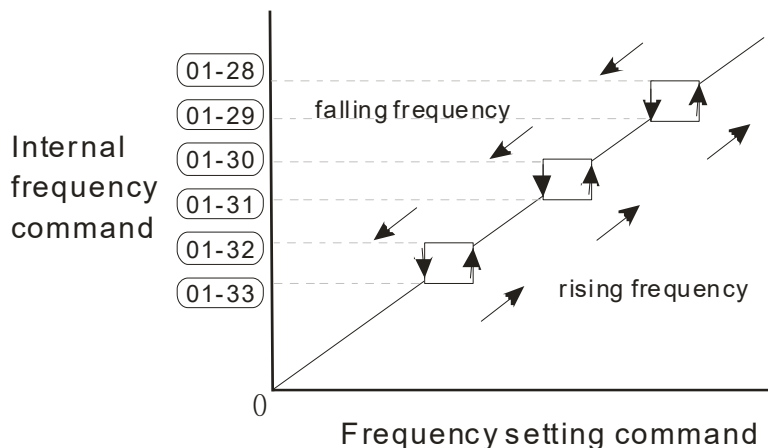

01-34 Zero-speed Mode

Factory Setting: 0

- Settings 0: Output waiting
 1: Zero-speed operation
 2: Fmin (Refer to Pr.01-07, 01-41)

- 📖 When the frequency is less than Fmin (Pr.01-07 or Pr.01-41), it will operate by this parameter.
- 📖 When it is set to 0, the AC motor drive will be in waiting mode without voltage output from terminals U/V/W.
- 📖 When setting 1, it will execute DC brake by Vmin(Pr.01-08 and Pr.01-42) in V/f, and SVC modes.
- 📖 When it is set to 2, the AC motor drive will run by Fmin (Pr.01-07, Pr.01-41) and Vmin (Pr.01-08, Pr.01-42) in V/F, SVC modes.
- 📖 In V/F, SVC modes

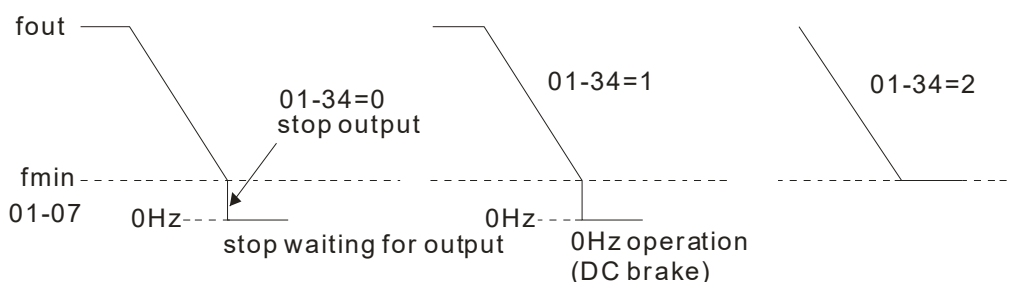
**01-43** V/F Curve Selection

Factory Setting: 0

Settings 0~15

- 📖 V/F curve can be selected from 15 kinds of default settings or set manually.
- 📖 Different kinds of V/F curves are shown in the table below. There are 15 kinds of V/F curve to be chosen. Choose a V/F curve suitable for your application then set Pr01-43 by following the V/F curve chosen. The set values of Pr01-00 ~Pr01-08 can be verified and fine-tuned.

NOTE

1. If the V/F curve is not selected properly, it may result motor to generate insufficient torque or may lead to high current output due to over fluxing.
2. When the motor drive is reset by Pr00-02, Pr01-43 is reset as well.

Setting	SPEC.	Feature	Purpose
0	V/F curve determined (Pr.01-00~01-08)	Constant torque	For normal application, it is used when the torque of load is firm, and it will not be affected by the rotor speed of motor.
1	1.5 th V/F curve	Variable torque	When setting higher power V/F curve, it is lower torque at low frequency and is not suitable for rapid acceleration/deceleration. It is recommended NOT to use this parameter for the rapid acceleration/deceleration.
2	2 nd V/F curve		
3	60Hz (voltage saturation in 50Hz)	Constant torque	For normal application, it is used when the torque of load is firm, and it will not be affected by the rotor speed of motor.
4	72Hz (voltage saturation in 60Hz)		
5	3 rd decreasing (50Hz)	Decreasing torque	For fans, pumps, the required torque derating relative to the load.
6	2 nd decreasing (50Hz)		
7	3 rd decreasing (60Hz)		
8	2 nd decreasing (60Hz)		

Setting	SPEC.	Feature	Purpose
9	Mid. Starting torque (50Hz)	High starting torque	Select high starting torque when: <ul style="list-style-type: none"> ■ Wiring between the drive and motor(exceeds 150 m) ■ A large amount of starting torque is required (like lift) ■ An AC reactor is installed in the output side of the drive
10	High starting torque (50Hz)		
11	Mid. Starting torque (60Hz)		
12	High starting torque (60Hz)		
13	90Hz (voltage saturation in 60Hz)	Constant output operation	The curve for operation above 60Hz. To operate above 60Hz, the output voltage is fixed.
14	120Hz (voltage saturation in 60Hz)		
15	180Hz (voltage saturation in 60Hz)		

- 📖 When setting to 0, refer to Pr.01-01~01-08 for motor 1 V/F curve. For motor 2, please refer to Pr.01-35~01-42.
- 📖 When setting to 1 or 2, 2nd and 3rd voltage frequency setting are invalid.
- 📖 When setting higher power V/F curve, it is lower torque at low frequency and is not suitable for rapid acceleration/deceleration. It is recommended NOT to use this parameter for the rapid acceleration/deceleration.

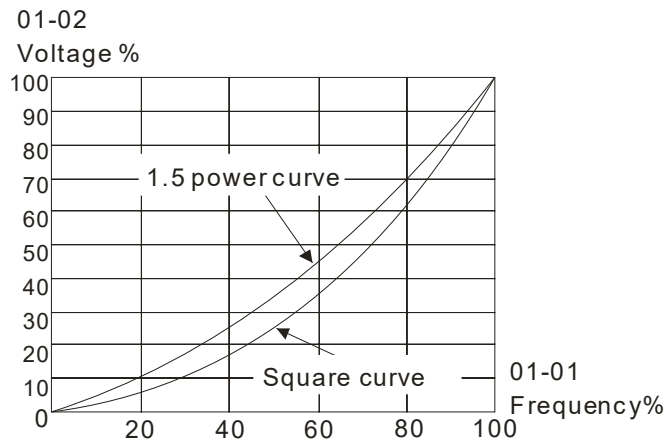

🚩 **01-44** Optimal Acceleration/Deceleration Setting

Factory Setting: 0

- Settings
- 0: Linear accel./decel.
 - 1: Auto accel., linear decel.
 - 2: Linear accel., auto decel.
 - 3: Auto accel./decel. (auto calculate the accel./decel. time by actual load)
 - 4: Stall prevention by auto accel./decel. (limited by 01-12 to 01-21)

- 📖 This setting could effectively reduce mechanical vibration from load start-up and stop: it can automatically detect small torque, and accelerate to required frequency with fastest speed and the smoothest start-up current. For deceleration, it evaluates the returned energy from the load, and stop the motor in the shortest time.
- 📖 Setting 0 Linear accel./decel.: it will accelerate/decelerate according to the setting of Pr.01-12~01-19.
- 📖 Setting to Auto accel./decel.: it can reduce the mechanical vibration and prevent the complicated auto-tuning processes. It won't stall during acceleration and no need to use brake resistor. In addition, it can improve the operation efficiency and save energy.

- Setting 3 Auto accel./decel. (auto calculate the accel./decel. time by actual load): it can auto detect the load torque and accelerate from the fastest acceleration time and smoothest start current to the setting frequency. In the deceleration, it can auto detect the load re-generation and stop the motor smoothly with the fastest decel. time.
- Setting 4 Stall prevention by auto accel./decel. (limited by 01-12 to 01-21): if the acceleration/deceleration is in the reasonable range, it will accelerate/decelerate by Pr.01-12~01-19. If the accel./decel. time is too short, the actual accel./decel. time is greater than the setting of accel./decel. time.

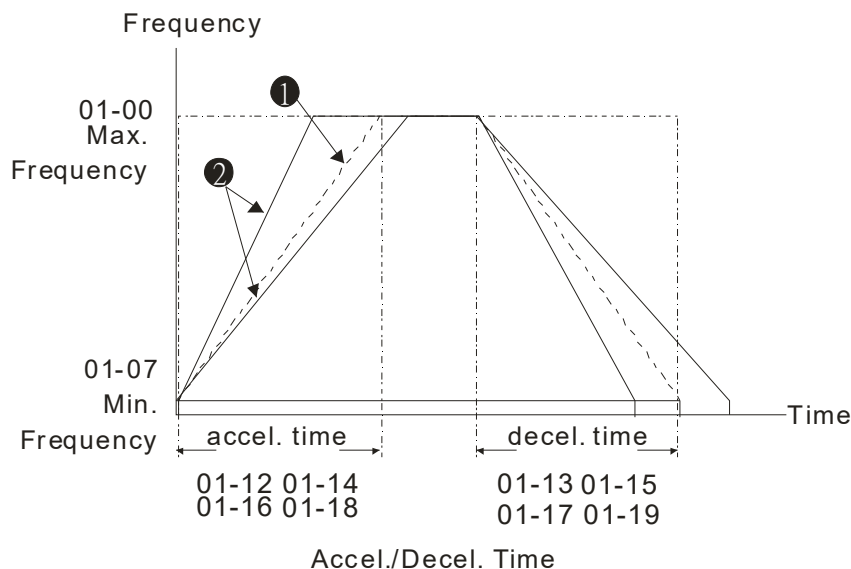

- ① When Pr.01-44 is set to 0.
- ② When Pr.01-44 is set to 3.

01-45 Time Unit for Acceleration/Deceleration and S Curve

Factory Setting: 0

- Settings 0: Unit 0.01 sec
- 1: Unit 0.1 sec

01-46 Time for CANopen Quick Stop

Factory Setting: 1.00

- Settings Pr. 01-45=0: 0.00~600.00 sec
- Pr. 01-45=1: 0.0~6000.0 sec

It is used to set the time that decelerates from the max. operation frequency (Pr.01-00) to 0.00Hz in CANopen control.

01-49 Deceleration Method

Factory Setting: 0

- Settings 0: Normal decel.
- 1: Over fluxing decel.
- 2: Traction energy control

- When Pr01-49=0, the deceleration or stop will according to original deceleration method.
- When Pr01-49=1: drive will control the deceleration time according to the Pr06-01 setting value and DC BUS voltage.
DC BUS >95% of Pr06-01 Over-voltage Stall Prevention setting value →enable Over fluxing

deceleration method.

If the Pr06-01=0→Drive will enable Over fluxing deceleration method according to the operating voltage and DC BUS regenerative voltage. This method will refer to the deceleration time setting and the actual deceleration time will be longer than the deceleration time setting.

- 📖 Actual deceleration time will be longer than the deceleration time setting because of the Over-voltage Stall Prevention function.
- 📖 When Pr01-49=1, please use with the parameter Pr06-02=1 to get a better over-voltage suppression effect during deceleration.
- 📖 Pr01-49=2: this function is based on the drives' ability to auto-adjust output frequency and voltage in order to get faster DC BUS energy consumption and the actual deceleration time will be as much as possible consistent with the deceleration parameter set up time. When real deceleration time does not conform to the expected deceleration time and cause an over-voltage error, recommended to use this setting.

02 Digital Input/Output Parameter

✎ This parameter can be set during operation.

02-00 2-wire/3-wire Operation Control

Factory Setting: 0

- Settings 0: 2 wire mode 1
 1: 2 wire mode 2
 2: 3 wire mode

📖 It is used to set the operation control method:

Pr.02-00	Control Circuits of the External Terminal
0 2-wire mode 1 FWD/STOP REV/STOP	
1 2-wire mode 2 RUN/STOP FWD/REV REV/FWD	
2 3-wire operation control	

02-01 Multi-function Input Command 1 (MI1)
 (MI1= STOP command when in 3-wire operation control)

Factory Setting: 1

02-02 Multi-function Input Command 2 (MI2)

Factory Setting: 2

02-03 Multi-function Input Command 3 (MI3)

Factory Setting: 3

02-04 Multi-function Input Command 4 (MI4)

Factory Setting: 4

02-05 Multi-function Input Command 5 (MI5)

02-06 Multi-function Input Command 6 (MI6)

02-07 Multi-function Input Command 7 (MI7)

02-08 Multi-function Input Command 8 (MI8)

02-26 Input terminal of I/O extension card (MI10)

02-27 Input terminal of I/O extension card (MI11)

02-28 Input terminal of I/O extension card (MI12)

02-29	Input terminal of I/O extension card (MI13)
02-30	Input terminal of I/O extension card (MI14)
02-31	Input terminal of I/O extension card (MI15)

Factory Setting: 0

Settings 0~69 (See below summary of function settings)

- 📖 This parameter selects the functions for each multi-function terminal.
- 📖 The terminals of Pr.02-26~Pr.02-29 are virtual and set as MI10~MI13 when using with optional card EMC-D42A. Pr.02-30~02-31 are virtual terminals.
- 📖 When being used as a virtual terminal, it needs to change the status (0/1: ON/OFF) of bit 8-15 of Pr.02-12 by digital keypad KPC-CC02 or communication.
- 📖 If Pr.02-00 is set to 3-wire operation control. Terminal MI1 is for STOP contact. Therefore, MI1 is not allowed for any other operation.
- 📖 Summary of function settings (Take the normally open contact for example, ON: contact is closed, OFF: contact is open)

Settings	Functions	Descriptions
0	No Function	
1	Multi-step speed command 1/ multi-step position command 1	15 step speeds could be conducted through the digital status of the 4 terminals, and 16 in total if the master speed is included. (Refer to Parameter set 4)
2	Multi-step speed command 2/ multi-step position command 2	
3	Multi-step speed command 3/ multi-step position command 3	
4	Multi-step speed command 4/ multi-step position command 4	
5	Reset	After the error of the drive is eliminated, use this terminal to reset the drive.
6	JOG Command	This function is valid when the source of operation command is external terminals. Before executing this function, it needs to wait for the drive stop completely. During running, it can change the operation direction and STOP key on the keypad is valid. Once the external terminal receives OFF command, the motor will stop by the JOG deceleration time. Refer to Pr.01-20~01-22 for details.

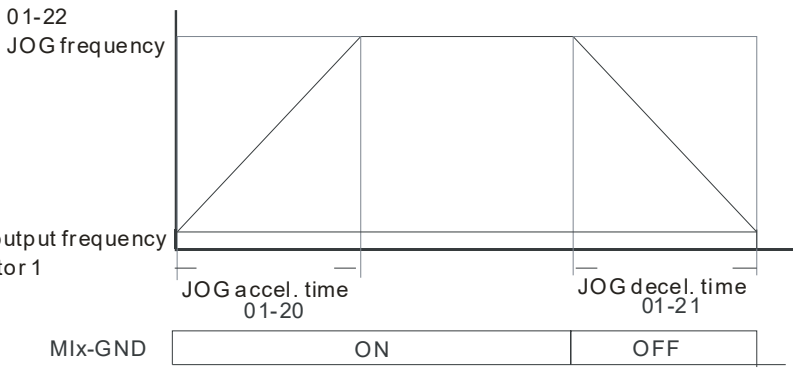
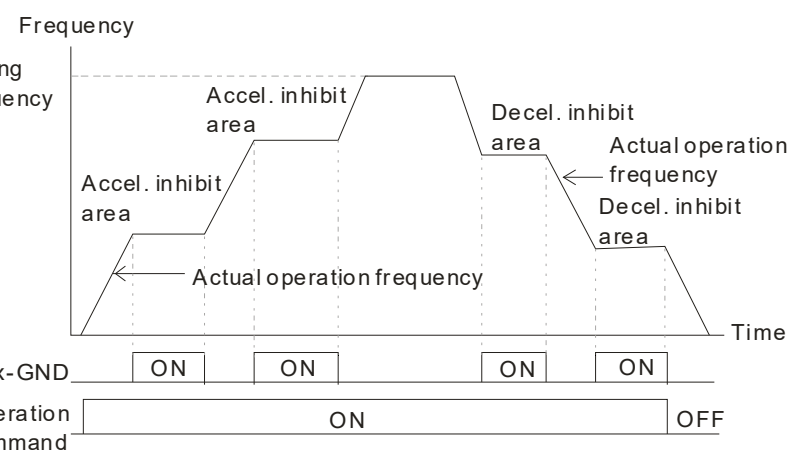
Settings	Functions	Descriptions															
		<p>01-22 JOG frequency</p>  <p>01-07 Min. output frequency of motor 1</p> <p>JOG accel. time 01-20</p> <p>JOG decel. time 01-21</p> <p>Mix-GND ON OFF</p>															
7	Acceleration/deceleration Speed Inhibit	<p>When this function is enabled, acceleration and deceleration is stopped. After this function is disabled, the AC motor drive starts to accel./decel. from the inhibit point.</p>  <p>Frequency</p> <p>Setting frequency</p> <p>Accel. inhibit area</p> <p>Decel. inhibit area</p> <p>Actual operation frequency</p> <p>Time</p> <p>Mix-GND ON ON ON ON</p> <p>Operation command ON OFF</p>															
8	The 1 st , 2 nd acceleration or deceleration time selection	<p>The acceleration/deceleration time of the drive could be selected from this function or the digital status of the terminals; there are 4 acceleration / deceleration speeds in total for selection.</p>															
9	The 3 rd , 4 th acceleration or deceleration time selection	<table border="1" data-bbox="826 1335 1342 1581"> <thead> <tr> <th>Mlx=9</th> <th>Mlx=8</th> <th>Accel./Decel.</th> </tr> </thead> <tbody> <tr> <td>OFF</td> <td>OFF</td> <td>1st Accel./Decel.</td> </tr> <tr> <td>OFF</td> <td>ON</td> <td>2nd Accel./Decel.</td> </tr> <tr> <td>ON</td> <td>OFF</td> <td>3rd Accel./Decel.</td> </tr> <tr> <td>ON</td> <td>ON</td> <td>4th Accel./Decel.</td> </tr> </tbody> </table>	Mlx=9	Mlx=8	Accel./Decel.	OFF	OFF	1st Accel./Decel.	OFF	ON	2 nd Accel./Decel.	ON	OFF	3 rd Accel./Decel.	ON	ON	4 th Accel./Decel.
Mlx=9	Mlx=8	Accel./Decel.															
OFF	OFF	1st Accel./Decel.															
OFF	ON	2 nd Accel./Decel.															
ON	OFF	3 rd Accel./Decel.															
ON	ON	4 th Accel./Decel.															
10	EF Input (EF: External fault)	<p>For external fault input. Motor drive will decelerate by Pr.07-20 setting, keypad will show EF. (It will have fault record when external fault occurs). Until the causes of fault are eliminated, the drive can keep running after resetting.</p>															
11	External B.B. Input (Base Block)	<p>When the contact of this function is ON, output of the drive will be cut off immediately, and the motor will be free run and keypad will display B.B. signal. Refer to Pr.07-08 for details.</p>															

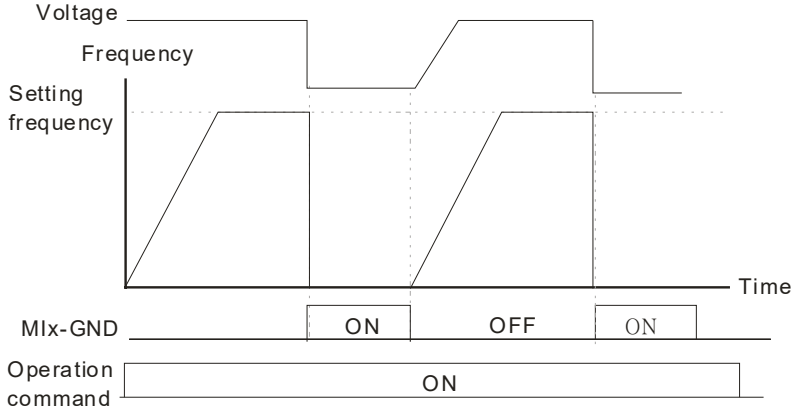
Settings	Functions	Descriptions
12	Output Stop (Output pause)	<p>If the contact of this function is ON, output of the drive will be cut off immediately, and the motor will then be free run. And once it is turned to OFF, the drive will accelerate to the setting frequency.</p>  <p>Mlx-GND: ON OFF ON</p> <p>Operation command: ON</p>
13	Cancel the setting of the optimal accel./decel. time	<p>Before using this function, Pr.01-44 should be set to 01/02/03/04 first. When this function is enabled, OFF is for auto mode and ON is for linear accel./decel.</p>
14	Switch between drive settings 1 and 2	<p>When the contact of this function is ON: use motor 2 parameters. OFF: use motor 1 parameters.</p>
15	Operation speed command form AVI1	<p>When the contact of this function is ON, the source of the frequency will force to be AVI1. (If the operation speed commands are set to AVI1, ACI and AVI2 at the same time. The priority is AVI1 > ACI > AVI2)</p>
16	Operation speed command form ACI	<p>When the contact of this function is ON, the source of the frequency will force to be ACI. (If the operation speed commands are set to AVI1, ACI and AVI2 at the same time. The priority is AVI1 > ACI > AVI2)</p>
17	Operation speed command form AVI2	<p>When the contact of this function is ON, the source of the frequency will force to be AVI2. (If the operation speed commands are set to AVI1, ACI and AVI2 at the same time. The priority is AVI1 > ACI > AVI2)</p>
18	Emergency Stop (07-20)	<p>When the contact of this function is ON, the drive will ramp to stop by Pr.07-20 setting.</p>
19	Digital Up command	<p>When the contact of this function is ON, the frequency will be increased and decreased. If this function is constantly ON, the frequency will be increased/decreased by Pr.02-09/Pr.02-10.</p>
20	Digital Down command	<p>The frequency command returns to zero when the drive stops, and the display frequency is 0.00Hz. Select Pr11-00, Bit7=1, frequency is not saved.</p>
21	PID function disabled	<p>When the contact of this function is ON, the PID function is disabled.</p>
22	Clear counter	<p>When the contact of this function is ON, it will clear current counter value and display "0". Only when this function is disabled, it will keep counting upward.</p>

Settings	Functions	Descriptions															
23	Input the counter value (multi-function input command 6)	The counter value will increase 1 once the contact of this function is ON. It needs to be used with Pr.02-19.															
24	FWD JOG command	When the contact is ON, the drive will execute forward Jog command.															
25	REV JOG command	When the contact is ON the drive will execute reverse Jog command.															
28	Emergency stop (EF1)	<p>When the contact is ON, the drive will execute emergency stop and display EF1 on the keypad. The motor won't run and be in the free run until the fault is cleared after pressing RESET" (EF: External Fault)</p> <p>The diagram shows the drive's response to an emergency stop signal. It includes waveforms for Voltage, Frequency, Setting frequency, Mix-GND, Reset, and Operation command over Time. The Mix-GND signal transitions from OFF to ON, causing the drive to stop. After the Reset signal transitions from OFF to ON, the drive resumes operation.</p>															
29	Signal confirmation for Y-connection	When is the contact of this function is ON, the drive will operate by 1st V/F.															
30	Signal confirmation for Δ-connection	When the contact of this function is ON, the drive will operate by 2nd V/F.															
38	Disable EEPROM write function (Parameters written disable)	When the contact of this function is ON, write to EEPROM is disabled. (Changed parameters will not be saved after power off)															
40	Force coast to stop	When the contact of this function is ON during the operation, the drive will free run to stop.															
41	HAND switch	1. When MI is switched to off status, it executes a STOP command. , If MI is switched to off during operation, the drive will also stop.															
42	AUTO switch	<p>2. Using keypad KPC-CC02 to switch between HAND/AUTO, the drive will stop first then switch to the HAND or AUTO status.</p> <p>3. On the digital keypad KPC-CC02, it will display current drive status (HAND/OFF/AUTO).</p> <table border="1" style="margin-left: auto; margin-right: auto;"> <thead> <tr> <th></th> <th>Bit 1</th> <th>Bit 0</th> </tr> </thead> <tbody> <tr> <td>OFF</td> <td>0</td> <td>0</td> </tr> <tr> <td>AUTO</td> <td>0</td> <td>1</td> </tr> <tr> <td>HAND</td> <td>1</td> <td>0</td> </tr> <tr> <td>OFF</td> <td>1</td> <td>1</td> </tr> </tbody> </table>		Bit 1	Bit 0	OFF	0	0	AUTO	0	1	HAND	1	0	OFF	1	1
	Bit 1	Bit 0															
OFF	0	0															
AUTO	0	1															
HAND	1	0															
OFF	1	1															

Settings	Functions	Descriptions															
49	Drive enable	When drive=enable, RUN command is valid. When drive= disable, RUN command is invalid. When drive is in operation, motor coast to stop. This function will interact with MO=51															
50	Slave dEb action to execute	Input the message setting in this parameter when dEb occurs to Master. This will ensure dEb also occurs to Slave, then Master and Slave will stop simultaneously.															
51	Selection for PLC mode bit0	<table border="1"> <thead> <tr> <th>PLC status</th> <th>Bit 1</th> <th>Bit 0</th> </tr> </thead> <tbody> <tr> <td>Disable PLC function (PLC 0)</td> <td>0</td> <td>0</td> </tr> <tr> <td>Trigger PLC to operation (PLC 1)</td> <td>0</td> <td>1</td> </tr> <tr> <td>Trigger PLC to stop (PLC 2)</td> <td>1</td> <td>0</td> </tr> <tr> <td>No function</td> <td>1</td> <td>1</td> </tr> </tbody> </table>	PLC status	Bit 1	Bit 0	Disable PLC function (PLC 0)	0	0	Trigger PLC to operation (PLC 1)	0	1	Trigger PLC to stop (PLC 2)	1	0	No function	1	1
PLC status	Bit 1	Bit 0															
Disable PLC function (PLC 0)	0	0															
Trigger PLC to operation (PLC 1)	0	1															
Trigger PLC to stop (PLC 2)	1	0															
No function	1	1															
52	Selection for PLC mode bit1																
53	Trigger CANopen quick stop	When this function is enabled under CANopen control, it will change to quick stop. Refer to Chapter 15 for more details.															
54	UVW Output Electromagnetic Valve Switch	To receive confirmation signals while there is UVW magnetic contactor during output.															
55	Brake release	This parameter needs to be used with P02-56. The main purpose is to make sure if mechanical brake works or not after triggering brake release command. If the action is right, mechanical brake will give signal to MI terminal. Please check time sequence chart for reference.															
56	LOCAL/REMOTE Selection	Use Pr.00-29 to select for LOCAL/REMOTE mode (refer to Pr.00-29). When Pr.00-29 is not set to 0, on the digital keypad KPC-CC02 it will display LOC/REM status. (It will display on the KPC-CC02 if the firmware version is above version 1.021). <table border="1"> <thead> <tr> <th></th> <th>Bit 0</th> </tr> </thead> <tbody> <tr> <td>REM</td> <td>0</td> </tr> <tr> <td>LOC</td> <td>1</td> </tr> </tbody> </table>		Bit 0	REM	0	LOC	1									
	Bit 0																
REM	0																
LOC	1																
58	Enable fire mode with RUN Command	Enable this function under fire mode to force the drive to run with forward or reverse direction (while there is RUN COMMAND).															
59	Enable fire mode without RUN Command	Enable this function under fire mode to force the drive to run (while there isn't RUN COMMAND).															
60	Disable all the motors	When the multi-motor circulative control is enable, all motors will park freely, when the function terminal set to be ON.															
61	Disable Motor#1	These functions work with multi-motor circulative control, motor #1 to # 8 can be set to park freely. If any of Auxiliary Motor#1 to Motor#8 is out of order or under maintenance, enable this terminal to bypass that motor.															
62	Disable Motor#2																
63	Disable Motor#3																
64	Disable Motor#4																
65	Disable Motor#5																
66	Disable Motor#6																
67	Disable Motor#7																
68	Disable Motor#8																

Settings	Functions	Descriptions
69	Preheating Command	When the function terminal is setting to ON, if the preheating function is open and drive is in STOP status, the preheating function is executed; until the contact status (OFF) or drive status is turned to RUN, the preheating function is stop. Please refer to Pr.02-72~73 for detail.

✎ **02-09** UP/DOWN Key Mode Factory Setting: 0

Settings 0: Up/down by the accel/decel time
 1: Up/down constant speed (Pr.02-10)

✎ **02-10** Constant speed. The Accel. /Decel. Speed of the UP/DOWN Key Factory Setting: 0.001

Settings 0.001~1.000Hz/ms

- 📖 These settings are used when multi-function input terminals are set to 19/20. Refer to Pr.02-09 and 02-10 for the frequency up/down command.
- 📖 Pr11-00, Bit7=1, frequency command is not saved. The frequency command returns to zero when the drive stops, and the display frequency is 0.00Hz. The frequency command increase/decrease by using Up/Down key is effective only when the drive is at Running status.
- 📖 Pr.02-09 set to 0: it will increase/decrease frequency command (F) by the setting of acceleration/deceleration (Pr.01-12~01-19)

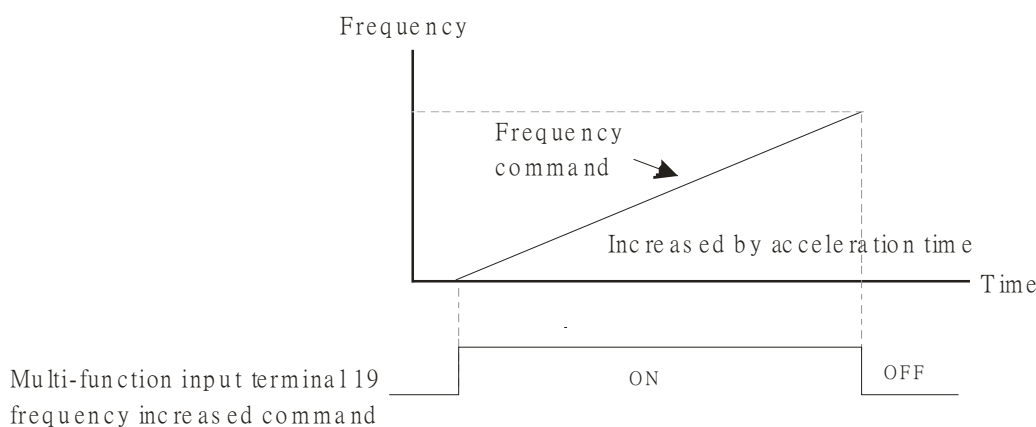

- 📖 Pr.02-09 set to 1: use multi-function input terminal ON/OFF to increase/decrease the frequency command (F) according to the setting of Pr.02.10 (0.01~1.00Hz/ms).

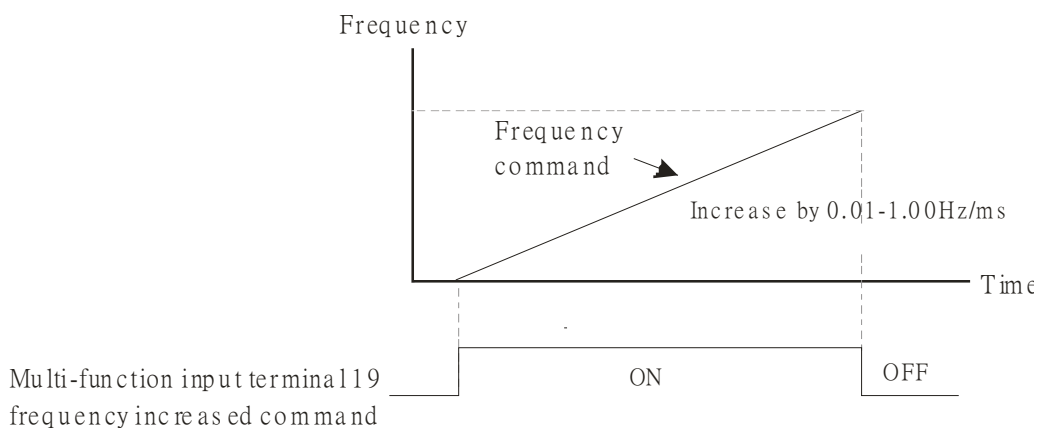

➤ **02-11** Digital Input Response Time

Factory Setting: 0.005

Settings 0.000~30.000 sec

- 📖 This parameter is used to set the response time of digital input terminals FWD, REV and MI1~MI8.
- 📖 It is used for digital input terminal signal delay and confirmation. The delay time is confirmation time to prevent some uncertain interference that would cause error in the input of the digital terminals. Under this condition, confirmation for this parameter would improve effectively, but the response time will be somewhat delayed.
- 📖 When using MI8 as encoder pulse feedback input, this parameter will not be referred.

➤ **02-12** Digital Input Operation Setting

Factory Setting: 0000h

Settings 0000h~FFFFh (0: N.O ; 1: N.C)

- 📖 The setting of this parameter is in hexadecimal.
- 📖 This parameter is to set the status of multi-function input signal (0: Normal Open ; 1: Normal Close) and it is not affected by the SINK/SOURCE status.
- 📖 Bit0 is for FWD terminal, bit1 is for REV terminal and Bit2 to Bit15 is for MI1 to MI14.
- 📖 User can change terminal status by communicating.

For example, MI1 is set to 1 (multi-step speed command 1), MI2 is set to 2 (multi-step speed command 2). Then the forward + 2nd step speed command=1001(binary)=9 (Decimal).

Pr.02-12=9 needs to be set by communication to run forward with 2nd step speed. No need to wire any multi-function terminal.

Bit15	Bit14	Bit13	Bit12	Bit11	Bit10	Bit9	Bit8	Bit7	Bit6	Bit5	Bit4	Bit3	Bit2	Bit1	Bit0
MI14	MI13	MI12	MI11	MI10	MI9	MI8	MI7	MI6	MI5	MI4	MI3	MI2	MI1	REV	FWD

➤ **02-13** Multi-function Output 1 (Relay1)

Factory Setting: 11

➤ **02-14** Multi-function Output 2 (Relay2)

Factory Setting: 1

➤ **02-15** Multi-function Output 3 (Relay3)

Factory Setting: 66

➤ **02-36** Output terminal of I/O extension card (MO10) or (RA10)

➤ **02-37** Output terminal of I/O extension card (MO11) or (RA11)

➤ **02-38** Output terminal of I/O extension card (MO12) or (RA12)

➤ **02-39** Output terminal of I/O extension card (MO13) or (RA13)

➤ **02-40** Output terminal of I/O extension card (MO14) or (RA14)

➤ **02-41** Output terminal of I/O extension card (MO15) or (RA15)

➤ **02-42** Output terminal of I/O extension card (MO16)

➤ **02-43** Output terminal of I/O extension card (MO17)

➤ **02-44** Output terminal of I/O extension card (MO18)

➤ **02-45** Output terminal of I/O extension card (MO19)

02-46 Output terminal of I/O extension card (MO20)

Factory Setting: 0

Settings 0~69 (See below summary of function settings)

- 📖 This parameter is used for setting the function of multi-function terminals.
- 📖 Pr.02-36~Pr.02-41 requires additional extension cards to display the parameters, the choices of optional cards are EMC-D42A and EMC-R6AA.
- 📖 The optional card EMC-D42A provides 2 output terminals and can be used with Pr.02-36~02-37.
- 📖 The optional card EMC-R6AA provides 6 output terminals and can be used with Pr.02-36~02-41.
- 📖 Summary of function settings (Take the normally open contact for example, ON: contact is closed, OFF: contact is open)

Settings	Functions	Descriptions
0	No Function	
1	Operation Indication	Active when the drive is not at STOP.
2	Master Frequency Attained	Active when the AC motor drive reaches the output frequency setting.
3	Desired Frequency Attained 1 (Pr.02-22)	Active when the desired frequency (Pr.02-22) is attained.
4	Desired Frequency Attained 2 (Pr.02-24)	Active when the desired frequency (Pr.02-24) is attained.
5	Zero Speed (frequency command)	Active when frequency command =0. (the drive should be at RUN mode)
6	Zero Speed with Stop (frequency command)	Active when frequency command =0 or stop.
7	Over Torque 1	Active when detecting over-torque. Refer to Pr.06-07 (over-torque detection level-OT1) and Pr.06-08 (over-torque detection time-OT1). Refer to Pr.06-06~06-08.
8	Over Torque 2	Active when detecting over-torque. Refer to Pr.06-10 (over-torque detection level-OT2) and Pr.06-11 (over-torque detection time-OT2). Refer to Pr.06-09~06-11.
9	Drive Ready	Active when the drive is ON and no abnormality detected.
10	Low voltage warn (Lv)	Active when the DC Bus voltage is too low. (refer to Pr.06-00 low voltage level)
11	Malfunction Indication	Active when fault occurs (except Lv stop).
12	Mechanical Brake Release (Pr.02-32)	When drive runs after Pr.02-32, it will be ON. This function should be used with DC brake and it is recommended to use contact "b" (N.C).
13	Overheat	Active when IGBT or heat sink overheats to prevent OH turn off the drive. (refer to Pr.06-15)
14	Software Brake Signal Indication	Active when the soft brake function is ON. (refer to Pr.07-00)
15	PID Feedback Error	Active when the feedback signal is abnormal.

Settings	Functions	Descriptions
16	Slip Error (oSL)	Active when the slip error is detected.
17	Terminal Count Value Attained (Pr.02-20; not return to 0)	Active when the counter reaches Terminal Counter Value (Pr.02-19). This contact won't active when Pr.02-20>Pr.02-19.
18	Preliminary Counter Value Attained (Pr.02-19; returns to 0)	Active when the counter reaches Preliminary Counter Value (Pr.02-19).
19	External Base Block input (B.B.)	Active when the output of the AC motor drive is shut off during base block.
20	Warning Output	Active when the warning is detected.
21	Over-voltage Warning	Active when the over-voltage is detected.
22	Over-current Stall Prevention Warning	Active when the over-current stall prevention is detected.
23	Over-voltage Stall prevention Warning	Active when the over-voltage stall prevention is detected.
24	Operation Mode Indication	Active when the operation command is controlled by external terminal. (Pr.00-21≠0)
25	Forward Command	Active when the operation direction is forward.
26	Reverse Command	Active when the operation direction is reverse.
27	Output when Current >= Pr.02-33	Active when current is >= Pr.02-33.
28	Output when Current < Pr.02-33	Active when current is < Pr.02-33
29	Output when frequency >= Pr.02-34	Active when frequency is >= Pr.02-34.
30	Output when Frequency < Pr.02-34	Active when frequency is <Pr.02-34.
31	Y-connection for the Motor Coil	Active when PR.05-24=1, when frequency output is lower than Pr.05-23 minus 2Hz, continues longer than 05-25.
32	△ -connection for the Motor Coil	Active when PR.05-24=1, when frequency output is higher than Pr.05-23 plus 2Hz, continues longer than 05-25.
33	Zero Speed (actual output frequency)	Active when the actual output frequency is 0. (the drive should be at RUN mode)
34	Zero Speed with Stop (actual output frequency)	Active when the actual output frequency is 0 or Stop.
35	Error Output Selection 1 (Pr.06-23)	Active when Pr.06-23 is ON.
36	Error Output Selection 2 (Pr.06-24)	Active when Pr.06-24 is ON.

Settings	Functions	Descriptions
37	Error Output Selection 3 (Pr.06-25)	Active when Pr.06-25 is ON.
38	Error Output Selection 4 (Pr.06-26)	Active when Pr.06-26 is ON.
40	Speed Attained (including zero speed)	Active when the output frequency reaches frequency setting or stop.
44	Low Current Output	This function needs to be used with Pr.06-71 ~ Pr.06-73
45	UVW Phase Magnet Contractor ON/ OFF Switch	When the multi-function MI is set to 54 “UVW Phase Magnet Contactor Confirm” action, the contactor will active.
46	Master dEb signal output	When dEb arises at Master, MO will send a dEb signal to Slave. Output the message when dEb occurs to Master. This will ensure that dEb also occurs to Slave. Then Slave will follow the decelerate time of Master to stop simultaneously.
47	Brake Release at Stop	<p>When drive stops, the corresponding multi-function terminal will be ON if the frequency is less than Pr.02-34. After it is ON, it will be OFF when brake delay time exceeds Pr.02-32.</p>

Settings	Functions	Descriptions			
50	Output for CANopen control	Control multi-function output terminals through CANopen. If to control RY2, then the Pr02-14 = 50. The mapping table of the CANopen DO is below:			
		physical terminal	Setting of related parameters	Attribute	Corresponding Index
		RY1	P2-13 = 50	RW	The bit 0 at 2026-41
		RY2	P2-14 = 50	RW	The bit 1 at 2026-41
		MO1	P2-16 = 50	RW	The bit 2 at 2026-41
		MO2	P2-17 = 50	RW	The bit 3 at 2026-41
		MO10	P2-36 = 50	RW	The bit 4 at 2026-41
		RY10			The bit 5 at 2026-41
		MO11	P2-37 = 50	RW	The bit 6 at 2026-41
		RY11			The bit 7 at 2026-41
		RY12	P2-38 = 50	RW	The bit 8 at 2026-41
		RY13	P2-39 = 50	RW	The bit 9 at 2026-41
		RY14	P2-40 = 50	RW	The bit 10 at 2026-41
		RY15	P2-41= 50	RW	The bit 0 at 2026-41
Refer to Chapter 15-3-5 for more information.					
51	Output for InnerCOM Control	For RS485 output.			
52	Output for communication card	For communication output of communication cards (CMC-MOD01, CMC-EIP01, CMC-PN01 and CMC-DN01)			
		Physical terminal	Setting of related parameters	Attribute	Corresponding Address
		RY1	P2-13 = 51	RW	The Bit 0 of 2640
		RY2	P2-14 = 51	RW	The Bit 1 of 2640
		RY3	P2-15 = 51	RW	The Bit 2 of 2640
		MO1	P2-16 = 51	RW	The Bit 3 of 2640
		MO2	P2-17 = 51	RW	The Bit 4 of 2640
		MO3	P2-18 = 51	RW	The Bit 5 of 2640
		MO4	P2-19 = 51	RW	The Bit 6 of 2640
		MO5	P2-20 = 51	RW	The Bit 7 of 2640
		MO6	P2-21 = 51	RW	The Bit 8 of 2640
		MO7	P2-22 = 51	RW	The Bit 9 of 2640
MO8	P2-23 = 51	RW	The Bit 10 of 2640		
53	Fire mode indication	When #58 or #59 is enabled, this function will work.			
54	By pass fire mode indication	When bypass function is enabled in the fire mode, this contact will work.			

Settings	Functions	Descriptions														
55	Motor #1 output	When setting multi-motor circulative function, the multi-function output terminal will automatically set up Pr02-13~Pr02-15 and Pr02-36~Pr02-40 in accordance with Pr12-01's setting.														
56	Motor #2 output															
57	Motor #3 output															
58	Motor #4 output															
59	Motor #5 output															
60	Motor #6 output															
61	Motor #7 output															
62	Motor #8 output															
66	SO contact A (N.O.)	<table border="1"> <thead> <tr> <th rowspan="2">Status of drive</th> <th colspan="2">Status of safety output</th> </tr> <tr> <th>N.O. (MO=66)</th> <th>N.C. (MO=68)</th> </tr> </thead> <tbody> <tr> <td>Normal</td> <td>Broken circuit (Open)</td> <td>Short circuit (Close)</td> </tr> <tr> <td>STO</td> <td>Short circuit (Close)</td> <td>Broken circuit (Open)</td> </tr> <tr> <td>STL1~STL3</td> <td>Short circuit (Close)</td> <td>Broken circuit (Open)</td> </tr> </tbody> </table>	Status of drive	Status of safety output		N.O. (MO=66)	N.C. (MO=68)	Normal	Broken circuit (Open)	Short circuit (Close)	STO	Short circuit (Close)	Broken circuit (Open)	STL1~STL3	Short circuit (Close)	Broken circuit (Open)
Status of drive	Status of safety output															
	N.O. (MO=66)	N.C. (MO=68)														
Normal	Broken circuit (Open)	Short circuit (Close)														
STO	Short circuit (Close)	Broken circuit (Open)														
STL1~STL3	Short circuit (Close)	Broken circuit (Open)														
68	SO contact B (N.C.)															
67	Analog input signal level achieved	Multi-function output terminals operate when analog input signal level is between high level and low level. 03-44: Select the analog signal channel, AV11, ACI, and AV12 which is going to be compared. 03-45: The high level of analog input, factory setting is 50%. 03-46: The low level of analog input, factory setting is 10%. If analog input > 03-45, then multi-function output terminal operates. If analog input < 03-46, then multi-function output terminal stops outputting.														
69	Output Command of Preheating	Active when the preheating is detected.														

02-18 Multi-function Output Setting

Factory Setting: 0000h

Settings 0000h~FFFFh (0:N.O. ; 1:N.C.)

The setting of this parameter is in hexadecimal.

This parameter is set via bit setting. If a bit is 1, the corresponding multi-function output acts in the opposite way.

Example:

If Pr02-13=1 and Pr02-18=0, Relay 1 is ON when the drive runs and is OFF when the drive is stopped.

If Pr02-13=1 and Pr02-18=1, Relay 1 is OFF when the drive runs and is ON when the drive is stopped.

Bit setting

bit15	bit14	bit13	bit12	bit11	bit10	bit9	bit8	bit7	bit6	bit5	bit4	bit3	bit2	bit1	bit0
MO20	MO19	MO18	MO17	MO16	MO15	MO14	MO13	MO12	MO11	MO10	Reserved	RY3	RY2	RY1	

➤ **02-19** Terminal Counting Value Attained (return to 0)

Factory Setting: 0

Settings 0~65500

- 📖 The counter trigger can be set by the multi-function terminal MI6 (set Pr.02-06 to 23). Upon completion of counting, the specified multi-function output terminal will be activated (Pr.02-13~02-14, Pr.02-36, 02-37 is set to 18). Pr.02-19 can't be set to 0.
- 📖 When the display shows c5555, the drive has counted 5,555 times. If display shows c5555●, it means that real counter value is between 55,550 to 55,559.

➤ **02-20** Preliminary Counting Value Attained (not return to 0)

Factory Setting: 0

Settings 0~65500

- 📖 When the counter value counts from 1 and reaches this value, the corresponding multi-function output terminal will be activated, provided one of Pr. 02-13, 02-14, 02-36, 02-37 set to 17 (Preliminary Count Value Setting). This parameter can be used for the end of the counting to make the drive runs from the low speed to stop.

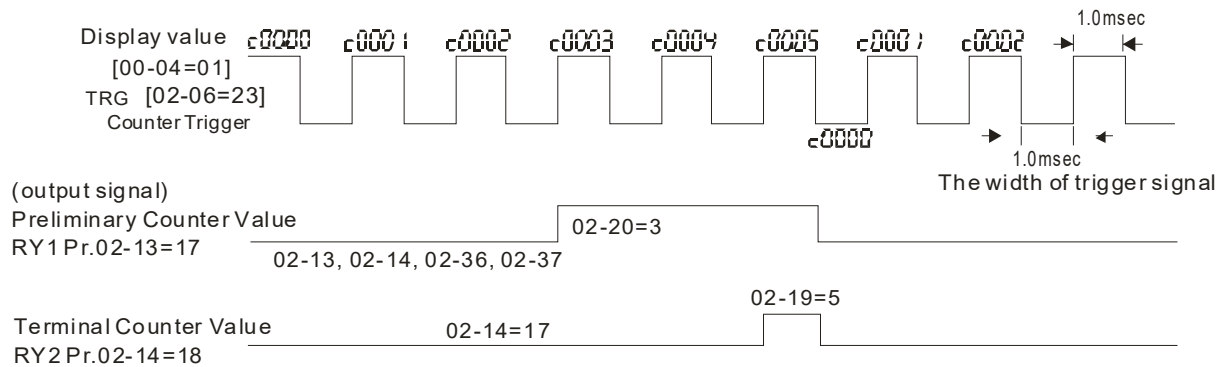

➤ **02-22** Desired Frequency Attained 1

Factory Setting: 60.00/50.00

Settings 0.00~599.00Hz

➤ **02-23** The Width of the Desired Frequency Attained 1

Factory Setting: 2.00

Settings 0.00~599.00Hz

➤ **02-24** Desired Frequency Attained 2

Factory Setting: 60.00/50.00

Settings 0.00~599.00Hz

➤ **02-25** The Width of the Desired Frequency Attained 2

Factory Setting: 2.00

Settings 0.00~599.00Hz

- 📖 Once output frequency reaches desired frequency and the corresponding multi-function output terminal is set to 3 or 4 (Pr.02-13, 02-14, 02-36, and 02-37), this multi-function output terminal will be ON.

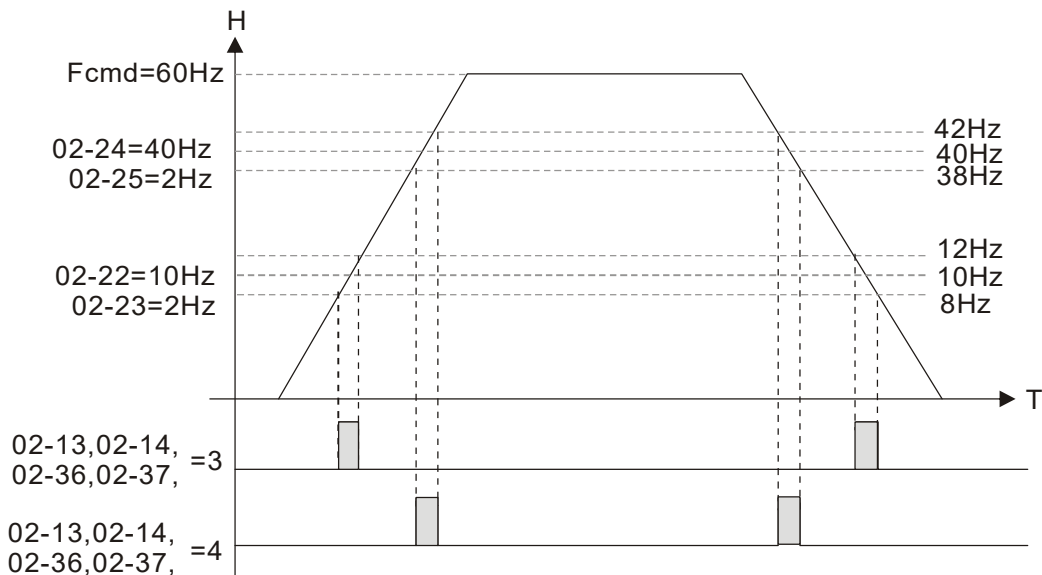

02-32

Brake Delay Time

Factory Setting: 0.000

Settings 0.000~65.000 sec

When the AC motor drive runs after Pr.02-32 delay time, the corresponding multi-function output terminal (12: mechanical brake release) will be ON. It has to use this function with DC brake.

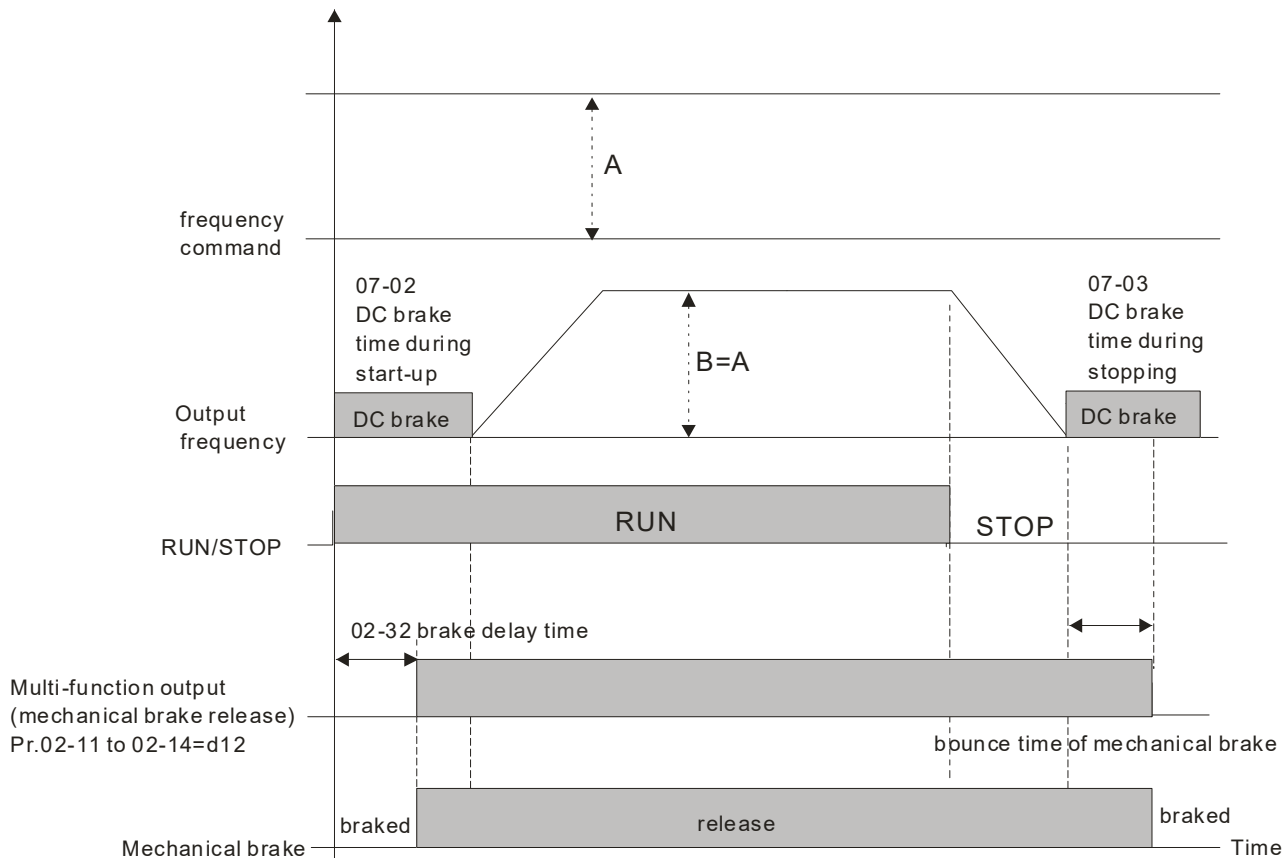

If this parameter is used without DC brake, it will be invalid. Refer to the following operation timing.

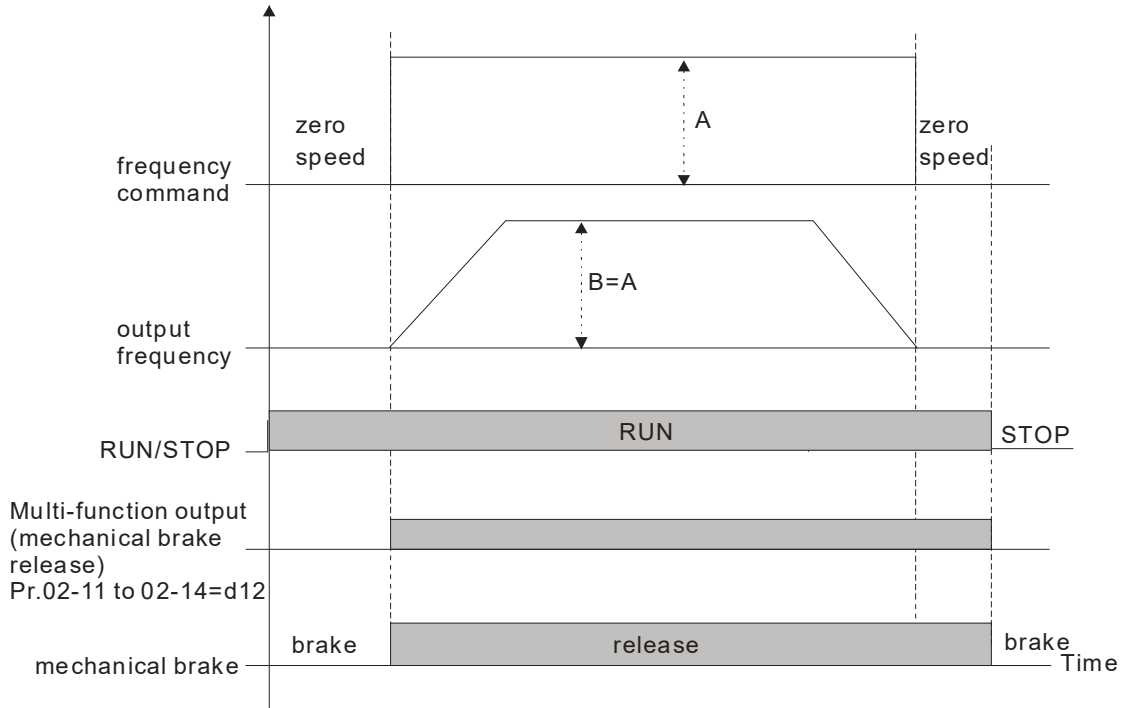

➤ **02-33** Output Current Level Setting for Multi-function Output Terminals

Factory Setting: 0

Settings 0~150%

- 📖 When output current is higher or equal to Pr.02-33, it will activate multi-function output terminal (Pr.02-13, 02-14 and 02-17 is set to 27).
- 📖 When output current is lower or equal to Pr.02-33, it will activate multi-function output terminal (Pr.02-13, 02-14 and 02-17 is set to 28).

➤ **02-34** Output Boundary for Multi-function Output Terminals

Factory Setting: 3.00

Settings 0.00~599.00Hz

- 📖 When output frequency is higher or equal to Pr.02-34, it will activate the multi-function terminal (Pr.02-13, 02-14, 02-16, 02-17 is set to 29).
- 📖 When output frequency is lower or equal to Pr.02-34, it will activate the multi-function terminal (Pr.02-13, 02-14, 02-16, 02-17 is set to 30).

➤ **02-35** External Operation Control Selection after Reset and Activate

Factory Setting: 0

Settings 0: Disable

1: Drive runs if the run command still exists after reset or re-boots.

- 📖 Setting 1: in below situation, the driver will automatically run the command, please pay extra attention.
 - Status 1: After the drive is powered on and the external terminal for RUN keeps ON, the drive will run.
 - Status 2: After clearing fault once a fault is detected and the external terminal for RUN keeps ON, the drive can run after pressing RESET key.

02-50 Display the Status of Multi-function Input Terminal

Factory Setting: Read only

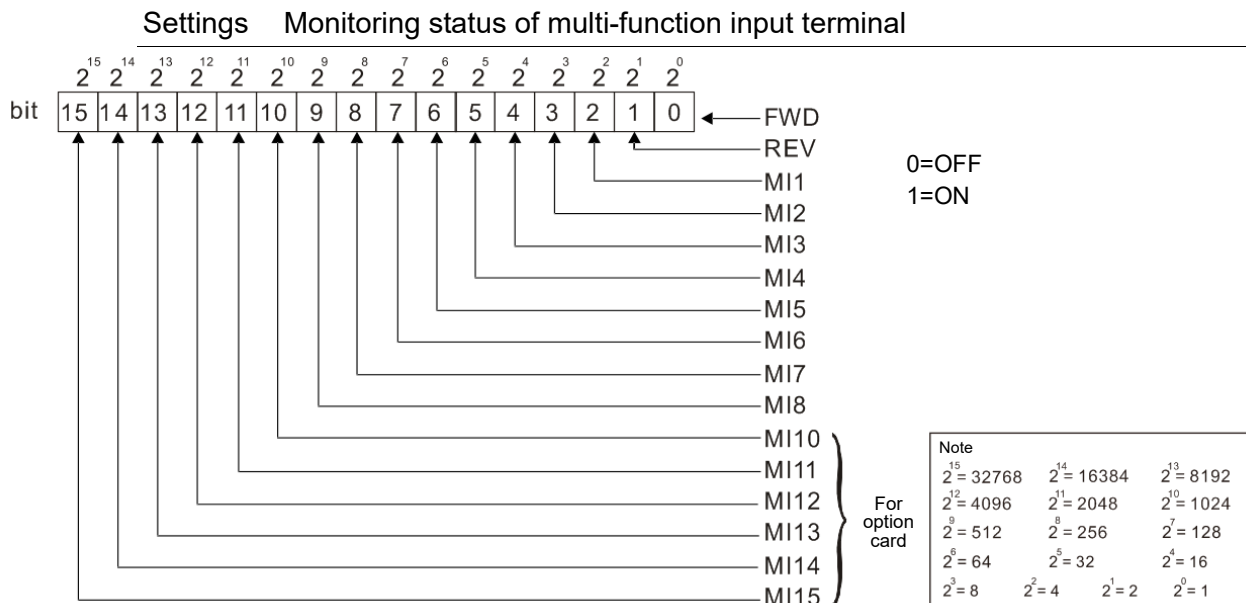

For Example:

If Pr.02-50 displays 0034h (Hex), i.e. the value is 52, and 110100 (binary). It means MI1, MI3 and MI4 are active.

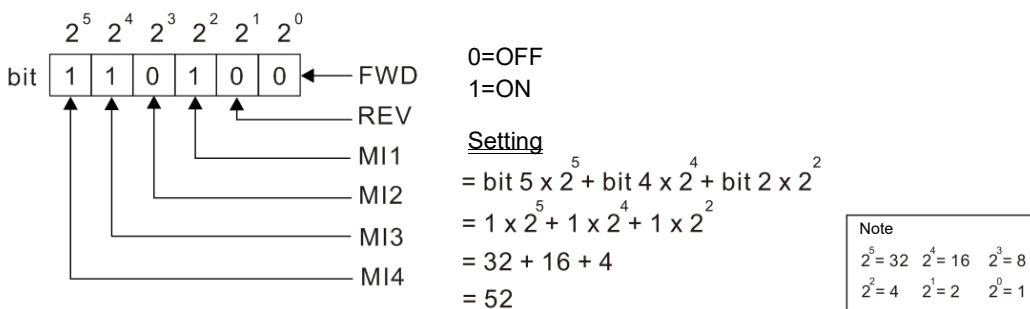

02-51 Status of Multi-function Output Terminal

Factory Setting: Read only

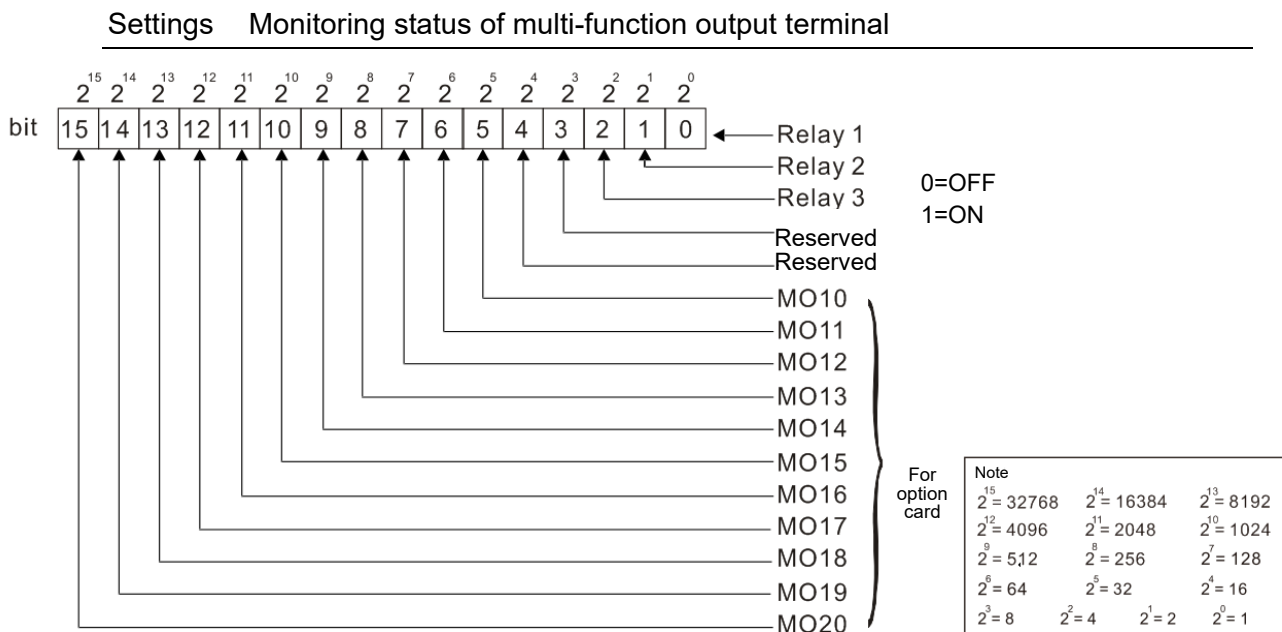

For Example:

If Pr.02-51 displays 000Bh (Hex), i.e. the value is 11, and 1011 (binary). It means RY1, RY2 and MO1 are ON.

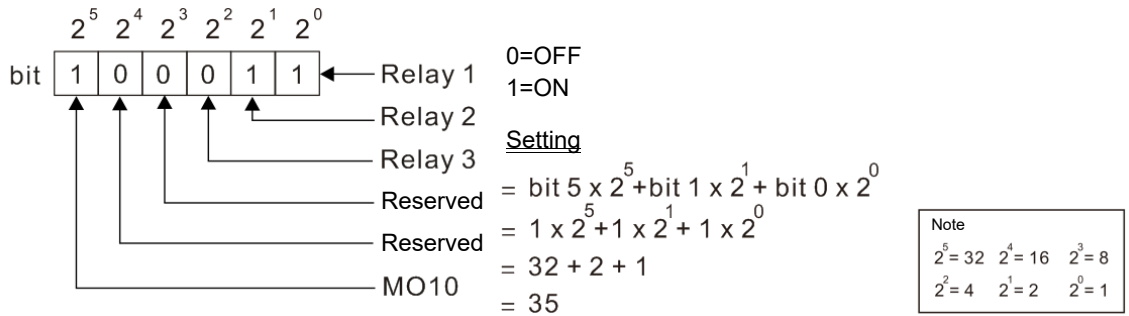

02-52 Display External Output terminal occupied by PLC

Factory Setting: Read only

Settings Monitoring status of PLC external output terminal

P.02-52 shows the external multi-function input terminal that used by PLC.

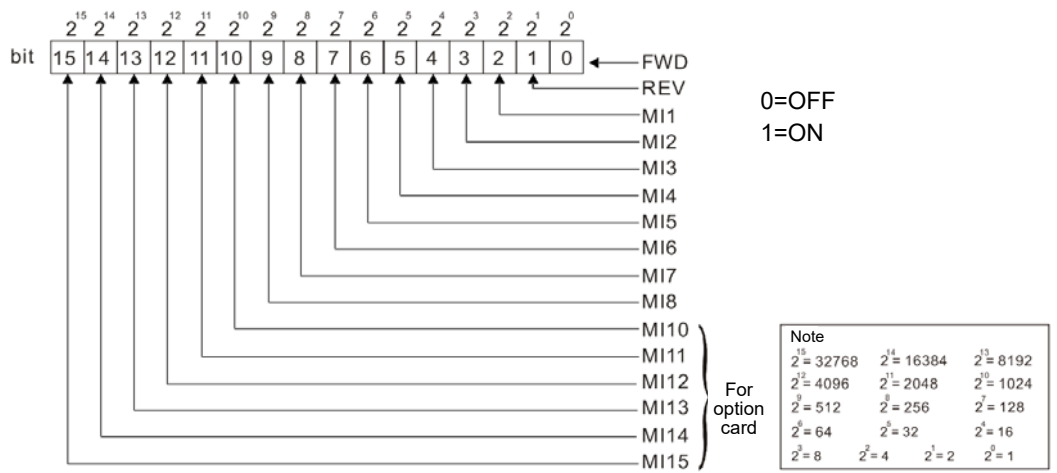

For Example:

When Pr.02-52 displays 0034h (hex) and switching to 110100 (binary), it means MI1, MI3 and MI4 are used by PLC.

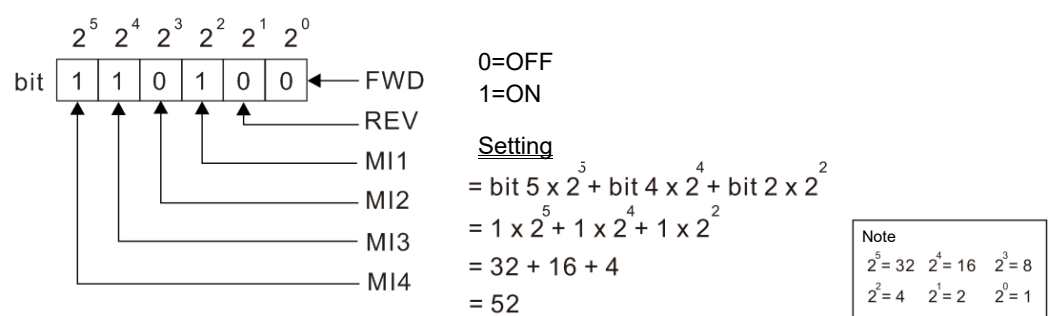

02-53 Display External Multi-function Output Terminal occupied by PLC

Factory Setting: Read only

Settings Monitoring status of PLC external multi-function output terminal

P.02-53 shows the external multi-function output terminal that used by PLC.

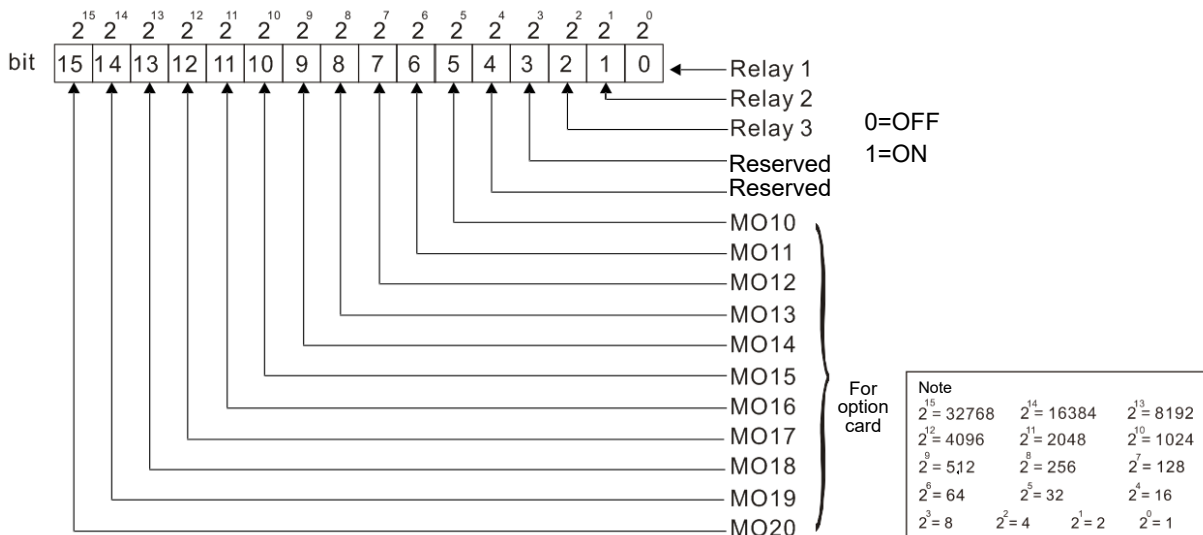

For Example:

If the value of Pr.02-53 displays 0003h (Hex), it means RY1 and RY2 are used by PLC.

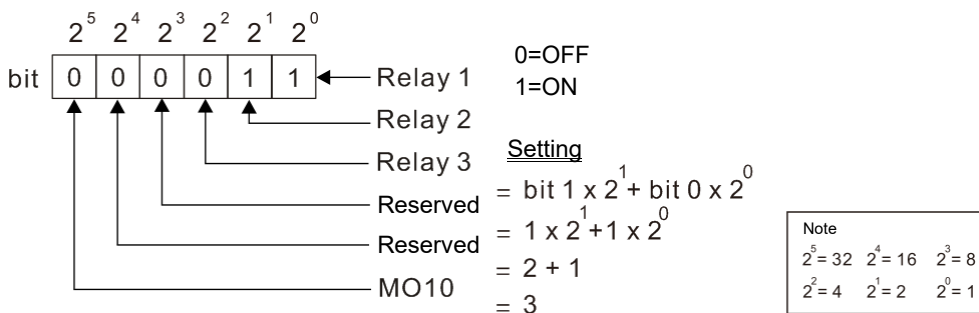

02-54 Display the Frequency Command Executed by External Terminal

Factory Setting: Read only

Settings 0.00~599.00Hz (Read only)

When the source of frequency command comes from the external terminal, if Lv or Fault occurs at this time, the frequency command of the external terminal will be saved in this parameter.

02-70 IO Card Type

Factory setting: Read only

- Settings 0: No IO Card
- 1: EMC-BPS01 Card
- 2: No IO Card
- 3: No IO Card
- 4: EMC-D611A Card
- 5: EMC-D42A Card
- 6: EMC-R6AA Card
- 7: No IO Card

02-72 Output Current Level of Preheating

Factory Setting: 0

Settings 0~100%

- When a motor drive is not in operation (STOP) and is placed in a cold and humid environment, enable the preheating function to output DC current to heat up the motor drive can prevent the invasion of the humidity to the motor drive which creates condensation affecting the normal function of the motor drive.
- This parameter sets the output current level from the motor drive to the motor after enabling the preheating. The percentage of the preheating DC current is 100% to the rated current of the motor drive (Pr.05-01, Pr.05-13 and Pr.05-34). When setting this parameter, increase slowly the percentage to reach the sufficient preheating temperature.

02-73 Output Current Cycle of Preheating

Factory Setting: 0

Settings 0~100%

- This parameter sets the output current cycle of preheating. 0 ~100% corresponds to 0~10 seconds. When set to 0%, there is no output current. When set to 100%, there is a continuous output. For example, when set to 50%, a cycle of preheating goes from OFF(5 seconds) to ON(5 seconds) and vice versa.

Related Parameters of Preheating

Parameter	Description	Setting Range	Explanation
02-72	Output Current Level of Preheating	0~100% (Rated Current of the Motor) 0% No output	
02-73	Output Cycle of Preheating	0~100% (0~10sec) 0% No output 100% Continuous output	
02-01~08 02-26~31	Multi-Input Function Commands (MFI)	69 Preheating Command	Enable or Disable the Preheating
02-13~15 02-36~46	Multi-Output Function Commands (MFO)	69 Output Command of Preheating	Indication of the Preheating

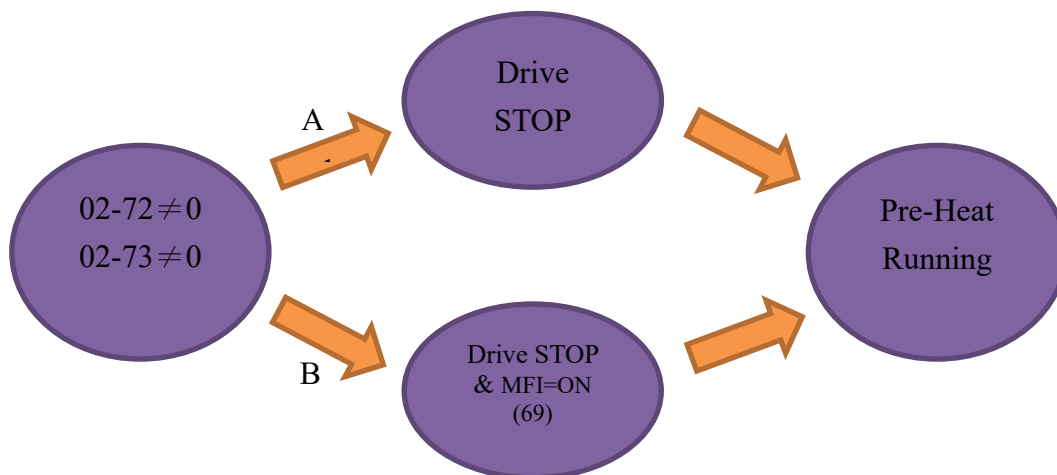

- Enable the Preheating: When Pr. 02-72 and Pr. 02-73 are NOT set to zero, the preheating is enabled.
- Preheating Function A: If Pr. 07-72 and Pr. 07-23 are set before the motor drive stops operation (STOP), the preheating will be enabled right after the motor drive stops. However if Pr. 07-72 and Pr. 07-73 are set after the motor drives stops operation, then preheating will not be enabled. Only after the motor drive stops again or restarts, the preheating will be enabled.
- Preheating Function B: When motor drive is in operation (RUN) or stops operating (STOP), set Pr. 02-72 and Pr. 02-73 between 1% ~100% and set MFI= 69 and MFI = On. The preheating will

be enabled when the motor drive stops, No matter if the motor drive is in operation (RUN) or stops operating (STOP).

- 📖 Operation priority: When both the preheating function A and B are given, the function B has the priority to operate.

Sequential Diagram of the Preheating Function:

📖 Setting Parameters to Enable Preheating (Function A)

Set Pr. 02-72 and Pr. 02-73 not equal to zero (Diagram 50%) and stop running the motor drive, then the preheating will be enabled to output DC current. In the meantime, MFO (Output Command of Preheating) will be ON (MFO =69). Once repower on, the preheating function will be enabled right away. Besides, the sequence of preheating goes from OFF (5 seconds) to ON (5 seconds). When the motor is in operation (RUN), the preheating function will be off even it is enabled. Meanwhile, MFO is OFF (MFO =69) and the preheating will be enabled when the motor drive stops.

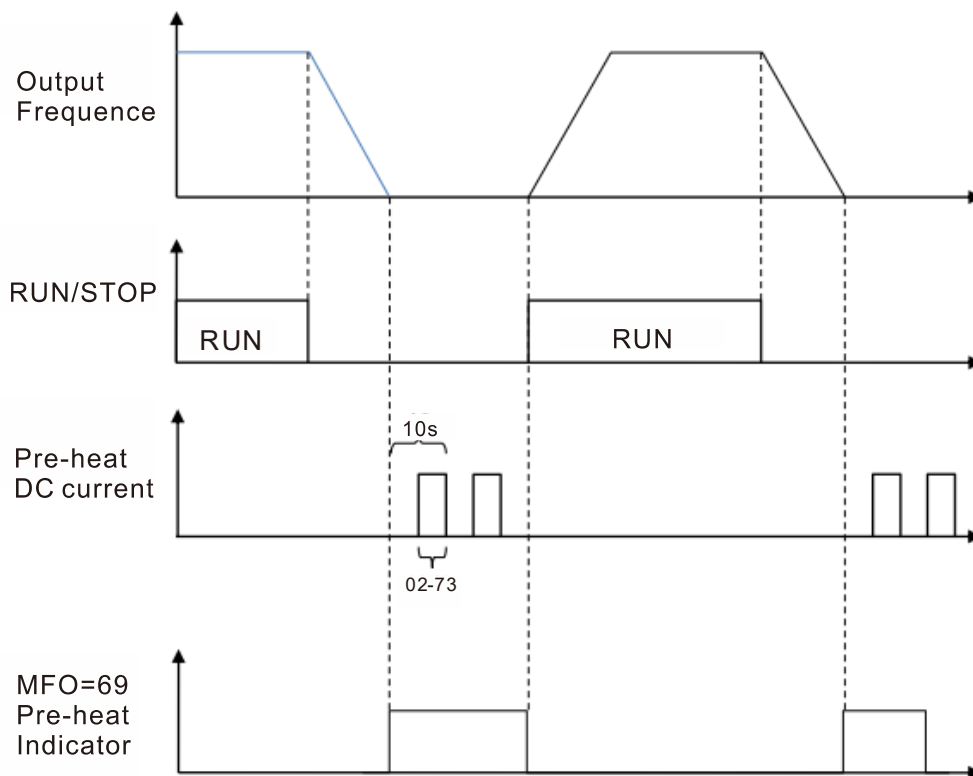

📖 Enable Preheating via Multi-Input Terminals (Function B)

Set Pr. 02-72 and Pr. 02-73 (Diagram 50%) not equal to zero and set MFI=69, MFI = ON, then this Function B has the priority to enable/ disable the preheating on the motor drive. In the meantime, the preheating by parameters is automatically ineffective. If, at this moment, the motor drive is already not in operation (STOP), the preheating will be enabled to output DC current and MFO (Output Command of Preheating) will be ON (MFO =69). Besides, the sequence of preheating goes from OFF (5 seconds) to ON (5 seconds). When the motor is in operation (RUN), the preheating function will be off even it is enabled. Meanwhile, MFO is OFF (MFO =69) and the preheating will be enabled when the motor drive stops.

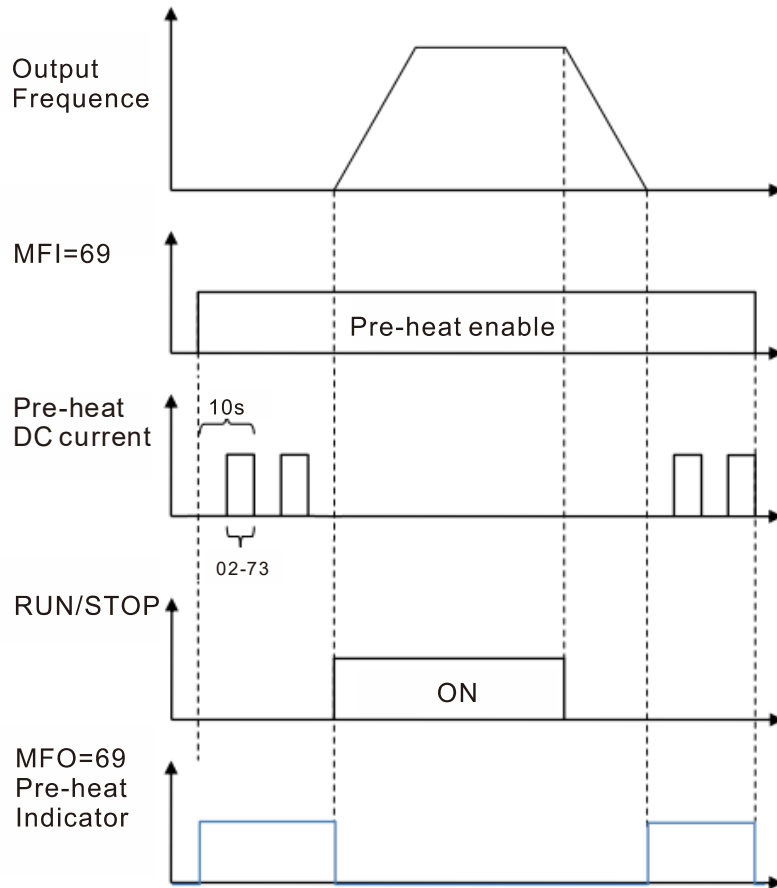

 Enable DC Brake Function

DC brake and preheating are enabled at the same time. The motor drive operates in the same logic as mentioned above. The only difference is that when the motor drive is in operation (RUN) or stops operating (STOP), DC brake will be enabled first. Then when motor drive stops, preheating will be activated.

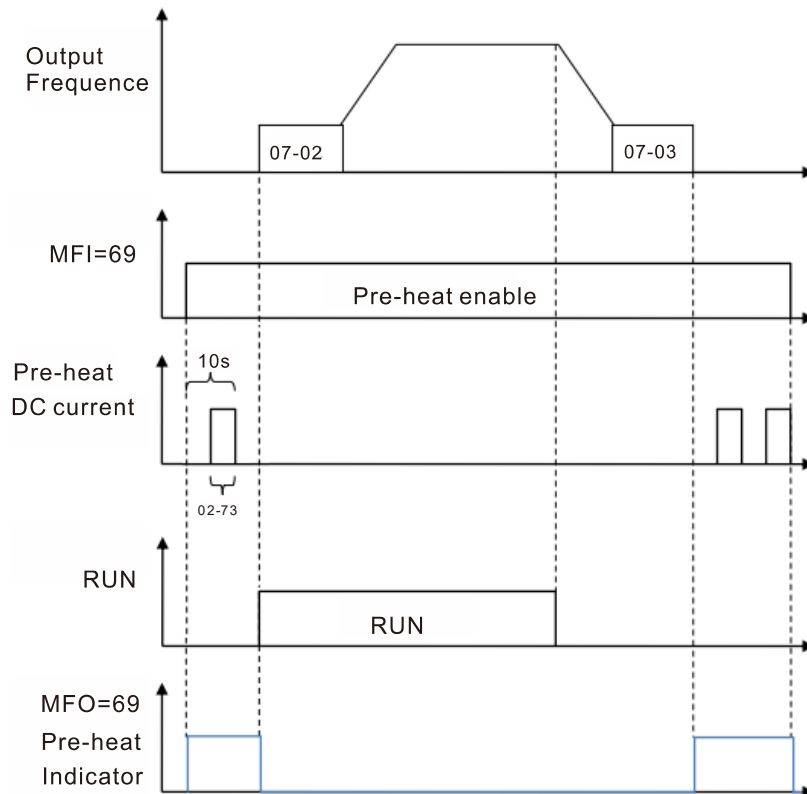

03 Analog Input/Output Parameter

✎ This parameter can be set during operation.

✎ **03-00** Analog Input Selection (AVI1)

Factory Setting: 1

✎ **03-01** Analog Input Selection (ACI)

Factory Setting: 0

✎ **03-02** Analog Input Selection (AVI2)

Factory Setting: 0

Settings

0: No function

1: Frequency command (speed limit under torque control mode)

4: PID target value

5: PID feedback signal

6: PTC thermistor input value

11: PT100 thermistor input value

13: PID bias value

📖 When use analog input as PID reference value, Pr00-20 must set 2 (analog input).

Setting method 1: Pr03-00~03-02 set 1 as PID reference input

Setting method 2: Pr03-00~03-02 set 4 as PID reference input

📖 When use analog input as PID compensation value, Pr08-16 must set 1 (Source of PID compensation is analog input). The compensation value can be observed via Pr08-17.

📖 When it is frequency command or TQC speed limit, the corresponding value for 0~±10V/4~20mA is 0 – max. output frequency(Pr.01-00)

📖 When Pr.03-00~Pr.03-02 have the same setting, then the AVI1 will be the prioritized selection.

✎ **03-03** Analog Input Bias (AVI1)

Factory Setting: 0

Settings -100.0~100.0%

📖 It is used to set the corresponding AVI1 voltage of the external analog input 0.

✎ **03-04** Analog Input Bias (ACI)

Factory Setting: 0

Settings -100.0~100.0%

📖 It is used to set the corresponding ACI voltage of the external analog input 0.

✎ **03-05** Analog Voltage Input Bias (AVI2)

Factory Setting: 0

Settings -100.0~100.0%

📖 It is used to set the corresponding AVI2 voltage of the external analog input 0.

📖 The relation between external input voltage/current and setting frequency: 0~10V (4~20mA) corresponds to 0~Pr01-00 (max. operation frequency).

↗ 03-07	Positive/negative Bias Mode (AVI1)
↗ 03-08	Positive/negative Bias Mode (ACI)
↗ 03-09	Positive/negative Bias Mode (AVI2)

Factory Setting: 0

- Settings
- 0: Zero bias
 - 1: Lower than or equal to bias
 - 2: Greater than or equal to bias
 - 3: The absolute value of the bias voltage while serving as the center
 - 4: Serve bias as the center

📖 In a noisy environment, it is advantageous to use negative bias to provide a noise margin. It is recommended NOT to use less than 1V to set the operation frequency.

↗ 03-10	Analog Frequency Command for Reverse Run
----------------	--

Factory Setting: 0

- Settings
- 0: Negative frequency is not valid. Forward and reverse run is controlled by digital keypad or external terminal.
 - 1: Negative frequency is valid. Positive frequency = forward run; negative frequency = reverse run. Run direction can not be switched by digital keypad or the external terminal control.

📖 Condition for negative frequency (reverse)

1. Pr03-10=1
2. Bias mode=Serve bias as center
3. Corresponded analog input gain < 0(negative), make input frequency be negative.

In using addition function of analog input (Pr03-18=1), when analog signal is negative after adding, this parameter can be set for allowing reverse or not. The result after adding will be restricted by "Condition for negative frequency (reverse)"

In the diagram below: Black line: Curve with no bias. Gray line: curve with bias

1.

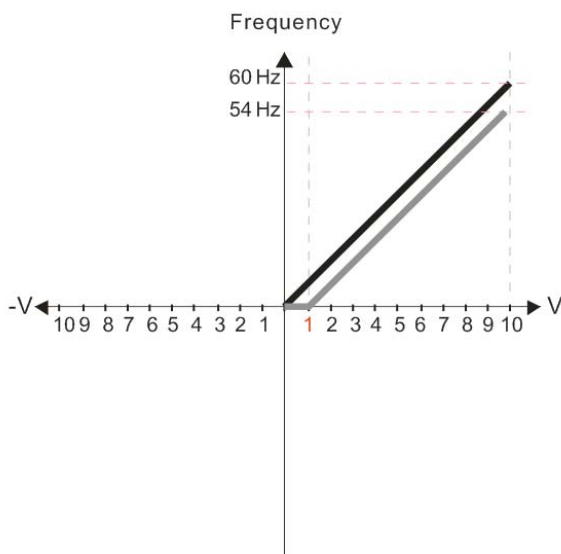

- Pr.03-03=10%
- Pr.03-07~03-09 (Positive/Negative Bias Mode)
 - 0: No bias
 - 1: Lower than or equal to bias**
 - 2: Greater than or equal to bias
 - 3: The absolute value of the bias voltage while serving as the center
 - 4: Serve bias as the center
- Pr.03-10 (Analog Frequency Command for Reverse Run)
 - 0: Negative frequency is not valid. Forward and reverse run is controlled by digital keypad or external terminal.**
 - 1: Negative frequency is valid. Positive frequency = forward run; negative frequency = reverse run. Direction cannot be switched by digital keypad or external terminal control.
- Pr.03-11 Analog Input Gain 1 (AVI1)= 100%

2.

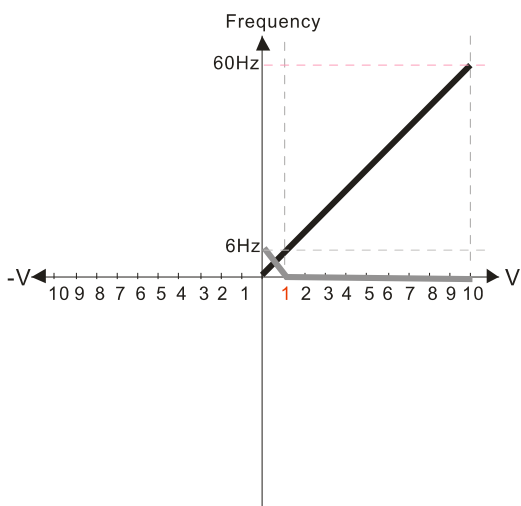

- Pr.03-03=10%
- Pr.03-07~03-09 (Positive/Negative Bias Mode)
 - 0: No bias
 - 1: Lower than or equal to bias
 - 2: Greater than or equal to bias
 - 3: The absolute value of the bias voltage while serving as the center
 - 4: Serve bias as the center
- Pr.03-10 (Analog Frequency Command for Reverse Run)
 - 0: Negative frequency is not valid. Forward and reverse run is controlled by digital keypad or external terminal.
 - 1: Negative frequency is valid. Positive frequency = forward run; negative frequency = reverse run. Direction can not be switched by digital keypad or external terminal control.
- Pr.03-11 Analog Input Gain (AVI)=100%

3.

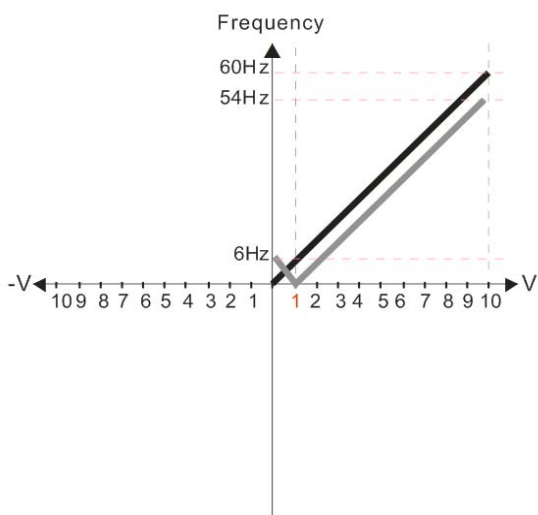

- Pr.03-03=10%
- Pr.03-07~03-09 (Positive/Negative Bias Mode)
 - 0: No bias
 - 1: Lower than or equal to bias
 - 2: Greater than or equal to bias
 - 3: The absolute value of the bias voltage while serving as the center
 - 4: Serve bias as the center
- Pr.03-10 (Analog Frequency Command for Reverse Run)
 - 0: Negative frequency is not valid. Forward and reverse run is controlled by digital keypad or external terminal.
 - 1: Negative frequency is valid. Positive frequency = forward run; negative frequency = reverse run. Direction can not be switched by digital keypad or external terminal control.
- Pr.03-11 Analog Input Gain 1(AVI1) = 100%

4.

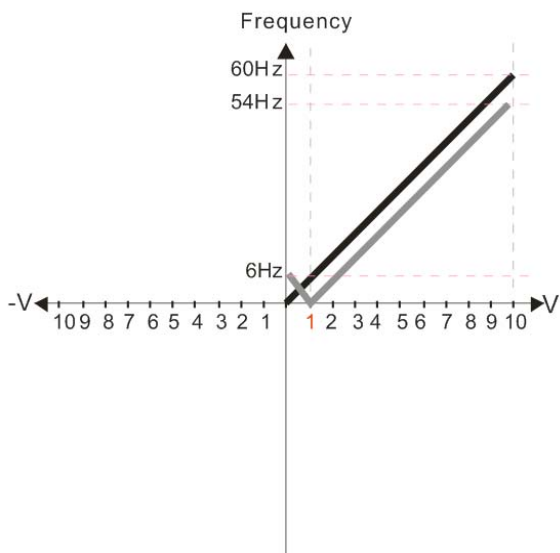

- Pr.03-03=10%
- Pr.03-07~03-09 (Positive/Negative Bias Mode)
 - 0: No bias
 - 1: Lower than or equal to bias
 - 2: Greater than or equal to bias
 - 3: The absolute value of the bias voltage while serving as the center
 - 4: Serve bias as the center
- Pr.03-10 (Analog Frequency Command for Reverse Run)
 - 0: Negative frequency is not valid. Forward and reverse run is controlled by digital keypad or external terminal.
 - 1: Negative frequency is valid. Positive frequency = forward run; negative frequency = reverse run. Direction can not be switched by digital keypad or external terminal control.
- Pr.03-11 Analog Input Gain1 (AVI 1) = 100%

5.

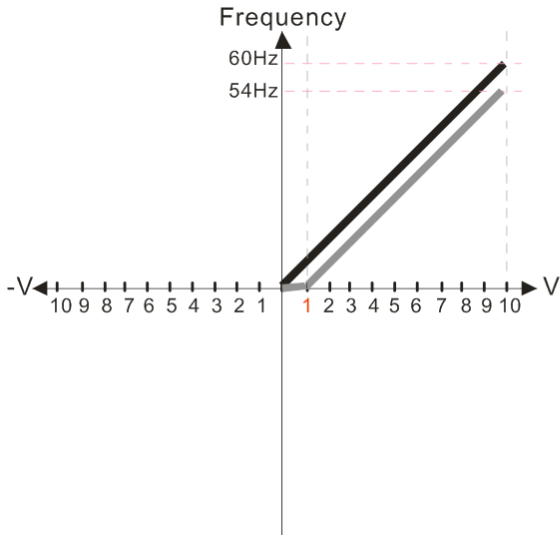

Pr.03-03=10%

Pr.03-07~03-09 (Positive/Negative Bias Mode)

- 0: No bias
- 1: Lower than or equal to bias
- 2: Greater than or equal to bias
- 3: The absolute value of the bias voltage while serving as the center
- 4: Serve bias as the center

Pr.03-10 (Analog Frequency Command for Reverse Run)

- 0: Negative frequency is not valid. Forward and reverse run is controlled by digital keypad or external terminal.
- 1: Negative frequency is valid. Positive frequency = forward run; negative frequency = reverse run. Direction can not be switched by digital keypad or external terminal control.

Pr.03-11 Analog Input Gain 1(AVI 1)= 100%

6.

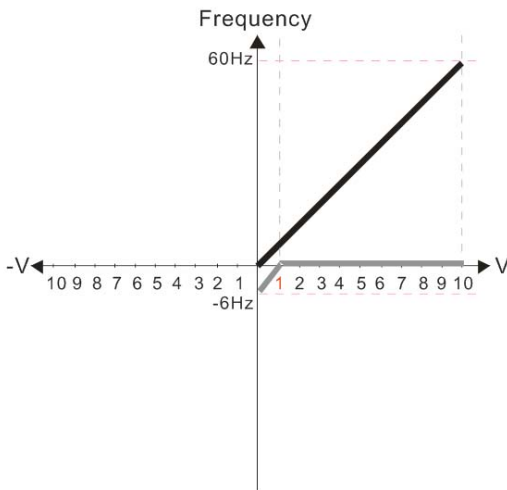

Pr.03-03=10%

Pr.03-07~03-09 (Positive/Negative Bias Mode)

- 0: No bias
- 1: Lower than or equal to bias
- 2: Greater than or equal to bias
- 3: The absolute value of the bias voltage while serving as the center
- 4: Serve bias as the center

Pr.03-10 (Analog Frequency Command for Reverse Run)

- 0: Negative frequency is not valid. Forward and reverse run is controlled by digital keypad or external terminal.
- 1: Negative frequency is valid. Positive frequency = forward run; negative frequency = reverse run. Direction can not be switched by digital keypad or external terminal control.

Pr.03-11 Analog Input Gain 1(AVI 1) = 100%

7.

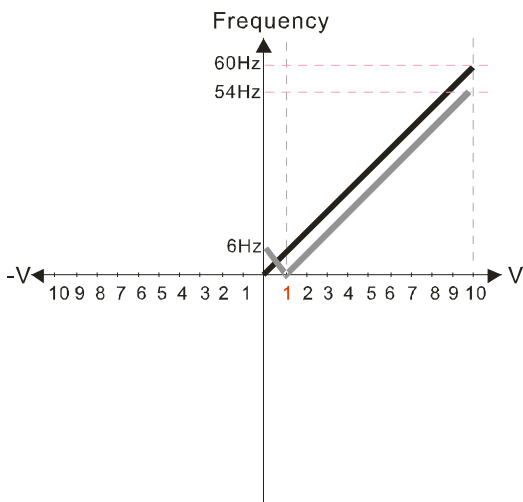

Pr.03-03=10%

Pr.03-07~03-09 (Positive/Negative Bias Mode)

- 0: No bias
- 1: Lower than or equal to bias
- 2: Greater than or equal to bias
- 3: The absolute value of the bias voltage while serving as the center
- 4: Serve bias as the center

Pr.03-10 (Analog Frequency Command for Reverse Run)

- 0: Negative frequency is not valid. Forward and reverse run is controlled by digital keypad or external terminal.
- 1: Negative frequency is valid. Positive frequency = forward run; negative frequency = reverse run. Direction can not be switched by digital keypad or external terminal control.

Pr.03-11 Analog Input Gain 1 (AVI 1) = 100%

8.

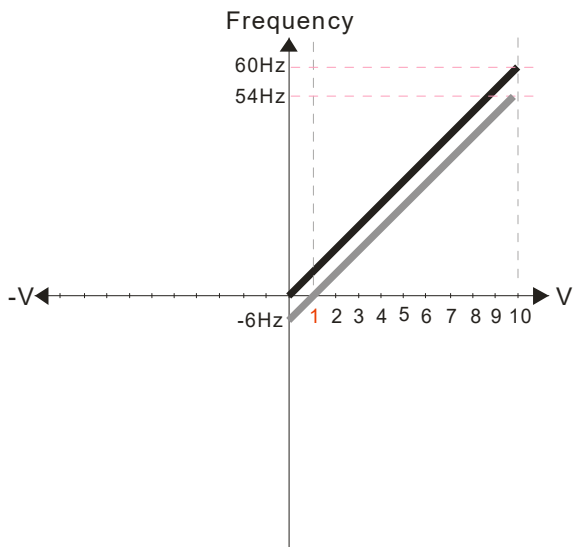

Pr.03-03=10%

Pr.03-07~03-09 (Positive/Negative Bias Mode)

- 0: No bias
- 1: Lower than or equal to bias
- 2: Greater than or equal to bias
- 3: The absolute value of the bias voltage while serving as the center
- 4: Serve bias as the center

Pr.03-10 (Analog Frequency Command for Reverse Run)

- 0: Negative frequency is not valid. Forward and reverse run is controlled by digital keypad or external terminal.
- 1: Negative frequency is valid. Positive frequency = forward run; negative frequency = reverse run. Direction can not be switched by digital keypad or external terminal control.

Pr.03-11 Analog Input Gain 1(AVI 1) = 100%

9.

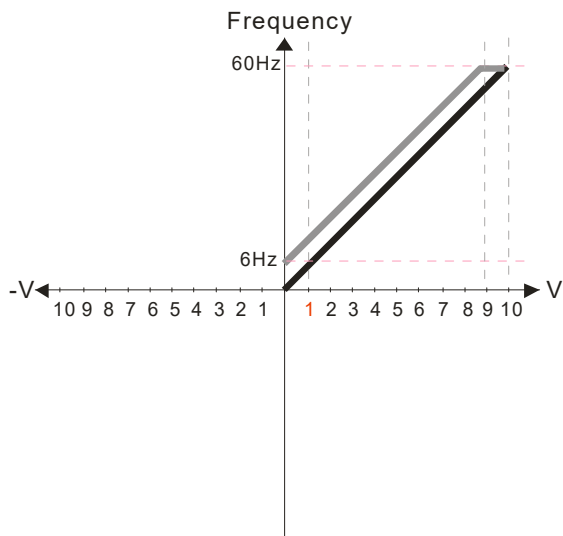

Pr.03-03=-10%

Pr.03-07~03-09 (Positive/Negative Bias Mode)

- 0: No bias
- 1: Lower than or equal to bias
- 2: Greater than or equal to bias
- 3: The absolute value of the bias voltage while serving as the center
- 4: Serve bias as the center

Pr.03-10 (Analog Frequency Command for Reverse Run)

- 0: Negative frequency is not valid. Forward and reverse run is controlled by digital keypad or external terminal.
- 1: Negative frequency is valid. Positive frequency = forward run; negative frequency = reverse run. Direction can not be switched by digital keypad or external terminal control.

Pr.03-11 Analog Input Gain 1 (AVI 1)= 100%

10.

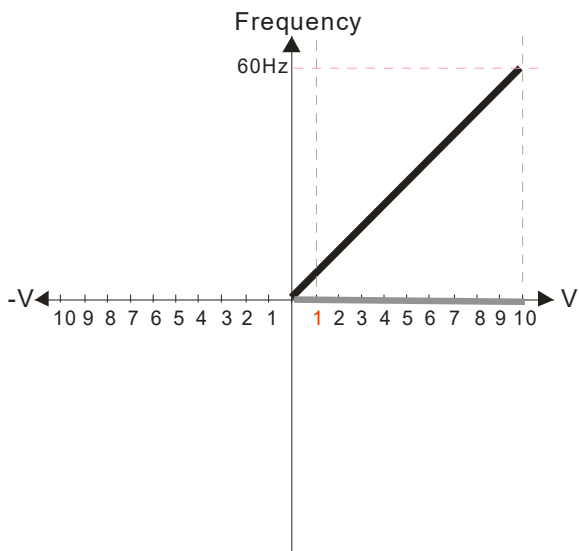

Pr.03-03=-10%

Pr.03-07~03-09 (Positive/Negative Bias Mode)

- 0: No bias
- 1: Lower than or equal to bias
- 2: Greater than or equal to bias
- 3: The absolute value of the bias voltage while serving as the center
- 4: Serve bias as the center

Pr.03-10 (Analog Frequency Command for Reverse Run)

- 0: Negative frequency is not valid. Forward and reverse run is controlled by digital keypad or external terminal.
- 1: Negative frequency is valid. Positive frequency = forward run; negative frequency = reverse run. Direction can not be switched by digital keypad or external terminal control.

Pr.03-11 Analog Input Gain 1 (AVI 1) = 100%

11.

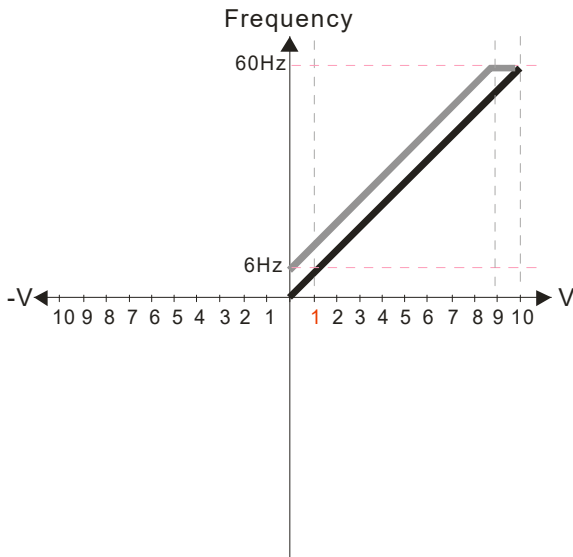

- Pr.03-03=-10%
- Pr.03-07~03-09 (Positive/Negative Bias Mode)
 - 0: No bias
 - 1: Lower than or equal to bias
 - 2: Greater than or equal to bias
 - 3: The absolute value of the bias voltage while serving as the center
 - 4: Serve bias as the center

- Pr.03-10 (Analog Frequency Command for Reverse Run)
 - 0: Negative frequency is not valid. Forward and reverse run is controlled by digital keypad or external terminal.
 - 1: Negative frequency is valid. Positive frequency = forward run; negative frequency = reverse run. Direction can not be switched by digital keypad or external terminal control.

Pr.03-11 Analog Input Gain 1 (AVI 1) = 100%

12.

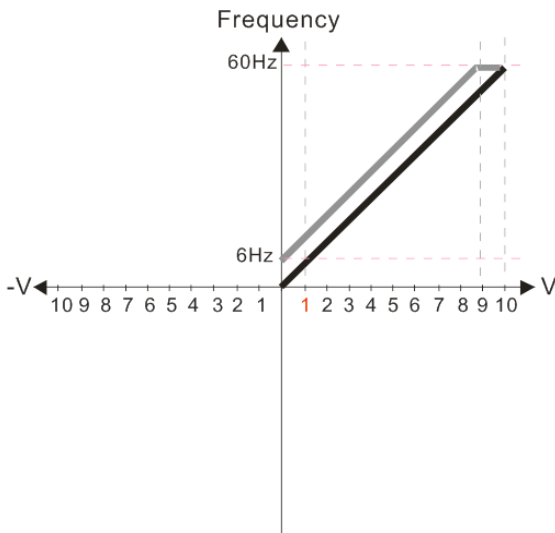

- Pr.03-03=-10%
- Pr.03-07~03-09 (Positive/Negative Bias Mode)
 - 0: No bias
 - 1: Lower than or equal to bias
 - 2: Greater than or equal to bias
 - 3: The absolute value of the bias voltage while serving as the center
 - 4: Serve bias as the center

- Pr.03-10 (Analog Frequency Command for Reverse Run)
 - 0: Negative frequency is not valid. Forward and reverse run is controlled by digital keypad or external terminal.
 - 1: Negative frequency is valid. Positive frequency = forward run; negative frequency = reverse run. Direction can not be switched by digital keypad or external terminal control.

Pr.03-11 Analog Input Gain 1 (AVI 1) = 100%

13.

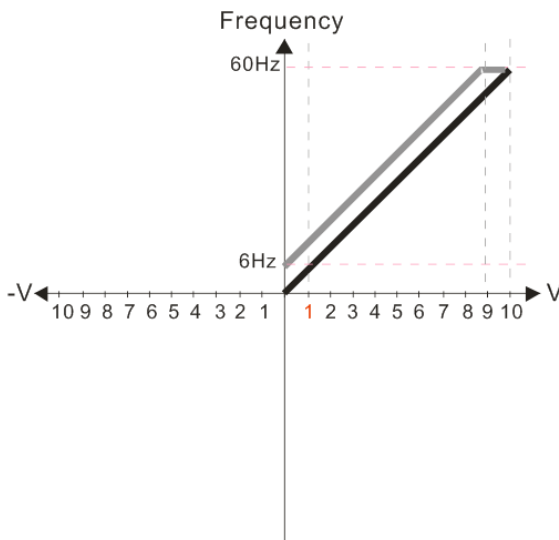

- Pr.03-03=-10%
- Pr.03-07~03-09 (Positive/Negative Bias Mode)
 - 0: No bias
 - 1: Lower than or equal to bias
 - 2: Greater than or equal to bias
 - 3: The absolute value of the bias voltage while serving as the center
 - 4: Serve bias as the center

- Pr.03-10 (Analog Frequency Command for Reverse Run)
 - 0: Negative frequency is not valid. Forward and reverse run is controlled by digital keypad or external terminal.
 - 1: Negative frequency is valid. Positive frequency = forward run; negative frequency = reverse run. Direction can not be switched by digital keypad or external terminal control.

Pr.03-11 Analog Input Gain 1 (AVI 1) = 100%

14.

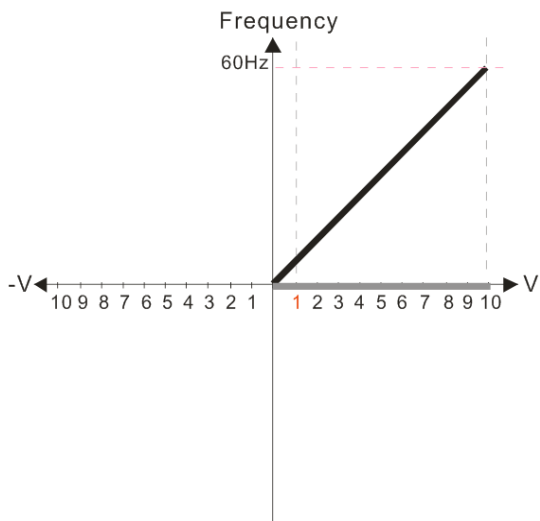

Pr.03-03=-10%

Pr.03-07~03-09 (Positive/Negative Bias Mode)

- 0: No bias
- 1: Lower than or equal to bias
- 2: Greater than or equal to bias
- 3: The absolute value of the bias voltage while serving as the center
- 4: Serve bias as the center

Pr.03-10 (Analog Frequency Command for Reverse Run)

- 0: Negative frequency is not valid. Forward and reverse run is controlled by digital keypad or external terminal.
- 1: Negative frequency is valid. Positive frequency = forward run; negative frequency = reverse run. Direction can not be switched by digital keypad or external terminal control.

Pr.03-11 Analog Input Gain 1 (AVI1)= 100%

15.

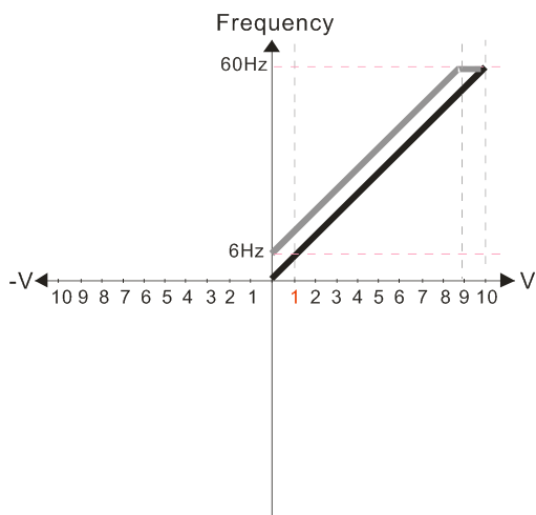

Pr.03-03=-10%

Pr.03-07~03-09 (Positive/Negative Bias Mode)

- 0: No bias
- 1: Lower than or equal to bias
- 2: Greater than or equal to bias
- 3: The absolute value of the bias voltage while serving as the center
- 4: Serve bias as the center

Pr.03-10 (Analog Frequency Command for Reverse Run)

- 0: Negative frequency is not valid. Forward and reverse run is controlled by digital keypad or external terminal.
- 1: Negative frequency is valid. Positive frequency = forward run; negative frequency = reverse run. Direction can not be switched by digital keypad or external terminal control.

Pr.03-11 Analog Input Gain 1(AVI 1) = 100%

16.

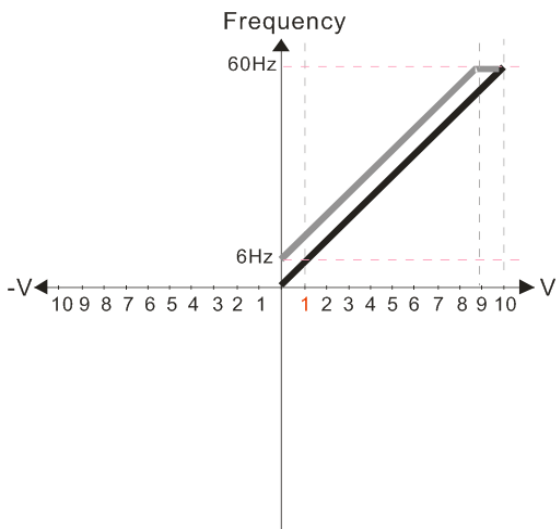

Pr.03-03=-10%

Pr.03-07~03-09 (Positive/Negative Bias Mode)

- 0: No bias
- 1: Lower than or equal to bias
- 2: Greater than or equal to bias
- 3: The absolute value of the bias voltage while serving as the center
- 4: Serve bias as the center

Pr.03-10 (Analog Frequency Command for Reverse Run)

- 0: Negative frequency is not valid. Forward and reverse run is controlled by digital keypad or external terminal.
- 1: Negative frequency is valid. Positive frequency = forward run; negative frequency = reverse run. Direction can not be switched by digital keypad or external terminal control.

Pr.03-11 Analog Input Gain 1(AVI 1) = 100%

17.

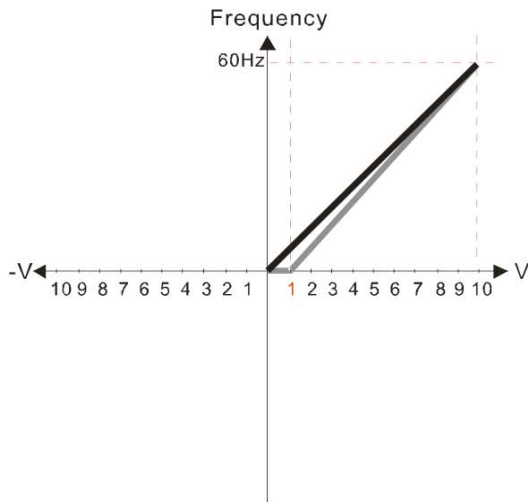

Pr.03-03=-10%

Pr.03-07~03-09 (Positive/Negative Bias Mode)

- 0: No bias
- 1: Lower than or equal to bias
- 2: Greater than or equal to bias
- 3: The absolute value of the bias voltage while serving as the center
- 4: Serve bias as the center

Pr.03-10 (Analog Frequency Command for Reverse Run)

- 0: Negative frequency is not valid. Forward and reverse run is controlled by digital keypad or external terminal.
- 1: Negative frequency is valid. Positive frequency = forward run; negative frequency = reverse run. Direction can not be switched by digital keypad or external terminal control.

Pr.03-11 Analog Input Gain 1 (AVI 1)= 111.1%

$$10/9=111.1\%$$

18.

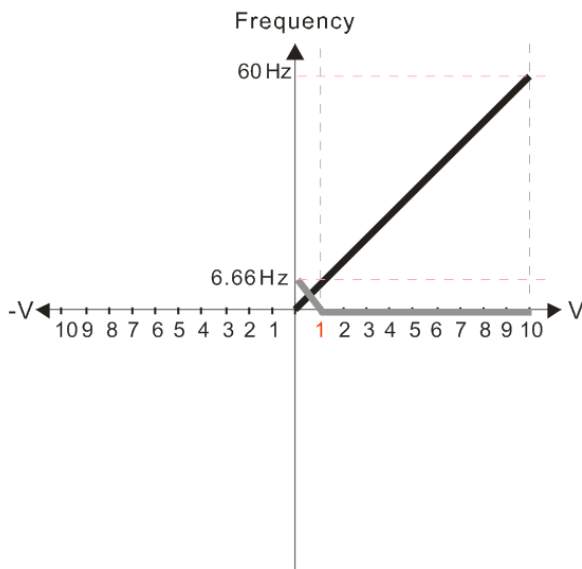

Pr.03-03=10%

Pr.03-07~03-09 (Positive/Negative Bias Mode)

- 0: No bias
- 1: Lower than or equal to bias
- 2: Greater than or equal to bias
- 3: The absolute value of the bias voltage while serving as the center
- 4: Serve bias as the center

Pr.03-10 (Analog Frequency Command for Reverse Run)

- 0: Negative frequency is not valid. Forward and reverse run is controlled by digital keypad or external terminal.
- 1: Negative frequency is valid. Positive frequency = forward run; negative frequency = reverse run. Direction can not be switched by digital keypad or external terminal control.

Pr.03-11 Analog Input Gain 1 (AVI 1)=111.1%

$$10/9 = 111.1\%$$

19.

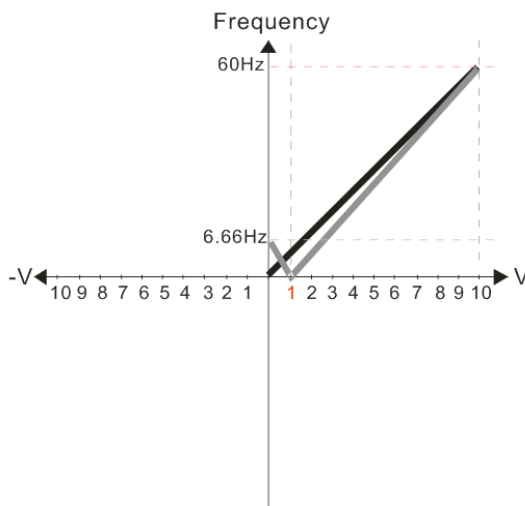

Pr.03-03=10%

Pr.03-07~03-09 (Positive/Negative Bias Mode)

- 0: No bias
- 1: Lower than or equal to bias
- 2: Greater than or equal to bias
- 3: The absolute value of the bias voltage while serving as the center
- 4: Serve bias as the center

Pr.03-10 (Analog Frequency Command for Reverse Run)

- 0: Negative frequency is not valid. Forward and reverse run is controlled by digital keypad or external terminal.
- 1: Negative frequency is valid. Positive frequency = forward run; negative frequency = reverse run. Direction can not be switched by digital keypad or external terminal control.

Pr.03-11 Analog Input Gain 1 (AVI 1) = 111.1%

$$10/9 = 111.1\%$$

20.

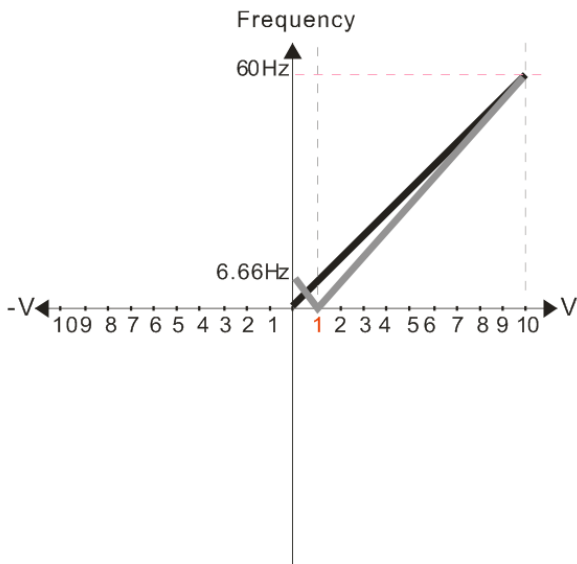

Pr.03-03=10%

Pr.03-07~03-09 (Positive/Negative Bias Mode)

- 0: No bias
- 1: Lower than or equal to bias
- 2: Greater than or equal to bias
- 3: The absolute value of the bias voltage while serving as the center
- 4: Serve bias as the center

Pr.03-10 (Analog Frequency Command for Reverse Run)

- 0: Negative frequency is not valid. Forward and reverse run is controlled by digital keypad or external terminal.
- 1: Negative frequency is valid. Positive frequency = forward run; negative frequency = reverse run. Direction can not be switched by digital keypad or external terminal control.

Pr.03-11 Analog Input Gain 1 (AVI 1) = 111.1%
 $10/9 = 111.1\%$

21.

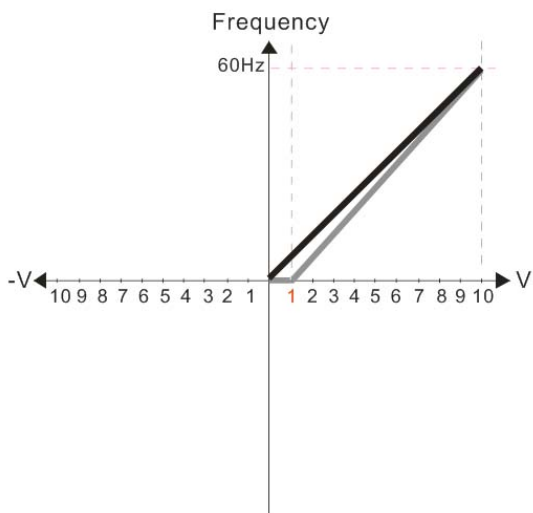

Pr.03-03=10%

Pr.03-07~03-09 (Positive/Negative Bias Mode)

- 0: No bias
- 1: Lower than or equal to bias
- 2: Greater than or equal to bias
- 3: The absolute value of the bias voltage while serving as the center
- 4: Serve bias as the center

Pr.03-10 (Analog Frequency Command for Reverse Run)

- 0: Negative frequency is not valid. Forward and reverse run is controlled by digital keypad or external terminal.
- 1: Negative frequency is valid. Positive frequency = forward run; negative frequency = reverse run. Direction can not be switched by digital keypad or external terminal control.

Pr.03-11 Analog Input Gain 1 (AVI 1) = 111.1%
 $10/9 = 111.1\%$

22.

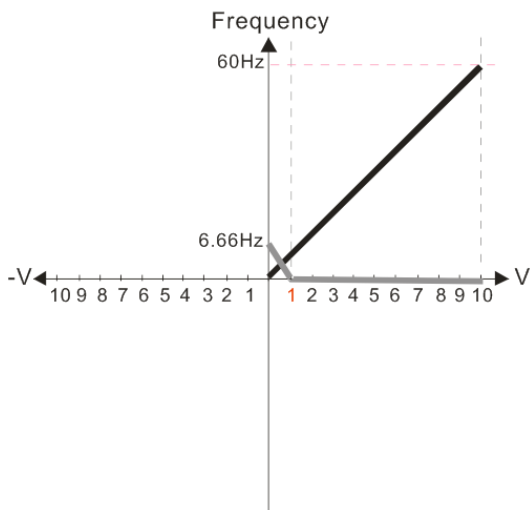

Pr.03-03=10%

Pr.03-07~03-09 (Positive/Negative Bias Mode)

- 0: No bias
- 1: Lower than or equal to bias
- 2: Greater than or equal to bias
- 3: The absolute value of the bias voltage while serving as the center
- 4: Serve bias as the center

Pr.03-10 (Analog Frequency Command for Reverse Run)

- 0: Negative frequency is not valid. Forward and reverse run is controlled by digital keypad or external terminal.
- 1: Negative frequency is valid. Positive frequency = forward run; negative frequency = reverse run. Direction can not be switched by digital keypad or external terminal control.

Pr.03-11 Analog Input Gain 1 (AVI 1) = 111.1%
 $10/9 = 111.1\%$

23.

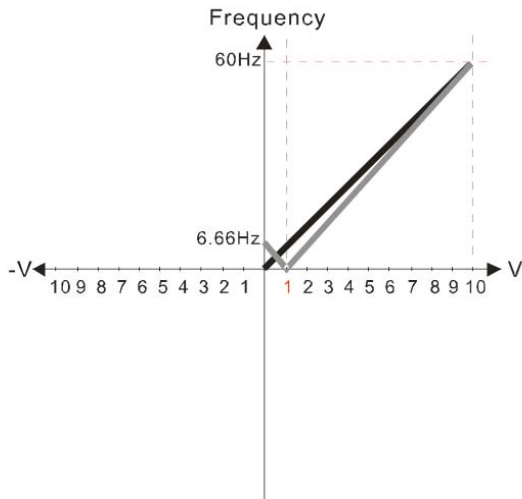

Pr.03-03=10%

Pr.03-07~03-09 (Positive/Negative Bias Mode)

- 0: No bias
- 1: Lower than or equal to bias
- 2: Greater than or equal to bias
- 3: The absolute value of the bias voltage while serving as the center
- 4: Serve bias as the center

Pr.03-10 (Analog Frequency Command for Reverse Run)

- 0: Negative frequency is not valid. Forward and reverse run is controlled by digital keypad or external terminal.
- 1: Negative frequency is valid. Positive frequency = forward run; negative frequency = reverse run. Direction can not be switched by digital keypad or external terminal control.

Pr03-11 Analog Input Gain 1 (AVI 1) = 111.1%
 $10/9 = 111.1\%$

24.

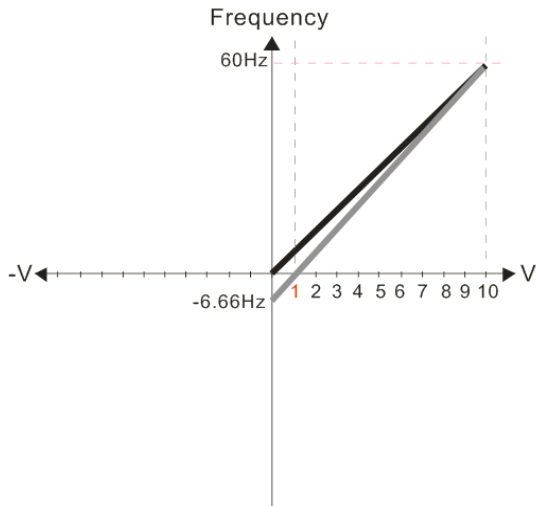

Pr.03-03=10%

Pr.03-07~03-09 (Positive/Negative Bias Mode)

- 0: No bias
- 1: Lower than or equal to bias
- 2: Greater than or equal to bias
- 3: The absolute value of the bias voltage while serving as the center
- 4: Serve bias as the center

Pr.03-10 (Analog Frequency Command for Reverse Run)

- 0: Negative frequency is not valid. Forward and reverse run is controlled by digital keypad or external terminal.
- 1: Negative frequency is valid. Positive frequency = forward run; negative frequency = reverse run. Direction can not be switched by digital keypad or external terminal control.

Pr03-11 Analog Input Gain 1 (AVI 1) = 111.1%
 $10/9 = 111.1\%$

25.

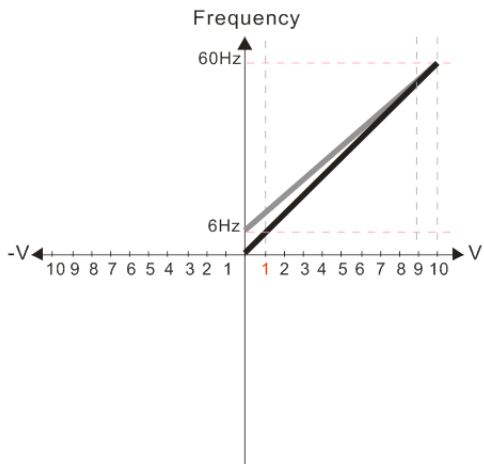

Pr.03-07~03-09 (Positive/Negative Bias Mode)

- 0: No bias
- 1: Lower than or equal to bias
- 2: Greater than or equal to bias
- 3: The absolute value of the bias voltage while serving as the center
- 4: Serve bias as the center

Pr.03-10 (Analog Frequency Command for Reverse Run)

- 0: Negative frequency is not valid. Forward and reverse run is controlled by digital keypad or external terminal.
- 1: Negative frequency is valid. Positive frequency = forward run; negative frequency = reverse run. Direction can not be switched by digital keypad or external terminal control.

Calculate the bias: $\frac{60-6\text{Hz}}{10\text{V}} = \frac{6-0\text{Hz}}{(0-X\text{V})}$ $X\text{V} = \frac{10}{-9} = -1.11\text{V}$

$\therefore \text{Pr.03-03} = \frac{-1.11}{10} \times 100\% = -11.1\%$

Calculate the gain: $\text{Pr.03-11} = \frac{10\text{V}}{11.1\text{V}} \times 100\% = 90.0\%$

26.

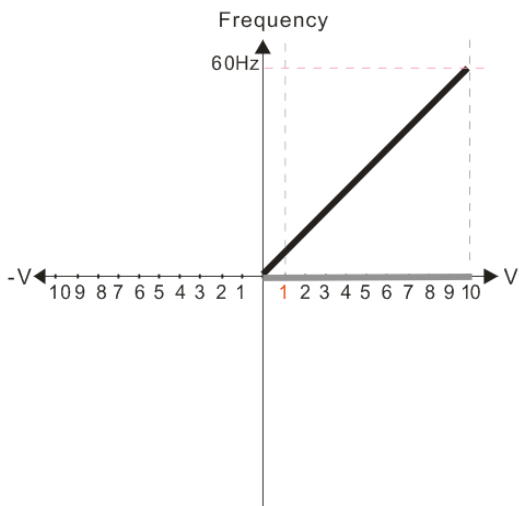

Pr.03-07~03-09 (Positive/Negative Bias Mode)

- 0: No bias
- 1: Lower than or equal to bias
- 2: Greater than or equal to bias
- 3: The absolute value of the bias voltage while serving as the center
- 4: Serve bias as the center

Pr.03-10 (Analog Frequency Command for Reverse Run)

- 0: Negative frequency is not valid. Forward and reverse run is controlled by digital keypad or external terminal.
- 1: Negative frequency is valid. Positive frequency = forward run; negative frequency = reverse run. Direction can not be switched by digital keypad or external terminal control.

27.

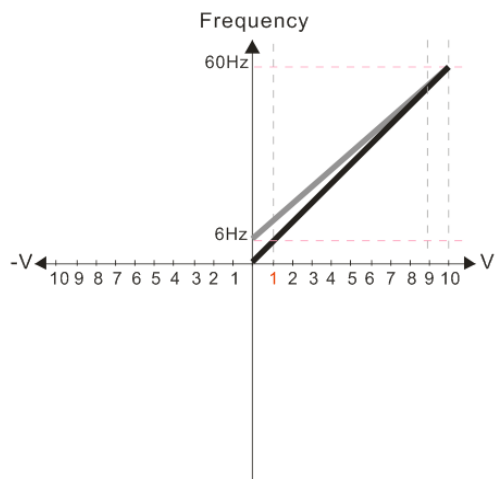

Pr.03-07~03-09 (Positive/Negative Bias Mode)

- 0: No bias
- 1: Lower than or equal to bias
- 2: Greater than or equal to bias
- 3: The absolute value of the bias voltage while serving as the center
- 4: Serve bias as the center

Pr.03-10 (Analog Frequency Command for Reverse Run)

- 0: Negative frequency is not valid. Forward and reverse run is controlled by digital keypad or external terminal.
- 1: Negative frequency is valid. Positive frequency = forward run; negative frequency = reverse run. Direction can not be switched by digital keypad or external terminal control.

Calculate the bias: $\frac{60-6\text{Hz}}{10\text{V}} = \frac{6-0\text{Hz}}{(0-X\text{V})}$ $X\text{V} = \frac{10}{-9} = -1.11\text{V}$

$\Delta \text{Pr.03-03} = \frac{-1.11}{10} \times 100\% = -11.1\%$

Calculate the gain: $\text{Pr.03-11} = \frac{10\text{V}}{11.1\text{V}} \times 100\% = 90.0\%$

28.

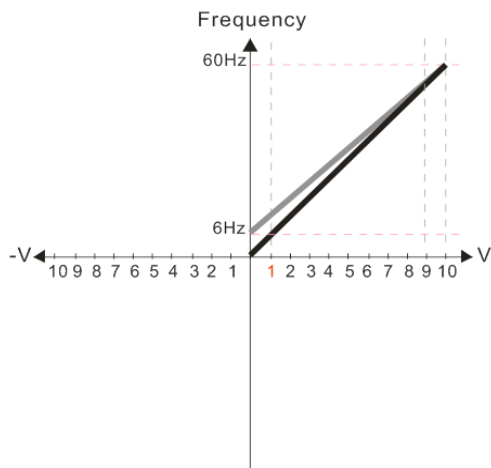

Pr.03-07~03-09 (Positive/Negative Bias Mode)

- 0: No bias
- 1: Lower than or equal to bias
- 2: Greater than or equal to bias
- 3: The absolute value of the bias voltage while serving as the center
- 4: Serve bias as the center

Pr.03-10 (Analog Frequency Command for Reverse Run)

- 0: Negative frequency is not valid. Forward and reverse run is controlled by digital keypad or external terminal.
- 1: Negative frequency is valid. Positive frequency = forward run; negative frequency = reverse run. Direction can not be switched by digital keypad or external terminal control.

Calculate the bias: $\frac{60-6\text{Hz}}{10\text{V}} = \frac{6-0\text{Hz}}{(0-X\text{V})}$ $X\text{V} = \frac{10}{-9} = -1.11\text{V}$

$\Delta \text{Pr.03-03} = \frac{-1.11}{10} \times 100\% = -11.1\%$

Calculate the gain: $\text{Pr.03-11} = \frac{10\text{V}}{11.1\text{V}} \times 100\% = 90.0\%$

29.

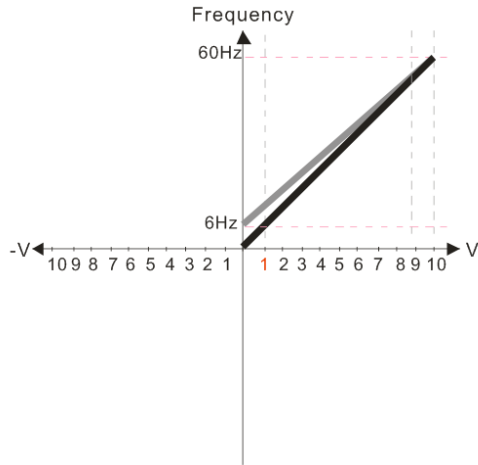

Pr.03-07~03-09 (Positive/Negative Bias Mode)

- 0: No bias
- 1: Lower than or equal to bias
- 2: Greater than or equal to bias
- 3: The absolute value of the bias voltage while serving as the center
- 4: Serve bias as the center

Pr.03-10 (Analog Frequency Command for Reverse Run)

- 0: Negative frequency is not valid. Forward and reverse run is controlled by digital keypad or external terminal.
- 1: Negative frequency is valid. Positive frequency = forward run; negative frequency = reverse run. Direction can not be switched by digital keypad or external terminal control.

Calculate the bias: $\frac{60-6\text{Hz}}{10\text{V}} = \frac{6-0\text{Hz}}{(0-X\text{V})}$ $X\text{V} = \frac{10}{-9} = -1.11\text{V}$
 $\therefore \text{Pr.03-03} = \frac{-1.11}{10} \times 100\% = -11.1\%$

Calculate the gain: $\text{Pr.03-11} = \frac{10\text{V}}{11.1\text{V}} \times 100\% = 90.0\%$

30.

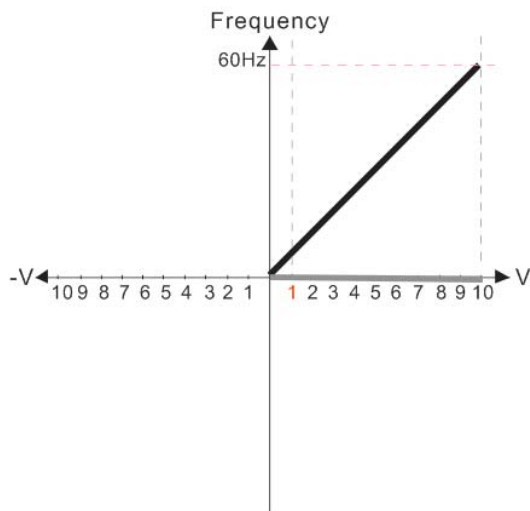

Pr.03-07~03-09 (Positive/Negative Bias Mode)

- 0: No bias
- 1: Lower than or equal to bias
- 2: Greater than or equal to bias
- 3: The absolute value of the bias voltage while serving as the center
- 4: Serve bias as the center

Pr.03-10 (Analog Frequency Command for Reverse Run)

- 0: Negative frequency is not valid. Forward and reverse run is controlled by digital keypad or external terminal.
- 1: Negative frequency is valid. Positive frequency = forward run; negative frequency = reverse run. Direction can not be switched by digital keypad or external terminal control.

31.

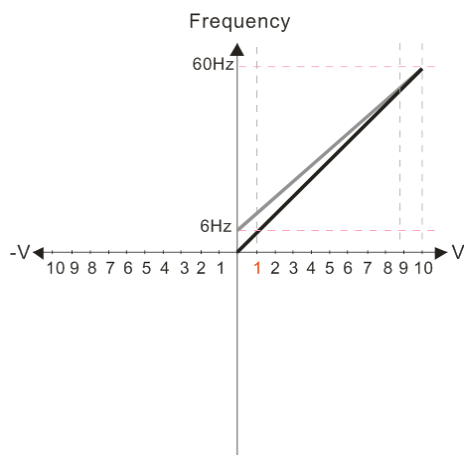

Pr.03-07~03-09 (Positive/Negative Bias Mode)

- 0: No bias
- 1: Lower than or equal to bias
- 2: Greater than or equal to bias
- 3: The absolute value of the bias voltage while serving as the center
- 4: Serve bias as the center

Pr.03-10 (Analog Frequency Command for Reverse Run)

- 0: Negative frequency is not valid. Forward and reverse run is controlled by digital keypad or external terminal.
- 1: Negative frequency is valid. Positive frequency = forward run; negative frequency = reverse run. Direction can not be switched by digital keypad or external terminal control.

Calculate the bias: $\frac{60-6\text{Hz}}{10\text{V}} = \frac{6-0\text{Hz}}{(0-X\text{V})}$ $X\text{V} = \frac{10}{-9} = -1.11\text{V}$
 $\therefore \text{Pr.03-03} = \frac{-1.11}{10} \times 100\% = -11.1\%$

Calculate the gain: $\text{Pr.03-11} = \frac{10\text{V}}{11.1\text{V}} \times 100\% = 90.0\%$

32.

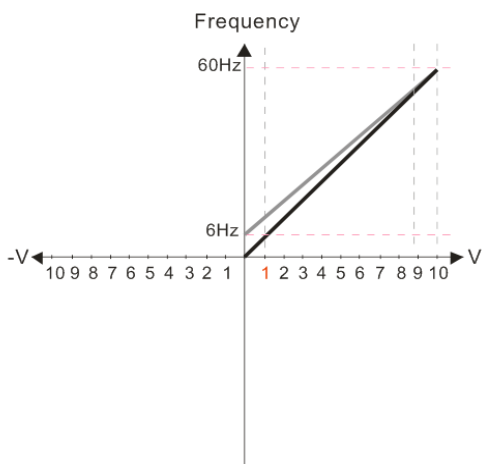

Pr.03-07~03-09 (Positive/Negative Bias Mode)

- 0: No bias
- 1: Lower than or equal to bias
- 2: Greater than or equal to bias
- 3: The absolute value of the bias voltage while serving as the center
- 4: Serve bias as the center

Pr.03-10 (Analog Frequency Command for Reverse Run)

- 0: Negative frequency is not valid. Forward and reverse run is controlled by digital keypad or external terminal.
- 1: Negative frequency is valid. Positive frequency = forward run; negative frequency = reverse run. Direction can not be switched by digital keypad or external terminal control.

Calculate the bias: $\frac{60-6\text{Hz}}{10\text{V}} = \frac{6-0\text{Hz}}{(0-X\text{V})}$ $X\text{V} = \frac{10}{-9} = -1.11\text{V}$
 $\therefore \text{Pr.03-03} = \frac{-1.11}{10} \times 100\% = -11.1\%$

Calculate the gain: $\text{Pr.03-11} = \frac{10\text{V}}{11.1\text{V}} \times 100\% = 90.0\%$

33.

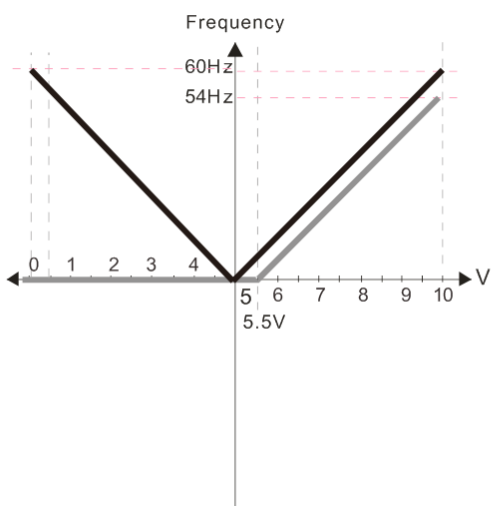

Pr.00-21=0 (Digital keypad control and d run in FWD direction)

Pr.03-05 Analog Positive Voltage Input Bias (AVI2) = 10%

Pr.03-07~03-09 (Positive/Negative Bias Mode)

- 0: No bias
- 1: Lower than or equal to bias
- 2: Greater than or equal to bias
- 3: The absolute value of the bias voltage while serving as the center
- 4: Serve bias as the center

Pr.03-10 (Analog Frequency Command for Reverse Run)

- 0: Negative frequency is not valid. Forward and reverse run is controlled by digital keypad or external terminal.
- 1: Negative frequency is valid. Positive frequency forward run; negative frequency reverse run. Direction cannot be switched by digital keypad or external terminal control.

Pr.03-13 Analog Input Gain 3 (AVI2) = 100%

Pr.03-14 Analog Input Gain 4 (AVI2) = 100%

34.

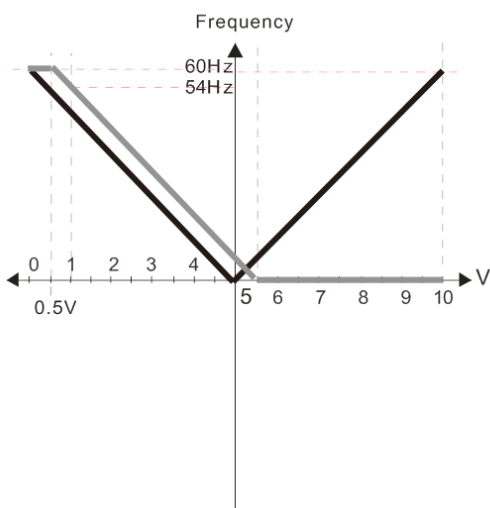

Pr.00-21=0 (Digital keypad control and d run in FWD direction)

Pr.03-05 Analog Positive Voltage Input Bias (AVI2) = 10%

Pr.03-07~03-09 (Positive/Negative Bias Mode)

- 0: No bias
- 1: Lower than or equal to bias
- 2: Greater than or equal to bias
- 3: The absolute value of the bias voltage while serving as the center
- 4: Serve bias as the center

Pr.03-10 (Analog Frequency Command for Reverse Run)

- 0: Negative frequency is not valid. Forward and reverse run is controlled by digital keypad or external terminal.
- 1: Negative frequency is valid. Positive frequency forward run; negative frequency reverse run. Direction cannot be switched by digital keypad or external terminal control.

Pr.03-13 Analog Input Gain 3 (AVI2) = 100%

Pr.03-14 Analog Input Gain 4 (AVI2) = 100%

35.

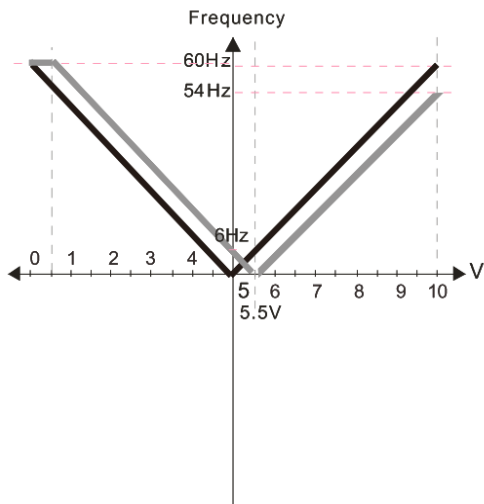

- Pr.00-21=0 (Digital keypad control and d run in FWD direction)
- Pr.03-05 Analog Positive Voltage Input Bias (AVI2) =10%
- Pr.03-07~03-09 (Positive/Negative Bias Mode)
 - 0: No bias
 - 1: Lower than or equal to bias
 - 2: Greater than or equal to bias
 - 3: The absolute value of the bias voltage while serving as the center
 - 4: Serve bias as the center
- Pr.03-10 (Analog Frequency Command for Reverse Run)
 - 0: Negative frequency is not valid. Forward and reverse run is controlled by digital keypad or external terminal.
 - 1: Negative frequency is valid. Positive frequency forward run; negative frequency reverse run. Direction cannot be switched by digital keypad or external terminal control
- Pr.03-13 Analog Input Gain 3 (AVI2)= 100%
- Pr.03-14 Analog Input Gain 4 (AVI2)= 100%

36.

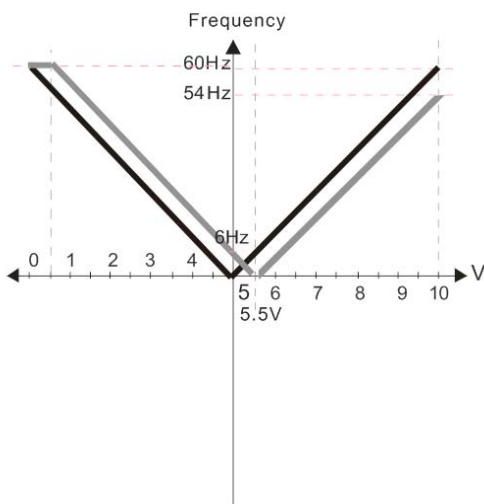

- Pr.00-21=0 (Digital keypad control and d run in FWD direction)
- Pr.03-05 Analog Positive Voltage Input Bias (AVI2) =10%
- Pr.03-07~03-09 (Positive/Negative Bias Mode)
 - 0: No bias
 - 1: Lower than or equal to bias
 - 2: Greater than or equal to bias
 - 3: The absolute value of the bias voltage while serving as the center
 - 4: Serve bias as the center
- Pr.03-10 (Analog Frequency Command for Reverse Run)
 - 0: Negative frequency is not valid. Forward and reverse run is controlled by digital keypad or external terminal.
 - 1: Negative frequency is valid. Positive frequency forward run; negative frequency reverse run. Direction cannot be switched by digital keypad or external terminal control
- Pr.03-13 Analog Input Gain 3 (AVI2)= 100%
- Pr.03-14 Analog Input Gain 4 (AVI2)= 100%

37.

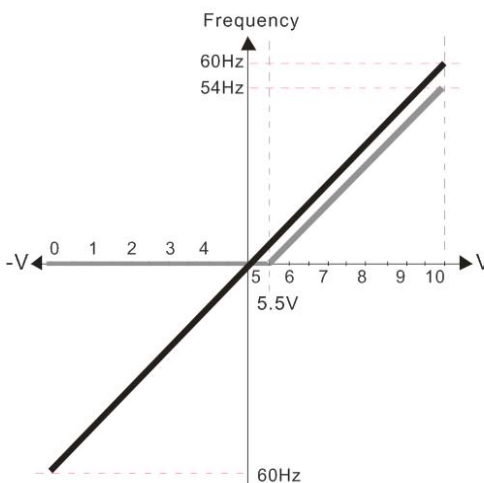

- Pr.00-21=0 (Digital keypad control and d run in FWD direction)
- Pr.03-05 Analog Positive Voltage Input Bias (AVI2) =10%
- Pr.03-07~03-09 (Positive/Negative Bias Mode)
 - 0: No bias
 - 1: Lower than or equal to bias
 - 2: Greater than or equal to bias
 - 3: The absolute value of the bias voltage while serving as the center
 - 4: Serve bias as the center
- Pr.03-10 (Analog Frequency Command for Reverse Run)
 - 0: Negative frequency is not valid. Forward and reverse run is controlled by digital keypad or external terminal.
 - 1: Negative frequency is valid. Positive frequency forward run; negative frequency reverse run. Direction cannot be switched by digital keypad or external terminal control
- Pr.03-13 Analog Input Gain 3 (AVI2)= 100%
- Pr.03-14 Analog Input Gain 4 (AVI2)= 100%

38.

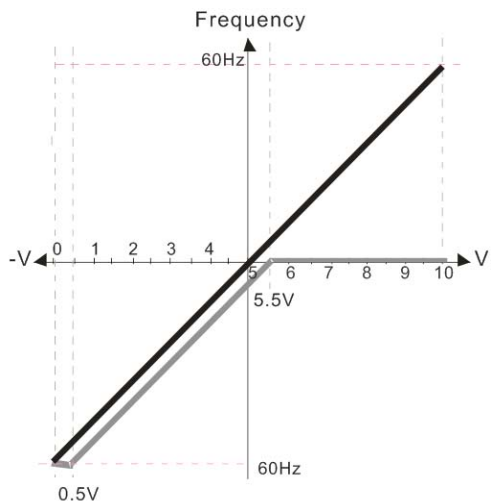

Pr.00-21=0 (Digital keypad control and run in FWD direction)
 Pr.03-05 Analog Positive Voltage Input Bias (AVI2) = 10%
 Pr.03-07~03-09 (Positive/Negative Bias Mode)

- 0: No bias
- 1: Lower than or equal to bias
- 2: Greater than or equal to bias
- 3: The absolute value of the bias voltage while serving as the center
- 4: Serve bias as the center

Pr.03-10 (Analog Frequency Command for Reverse Run)

- 0: Negative frequency is not valid. Forward and reverse run is controlled by digital keypad or external terminal.
- 1: Negative frequency is valid. Positive frequency = forward run; negative frequency = reverse run. Direction can not be switched by digital keypad or external terminal control.

Pr.03-13 Analog Input Gain 3 (AVI2)= 100%
 Pr.03-14 Analog Input Gain 4 (AVI2)= 100%

39.

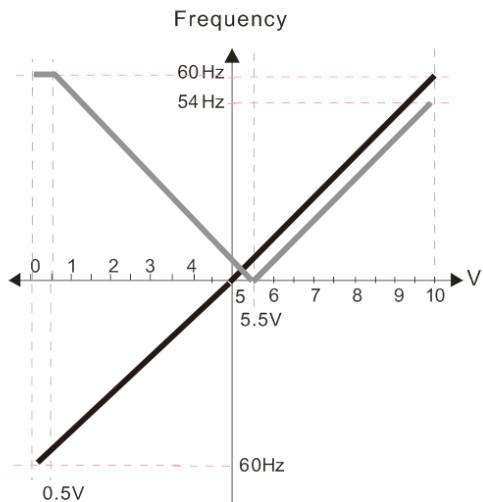

Pr.00-21=0 (Digital keypad control and run in FWD direction)
 Pr.03-05 Analog Positive Voltage Input Bias (AVI2) = 10%
 Pr.03-07~03-09 (Positive/Negative Bias Mode)

- 0: No bias
- 1: Lower than or equal to bias
- 2: Greater than or equal to bias
- 3: The absolute value of the bias voltage while serving as the center
- 4: Serve bias as the center

Pr.03-10 (Analog Frequency Command for Reverse Run)

- 0: Negative frequency is not valid. Forward and reverse run is controlled by digital keypad or external terminal.
- 1: Negative frequency is valid. Positive frequency = forward run; negative frequency = reverse run. Direction can not be switched by digital keypad or external terminal control.

Pr.03-13 Analog Input Gain 3 (AVI2)= 100%
 Pr.03-14 Analog Input Gain 4 (AVI2)= 100%

40.

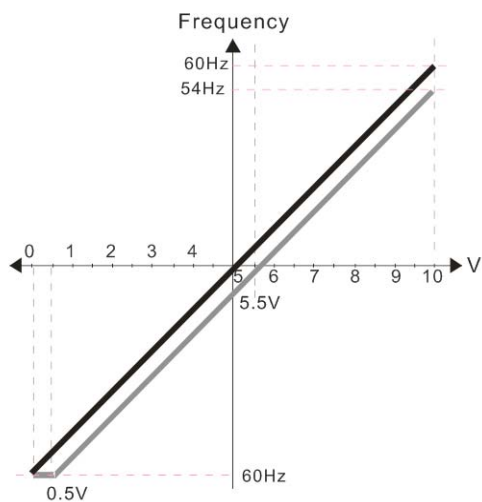

Pr.00-21=0 (Digital keypad control and run in FWD direction)
 Pr.03-05 Analog Positive Voltage Input Bias (AVI2) = 10%
 Pr.03-07~03-09 (Positive/Negative Bias Mode)

- 0: No bias
- 1: Lower than or equal to bias
- 2: Greater than or equal to bias
- 3: The absolute value of the bias voltage while serving as the center
- 4: Serve bias as the center

Pr.03-10 (Analog Frequency Command for Reverse Run)

- 0: Negative frequency is not valid. Forward and reverse run is controlled by digital keypad or external terminal.
- 1: Negative frequency is valid. Positive frequency = forward run; negative frequency = reverse run. Direction can not be switched by digital keypad or external terminal control.

Pr.03-13 Analog Input Gain 3 (AVI2)= 100%
 Pr.03-14 Analog Input Gain 4 (AVI2)= 100%

41.

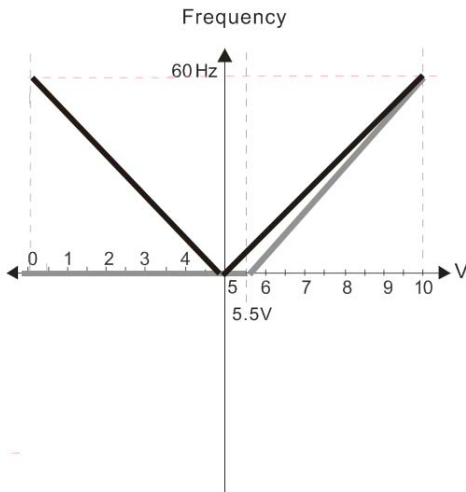

Pr.00-21=0 (Digital keypad control and run in FWD direction)
 Pr.03-05 Analog Positive Voltage Input Bias (AVI2) = 10%
 Pr.03-07~03-09 (Positive/Negative Bias Mode)

- 0: No bias
- 1: Lower than or equal to bias
- 2: Greater than or equal to bias
- 3: The absolute value of the bias voltage while serving as the center
- 4: Serve bias as the center

Pr.03-10 (Analog Frequency Command for Reverse Run)

- 0: Negative frequency is not valid. Forward and reverse run is controlled by digital keypad or external terminal.
- 1: Negative frequency is valid. Positive frequency = forward run; negative frequency = reverse run. Direction can not be switched by digital keypad or external terminal control.

Pr.03-13 Analog Input Gain 3 (AVI2)= 111.1%
 $(10/9) * 100\% = 111.1\%$

Pr.03-14 Analog Input Gain 4 (AVI2) = 111.1%

42.

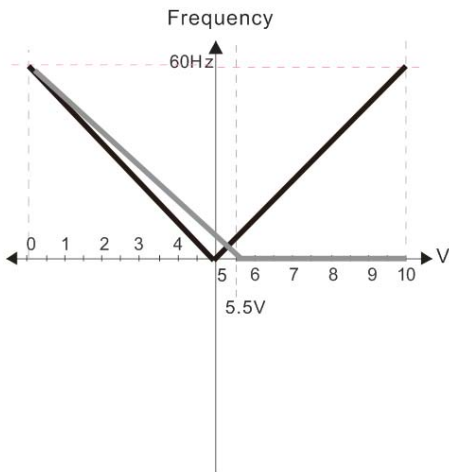

Pr.00-21=0 (Digital keypad control and run in FWD direction)
 Pr.03-05 Analog Positive Voltage Input Bias (AVI2) = 10%
 Pr.03-07~03-09 (Positive/Negative Bias Mode)

- 0: No bias
- 1: Lower than or equal to bias
- 2: Greater than or equal to bias
- 3: The absolute value of the bias voltage while serving as the center
- 4: Serve bias as the center

Pr.03-10 (Analog Frequency Command for Reverse Run)

- 0: Negative frequency is not valid. Forward and reverse run is controlled by digital keypad or external terminal.
- 1: Negative frequency is valid. Positive frequency = forward run; negative frequency = reverse run. Direction can not be switched by digital keypad or external terminal control.

Pr.03-13 Analog Input Gain 3 (AVI2)= 100%

Pr.03-14 Analog Input Gain 4 (AVI2) = 90.9%
 $(10/11) * 100\% = 90.9\%$

43.

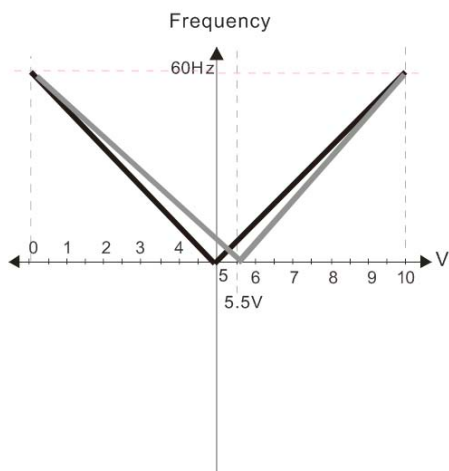

Pr.00-21=0 (Digital keypad control and run in FWD direction)
 Pr.03-05 Analog Positive Voltage Input Bias (AVI2) = 10%
 Pr.03-07~03-09 (Positive/Negative Bias Mode)

- 0: No bias
- 1: Lower than or equal to bias
- 2: Greater than or equal to bias
- 3: The absolute value of the bias voltage while serving as the center
- 4: Serve bias as the center

Pr.03-10 (Analog Frequency Command for Reverse Run)

- 0: Negative frequency is not valid. Forward and reverse run is controlled by digital keypad or external terminal.
- 1: Negative frequency is valid. Positive frequency = forward run; negative frequency = reverse run. Direction can not be switched by digital keypad or external terminal control.

Pr.03-13 Analog Input Gain 3 (AVI2)= 111.1%
 $(10/9) * 100\% = 111.1\%$

Pr.03-14 Analog Input Gain 4 (AVI2) = 90.9%
 $(10/11) * 100\% = 90.9\%$

44.

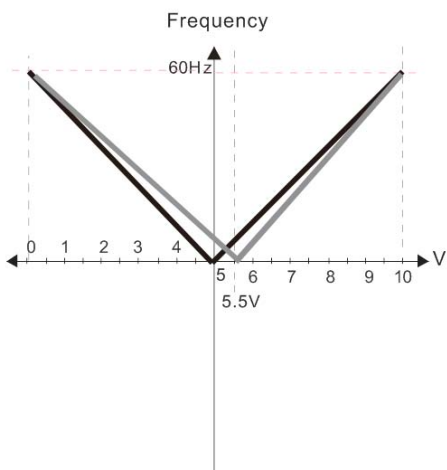

- Pr.00-21=0 (Digital keypad control and run in FWD direction)
- Pr.03-05 Analog Positive Voltage Input Bias (AVI2) = 10%
- Pr.03-07~03-09 (Positive/Negative Bias Mode)
 - 0: No bias
 - 1: Lower than or equal to bias
 - 2: Greater than or equal to bias
 - 3: The absolute value of the bias voltage while serving as the center
 - 4: Serve bias as the center

- Pr.03-10 (Analog Frequency Command for Reverse Run)
 - 0: Negative frequency is not valid. Forward and reverse run is controlled by digital keypad or external terminal.
 - 1: Negative frequency is valid. Positive frequency = forward run; negative frequency = reverse run. Direction can not be switched by digital keypad or external terminal control.

- Pr.03-13 Analog Input Gain 3 (AVI2)= 111.1%
 $(10/9) * 100\% = 111.1\%$
- Pr.03-14 Analog Input Gain 4 (AVI2) = 90.9%
 $(10/11) * 100\% = 90.9\%$

45.

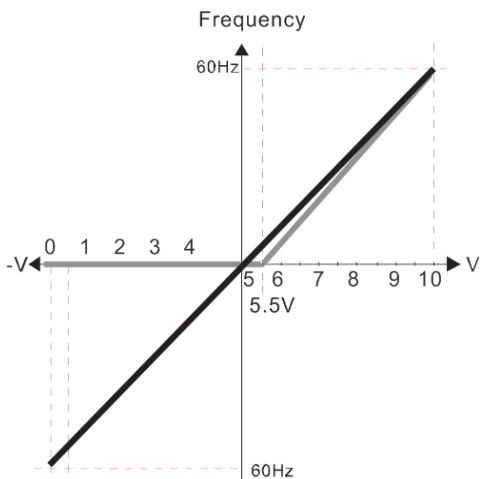

- Pr.00-21=0 (Digital keypad control and run in FWD direction)
- Pr.03-05 Analog Positive Voltage Input Bias (AVI2) = 10%
- Pr.03-07~03-09 (Positive/Negative Bias Mode)
 - 0: No bias
 - 1: Lower than or equal to bias
 - 2: Greater than or equal to bias
 - 3: The absolute value of the bias voltage while serving as the center
 - 4: Serve bias as the center

- Pr.03-10 (Analog Frequency Command for Reverse Run)
 - 0: Negative frequency is not valid. Forward and reverse run is controlled by digital keypad or external terminal.
 - 1: Negative frequency is valid. Positive frequency = forward run; negative frequency = reverse run. Direction can not be switched by digital keypad or external terminal control.

- Pr.03-13 Analog Input Gain 3 (AVI2)= 111.1%
 $(10/9) * 100\% = 111.1\%$
- Pr.03-14 Analog Input Gain 4 (AVI2) = 100%

46.

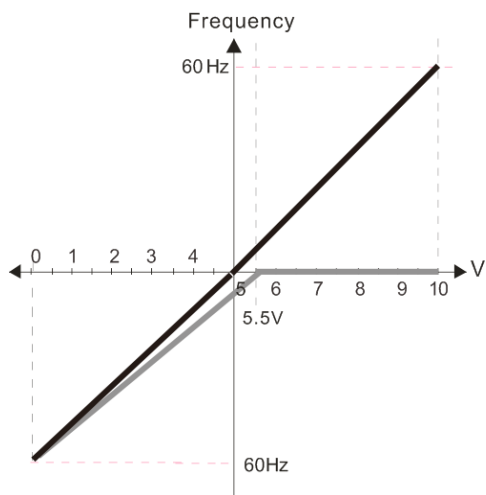

- Pr.00-21=0 (Digital keypad control and run in FWD direction)
- Pr.03-05 Analog Positive Voltage Input Bias (AVI2) = 10%
- Pr.03-07~03-09 (Positive/Negative Bias Mode)
 - 0: No bias
 - 1: Lower than or equal to bias
 - 2: Greater than or equal to bias
 - 3: The absolute value of the bias voltage while serving as the center
 - 4: Serve bias as the center

- Pr.03-10 (Analog Frequency Command for Reverse Run)
 - 0: Negative frequency is not valid. Forward and reverse run is controlled by digital keypad or external terminal.
 - 1: Negative frequency is valid. Positive frequency = forward run; negative frequency = reverse run. Direction can not be switched by digital keypad or external terminal control.

- Pr.03-13 Analog Input Gain 3 (AVI2)= 100%
- Pr.03-14 Analog Input Gain 4 (AVI2) = 90.9%
 $(10/11) * 100\% = 90.9\%$

47.

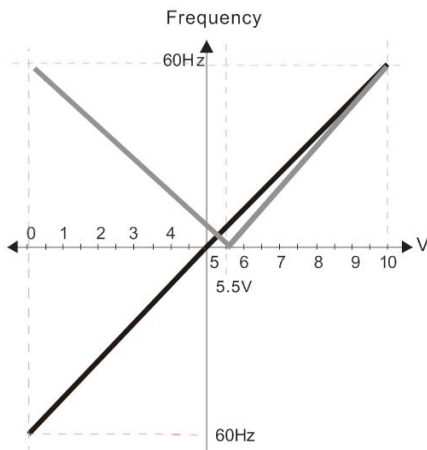

Pr.00-21=0 (Digital keypad control and run in FWD direction)
 Pr.03-05 Analog Positive Voltage Input Bias (AVI2) = 10%
 Pr.03-07~03-09 (Positive/Negative Bias Mode)
 0: No bias
 1: Lower than or equal to bias
 2: Greater than or equal to bias
 3: The absolute value of the bias voltage while serving as the center
 4: Serve bias as the center

Pr.03-10 (Analog Frequency Command for Reverse Run)
 0: Negative frequency is not valid. Forward and reverse run is controlled by digital keypad or external terminal.
 1: Negative frequency is valid. Positive frequency = forward run; negative frequency = reverse run. Direction can not be switched by digital keypad or external terminal control.

Pr.03-13 Analog Input Gain 3 (AVI2)= 111.1%
 $(10/9) * 100\% = 111.1\%$
 Pr.03-14 Analog Input Gain 4 (AVI2) = 90.9%
 $(10/11) * 100\% = 90.9\%$

48.

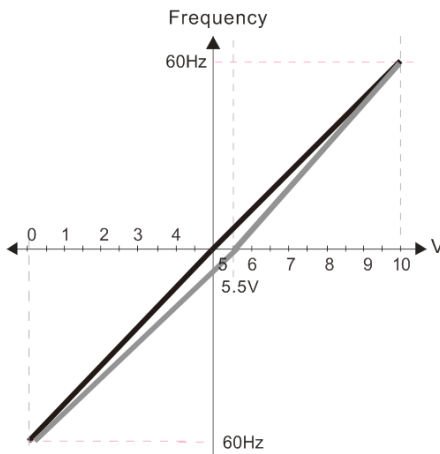

Pr.00-21=0 (Digital keypad control and run in FWD direction)
 Pr.03-05 Analog Positive Voltage Input Bias (AVI2) = 10%
 Pr.03-07~03-09 (Positive/Negative Bias Mode)
 0: No bias
 1: Lower than or equal to bias
 2: Greater than or equal to bias
 3: The absolute value of the bias voltage while serving as the center
 4: Serve bias as the center

Pr.03-10 (Analog Frequency Command for Reverse Run)
 0: Negative frequency is not valid. Forward and reverse run is controlled by digital keypad or external terminal.
 1: Negative frequency is valid. Positive frequency = forward run; negative frequency = reverse run. Direction can not be switched by digital keypad or external terminal control.

Pr.03-13 Analog Input Gain 3 (AVI2)= 111.1%
 $(10/9) * 100\% = 111.1\%$
 Pr.03-14 Analog Input Gain 4 (AVI2) = 90.9%
 $(10/11) * 100\% = 90.9\%$

↗	03-11	Analog Input Gain (AVI1)
↗	03-12	Analog Input Gain (ACI)
↗	03-13	Analog Positive Input Gain (AVI2)
↗	03-14	Analog Negative Input Gain (AVI2)

Factory Setting: 100.0

Settings -500.0~500.0%

📖 Parameters 03-03 to 03-14 are used when the source of frequency command is the analog voltage/current signal.

↗	03-15	Analog Input Filter Time (AVI1)
↗	03-16	Analog Input Filter Time (ACI)
↗	03-17	Analog Input Filter Time (AVI2)

Factory Setting: 0.01

Settings 0.00~20.00 sec

📖 These input delays can be used to filter noisy analog signal.

- When the setting of the time constant is too large, the control will be stable but the control response will be slow. When the setting of time constant is too small, the control response will be faster but the control may be unstable. To find the optimal setting, please adjust the setting according to the control stable or response status.

03-18 Addition Function of the Analog Input

Factory Setting: 0

Settings 0: Disable (AVI1, ACI, AVI2)

1: Enable

- When Pr03-18 is set to 1:

EX1: Pr03-00=Pr03-01=1 Frequency command= AVI1+ACI

EX2: Pr03-00=Pr03-01=Pr03-02=1 Frequency command = AVI1+ACI+AVI2

EX3: Pr03-00=Pr03-02=1 Frequency command = AVI1+AVI2

EX4: Pr03-01=Pr03-02=1 Frequency command = ACI+AVI2

- When Pr.03-18 is set to 0 and the analog input setting is the same, the priority for AVI1, ACI and AVI2 are AVI1>ACI>AVI2.

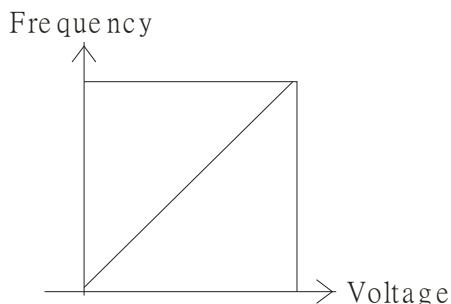

$$F_{\text{command}} = [(\text{ay} - \text{bias}) * \text{gain}] * \frac{F_{\text{max}}(01-00)}{10\text{V or } 16\text{mA or } 20\text{mA}}$$

F_{command} : the corresponding frequency for 10V or 20mA
 ay : 0-10V, 4-20mA, 0-20mA
 bias : Pr.03-03, Pr.03-04, Pr.03-05
 gain : Pr.03-11, Pr.03-12, Pr.03-13, Pr.03-14

03-19 Treatment to 4~20mA Analog Input Signal Loss

Factory Setting: 0

Settings 0: Disable

1: Continue operation at the last frequency

2: Decelerate to stop

3: Stop immediately and display ACE

- This parameter determines the behavior when 4~20mA signal is loss, when AVIc (Pr.03-28=2) or ACIc (03-29=0).
- When Pr.03-28 is not set to 2, it means the voltage input to AVI terminal is 0~10V or 0~20mA. At this moment, Pr.03-19 will be invalid.
- When Pr.03-29 is set to 1, it means the voltage input to ACI terminal is for 0~10V. At this moment, Pr.03-19 will be invalid.
- When setting is 1 or 2, it will display warning code "AnL" on the keypad. It will be blinking until the loss of the ACI signal is recovered.
- When the motor drive stops, the condition of warning does not exist, then the warning will disappear.

- 03-20 Multi-function Output 1 (AFM1)

Factory Setting: 0
- 03-23 Multi-function Output 2 (AFM2)

Factory Setting: 0

Settings 0~23

Function Chart

Settings	Functions	Descriptions
0	Output frequency (Hz)	Max. frequency Pr.01-00 is regarded as 100%.
1	Frequency command (Hz)	Max. frequency Pr.01-00 is regarded as 100%.
2	Motor speed (Hz)	Max. frequency Pr.01-00 is regarded as 100%.
3	Output current (rms)	(2.5 X rated current) is regarded as 100%
4	Output voltage	(2 X rated voltage) is regarded as 100%
5	DC Bus Voltage	450V (900V)=100%
6	Power factor	-1.000~1.000=100%
7	Power	Rated power is regarded as 100%
9	AVI1	0~10V/ 0~20mA/ 4~20mA =0~100%
10	ACI	4~20mA/ 0~10V/ 0~20mA =0~100%
11	AVI2	0~10V/ 0~20mA/ 4~20mA =0~100%
20	Output for CANopen control	For CANopen analog output
21	RS485 analog output	Provide InnerCOM internal communication as control of communication output
22	Analog output for communication card	For communication output (CMC-MOD01, CMC-EIP01, CMC-PN01, CMC-DN01)
23	Constant voltage/current output	Pr.03-32 and Pr.03-33 controls voltage/current output level 0~100% of Pr.03-32 corresponds to 0~10V of AFM1. 0~100% of Pr.03-33 corresponds to 0~10V of AFM2.

- 03-21 Gain of Analog Output 1 (AFM1)

Factory Setting: 100.0
- 03-24 Gain of Analog Output 2 (AFM2)

Factory Setting: 100.0

Settings 0~500.0%

- It is used to adjust the analog voltage level (Pr.03-20) that terminal AFM outputs.
- This parameter is set the corresponding voltage of the analog output 0.

- 03-22 Analog Output 1 when in REV Direction (AFM1)

Factory Setting: 0
- 03-25 Analog Output 2 when in REV Direction (AFM2)

Factory Setting: 0

Settings 0: Absolute value in REV direction
 1: Output 0V in REV direction; output 0~10V in FWD direction
 2: Output 5~0V in REV direction; output 5~10V in FWD direction

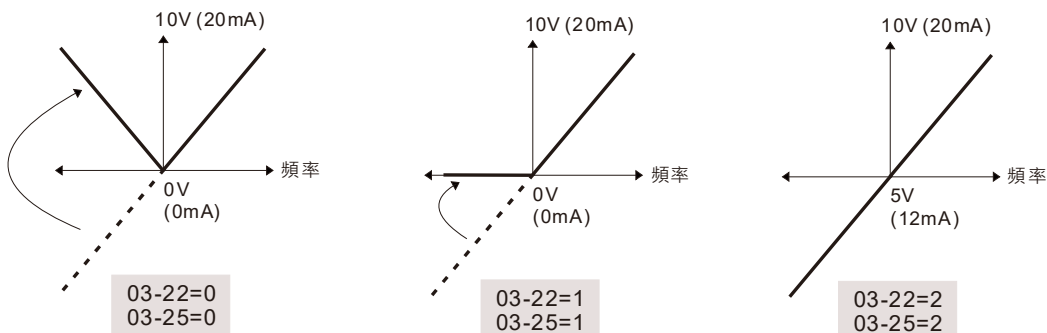

Selections for the analog output direction

03-27 AFM2 Output Bias

Factory Setting: 0.00

Settings -100.00~100.00%

Example 1, AFM2, 0~10V is set output frequency, the output equation is

$$10V \times \left(\frac{\text{Output Frequency}}{01-00} \right) \times 03-24 + 10V \times 03-27$$

Example 2, AFM2, 0~20mA is set output frequency, the output equation is

$$20mA \times \left(\frac{\text{Output Frequency}}{01-00} \right) \times 03-24 + 20mA \times 03-27$$

Example 3, AFM2, 4~20mA is set output frequency, the output equation is

$$4mA + 16mA \times \left(\frac{\text{Output Frequency}}{01-00} \right) \times 03-24 + 16mA \times 03-27$$

This parameter can set the corresponded voltage of 0 for analog output.

03-28 AVI1 Selection

Factory Setting: 0

Settings 0: 0~10V

1: 0~20mA

2: 4~20mA

03-29 ACI Selection

Factory Setting: 0

Settings 0: 4~20mA

1: 0~10V

2: 0~20mA

When changing the input mode, please check if the switch of external terminal (SW3, SW4) corresponds to the setting of Pr.03-28~03-29.

03-30 Status of PLC Output Terminal

Factory Setting: Read only

Settings 0~65535

Monitor the status of PLC analog output terminals

P.03-30 shows the external multi-function output terminal that used by PLC.

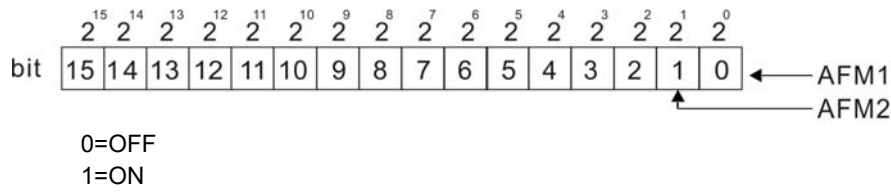

Note			
$2^{15} = 32768$	$2^{14} = 16384$	$2^{13} = 8192$	
$2^{12} = 4096$	$2^{11} = 2048$	$2^{10} = 1024$	
$2^9 = 512$	$2^8 = 256$	$2^7 = 128$	
$2^6 = 64$	$2^5 = 32$	$2^4 = 16$	
$2^3 = 8$	$2^2 = 4$	$2^1 = 2$	$2^0 = 1$

For Example:

If the value of Pr.03-30 displays 0002h (Hex), it means AFM1 and AFM2 are used by PLC.

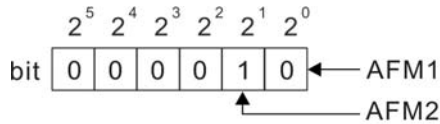

Setting
= bit 1 x 2¹ + bit 0 x 2⁰
= 1 + 1
= 2

Note		
$2^5 = 32$	$2^4 = 16$	$2^3 = 8$
$2^2 = 4$	$2^1 = 2$	$2^0 = 1$

✎ **03-31** AFM2 Output Selection

✎ **03-34** AFM1 Output Selection

Factory Setting: 0

Settings 0: 0~20mA output
1: 4~20mA output

✎ **03-32** AFM1 DC output setting level

✎ **03-33** AFM2 DC Output Setting Level

Factory Setting: 0.00

Settings 0.00~100.00%

- 📖 Pair with Multi-Function Output : 23, Pr03-32 and Pr03-33 can output constant AFM voltage.
- 📖 Set Pr03-32 between 0 to 100%.00 to correspond to 0~10V of AFM1
- 📖 Set Pr03-33 between 0 to 100.00 % to correspond to 0~10V of AFM2

✎ **03-35** AFM1 Filter Output Time

✎ **03-36** AFM2 Filter Output Time

Factory Setting: 0.01

Settings 0.00~20.00 sec.

✎ **03-44** MO by AI level

Factory Setting: 0

Settings 0: AVI1
1: ACI
2: AVI2

✎ **03-45** MO Output by Source of AI Upper level

Factory Setting: 50.00%

Settings -100.00%~100.00%

✎ **03-46** MO Output by Source of AI Lower level

Factory Setting: 100.00%

Settings -100.00%~100.00%

- 📖 This function requires working with Multi-function Output item “67” Analog signal level achieved. The MO active when AI input level is higher than Pr. 03-45 AI Upper level. The MO shutoffs when the AI input is lower than Pr. 03-46 AI Lower level.
- 📖 AI Upper level (Pr. 03-45) must be higher than AI Lower level (Pr. 03-46).

🔪 03-50 Analog Input Curve Selection

Factory Setting: 0

- Settings
- 0: Regular Curve
 - 1: 3 point curve of AVI1
 - 2: 3 point curve of ACI
 - 3: 3 point curve of AVI 1& ACI
 - 4: 3 point curve of AVI2
 - 5: 3 point curve of AVI 1& AVI2
 - 6: 3 point curve of ACI & AVI2
 - 7: 3 point curve of AVI1 & ACI & AVI2

- 📖 This parameter calculates by analog input.
- 📖 Set Pr03-50 = 0, all analog input signal are calculated by using bias and gain.
- 📖 Set Pr03-50 =1, AVI1 is calculated by using frequency and voltage/current in corresponding format (Pr03-51 ~ Pr03-56), other analog input signals are calculated by using bias and gain.
- 📖 Set Pr03-50 =2, ACI is calculated by using frequency and voltage/current in corresponding format (Pr03-57 ~ Pr03-62), other analog input signals are calculated by using bias and gain.
- 📖 Set Pr03-50 =3, AVI1 and ACI are calculated by using frequency and voltage/current in corresponding format (Pr03-51 ~ Pr03-62), other analog input signals are calculated by using bias and gain.
- 📖 Set Pr03-50 =4, AVI2 is calculated by using frequency and voltage in corresponding format (Pr03-63 ~ Pr03-68), other analog input signals are calculated by using bias and gain.
- 📖 Set Pr03-50=5, AVI1 and AVI2 are calculated by using frequency and voltage/current in corresponding format (Pr03-51~ Pr03-5, Pr03-63~Pr03-68), other analog input signal are calculated by using bias and gain.
- 📖 Set Pr03-50=6, ACI and AVI2 are calculated by using frequency and voltage/current in corresponding format (Pr03-57 ~ Pr03-68), other analog input signals are calculated by using bias and gain.
- 📖 Set Pr03-50=7, all the analog input signals are calculated by using frequency and voltage/current in corresponding format (Pr03-51 ~ Pr03-68)

🔪 03-51 AVI1 Low Point

Factory Setting: 0.00

- Settings
- 03-28=0, 0.00~10.00V
 - 03-28≠0, 0.00~20.00mA

🔪 03-52 AVI1 Proportional Low Point

Factory Setting: 0.00

- Settings
- 100.00~100.00%

- 03-53 AVI1 Mid-Point Factory Setting: 5.00
 Settings 03-28=0, 0.00~10.00V
 03-28≠0, 0.00~20.00mA
- 03-54 AVI1 Proportional Mid-Point Factory Setting: 50.00
 Settings -100.00~100.00%
- 03-55 AVI1 High Point Factory Setting: 10.00
 Settings 03-28=0, 0.00~10.00V
 03-28≠0, 0.00~20.00mA
- 03-56 AVI1 Proportional High Point Factory Setting: 100.00
 Settings -100.00~100.00%

- 📖 When Pr.03-28 = 0, AVI1 setting is 0~10V and the unit is in voltage (V).
- 📖 When Pr.03-28 ≠ 0, AVI1 setting is 0~20mA or 4~20mA and the unit is in current (mA).
- 📖 When setting analog input AVI1 to frequency command, it 100% corresponds to Fmax (Pr.01-00 Max. operation frequency).
- 📖 The 3 parameters (Pr03-51, Pr03-53 and Pr03-55) must meet the following argument: P03-51 < P03-53 < P03-55. The 3 proportional points (Pr03-52, Pr03-54 and Pr03-56) doesn't have any limit. Between two points is a linear calculation. The ACI and AVI2 are same as AVI1.
- 📖 The output % will become 0% when the AVI1 input value is lower than low point setting. For example: Pr.03-51=1V, Pr.03-52=10%, below (including) 1V all output 0%. If the value beats between 1V and 1.1V, the output frequency of driver will beat between 0%~10%.

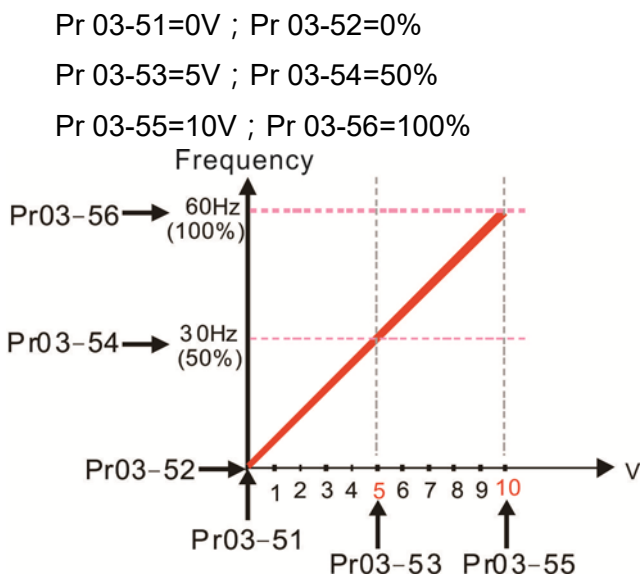

Pr 03-51=1V ; Pr 03-52=10%
 Pr 03-53=5V ; Pr 03-54=50%
 Pr 03-55=10V ; Pr 03-56=100%

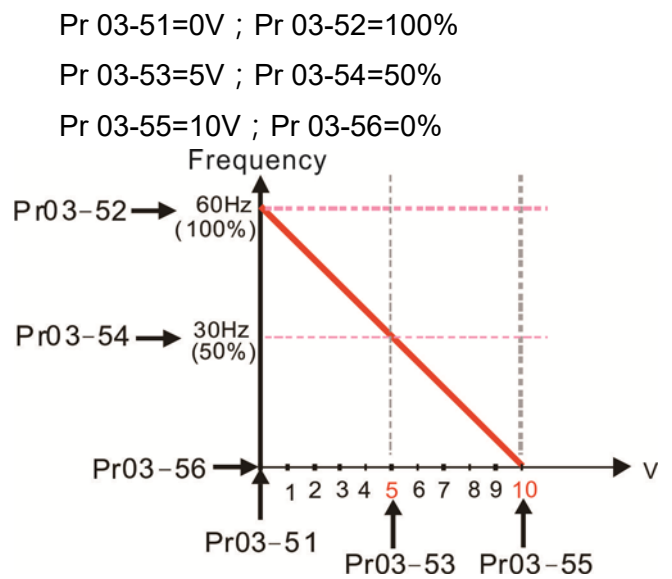

Pr 03-51=1V ; Pr 03-52=10%
 Pr 03-53=5V ; Pr 03-54=50%
 Pr 03-55=9V ; Pr 03-56=100%

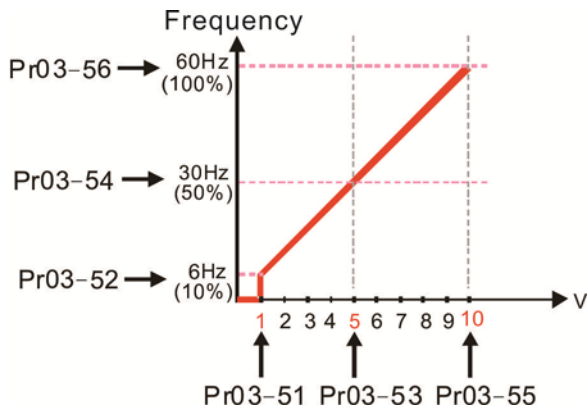

Pr 03-51=0V ; Pr 03-52=10%
 Pr 03-53=5V ; Pr 03-54=50%
 Pr 03-55=10V ; Pr 03-56=100%

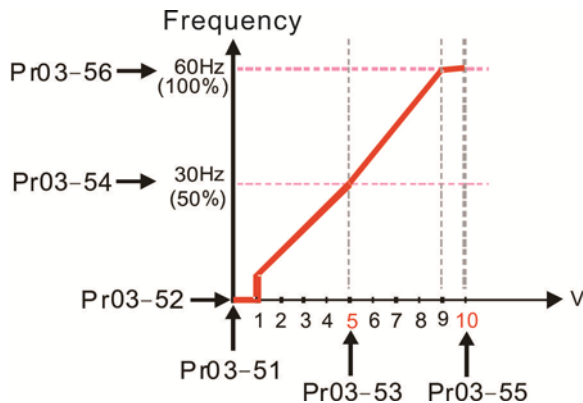

Pr 03-51=1V ; Pr 03-52=0%
 Pr 03-53=5V ; Pr 03-54=50%
 Pr 03-55=10V ; Pr 03-56=100%

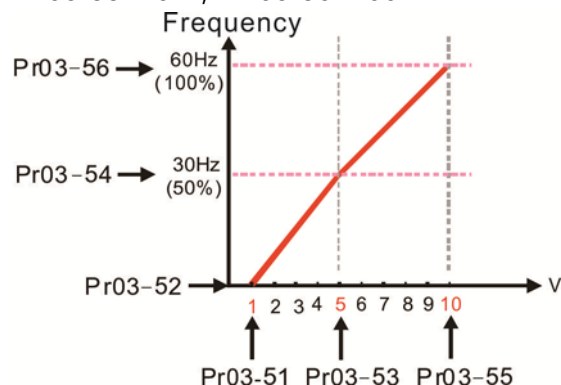
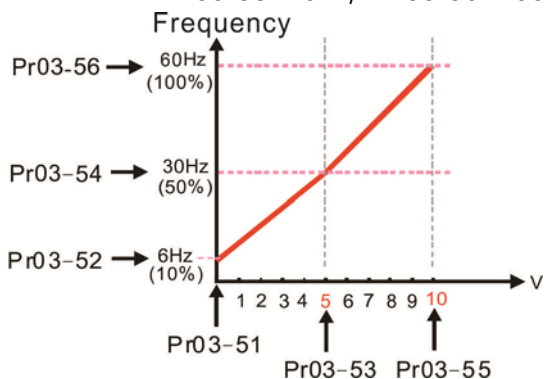

✎ **03-57** ACI Low Point

Factory Setting: 4.00

Settings Pr.03-29=1, 0.00~10.00V
 Pr.03-29≠1, 0.00~20.00mA

✎ **03-58** ACI Proportional Low Point

Factory Setting: 0.00

Settings -100.00~100.00%

✎ **03-59** ACI Mid-Point

Factory Setting: 12.00

Settings 03-29=1, 0.00~10.00V
 03-29≠1, 0.00~20.00mA

✎ **03-60** ACI Proportional Mid-Point

Factory Setting: 50.00

Settings -100.00~100.00%

✎ **03-61** ACI High Point

Factory Setting: 20.00

Settings 03-29=1, 0.00~10.00V
 03-29≠1, 0.00~20.00mA

↗ **03-62** ACI Proportional High Point Factory Setting: 100.00

Settings -100.00~100.00%

- 📖 When Pr.03-29=1, ACI setting is 0~10V and the unit is in voltage (V).
- 📖 When Pr.03-29≠1, ACI setting is 0~20mA or 4~20mA and the unit is in current (mA).
- 📖 When setting analog input ACI to frequency command, it 100% corresponds to Fmax (Pr.01-00 Max. operation frequency).
- 📖 The 3 parameters (Pr03-57, Pr03-59 and Pr03-61) must meet the following argument: P03-57 < P03-59 < P03-61. The 3 proportional points (Pr03-58, Pr03-60 and Pr03-62) doesn't have any limit. Between two points is a linear calculation.
- 📖 The output % will become 0% when the ACI input value is lower than low point setting.
For example:
P03-57 = 2mA; P03-58 = 10%. The output will become 0% when AVI1 input is lower than 2mA. If the ACI input is swing between 2mA and 2.1mA, drive's output frequency will beat between 0% and 10%.

↗ **03-63** Positive AVI2 Voltage Low Point Factory Setting: 0.00

Settings 0.00~10.00V

↗ **03-64** Positive AVI2 Voltage Proportional Low Point Factory Setting: 0.00

Settings -100.00%~100.00%

↗ **03-65** Positive AVI2 Voltage Mid-Point Factory Setting: 5.00

Settings 0.00~10.00V

↗ **03-66** Positive AVI2 Voltage Proportional Mid Point Factory Setting: 50.00

Settings -100.00%~100.00%

↗ **03-67** Positive AVI2 Voltage High Point Factory Setting: 10.00

Settings 0.00~10.00V

↗ **03-68** Positive AVI2 Voltage Proportional High Point Factory Setting: 100.00

Settings -100.00%~100.00%

- 📖 When AVI2 Selection (Pr03-28) is AVI1, the setting range of Pr03-51, Pr03-52, Pr03-55 have to be 0.00~10.00 or 0.00~20.00.
- 📖 When ACI Selection (Pr03-29) is AVI1, the setting range of Pr03-57, Pr03-59 and Pr03-61 have to be 0.00~10.00 or 0.00~20.00.
- 📖 The analog input values can be set at Pr03-51 ~ Pr03-68 and the maximum operating frequency can be set at Pr01-00. The corresponding functions of open-loop control are shown as image below.

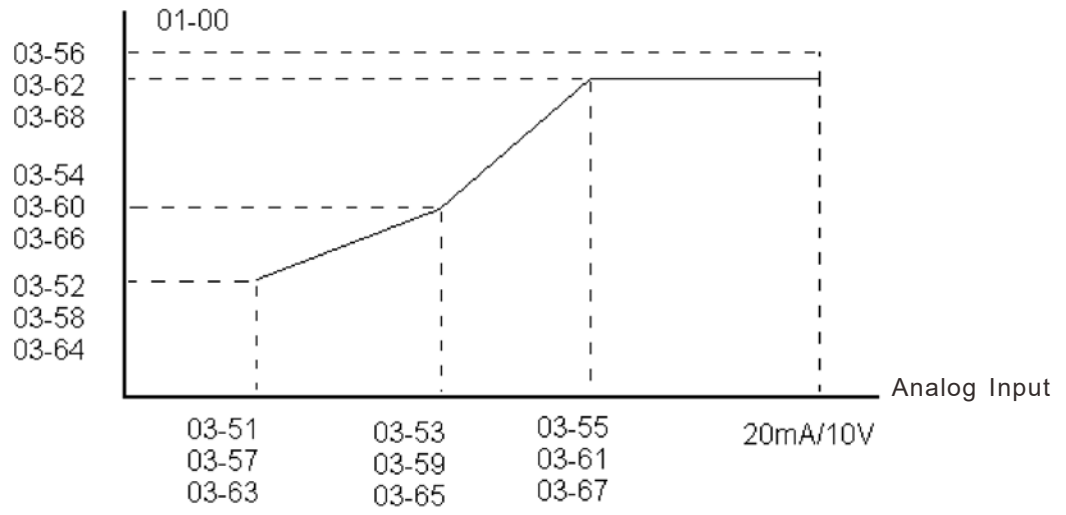



04 Multi-Step Speed Parameters ✎ This parameter can be set during operation.

✎	04-00	1st Step Speed Frequency
✎	04-01	2nd Step Speed Frequency
✎	04-02	3rd Step Speed Frequency
✎	04-03	4th Step Speed Frequency
✎	04-04	5th Step Speed Frequency
✎	04-05	6th Step Speed Frequency
✎	04-06	7th Step Speed Frequency
✎	04-07	8th Step Speed Frequency
✎	04-08	9th Step Speed Frequency
✎	04-09	10th Step Speed Frequency
✎	04-10	11th Step Speed Frequency
✎	04-11	12th Step Speed Frequency
✎	04-12	13th Step Speed Frequency
✎	04-13	14th Step Speed Frequency
✎	04-14	15th Step Speed Frequency

Factory Setting: 0.00

Settings 0.00~599.00Hz

 The Multi-function Input Terminals (refer to setting 1~4 of Pr.02-01~02-08 and 02-26~02-31) are used to select one of the AC motor drive Multi-step speeds (max. 15 speeds). The speeds (frequencies) are determined by Pr.04-00 to 04-14 as shown in the following.

 The run/stop command can be controlled by the external terminal/digital keypad/communication via Pr.00-21.

 Each one of multi-step speeds can be set within 0.00~600.00Hz during operation.

 Explanation of the timing diagram for multi-step speeds and external terminals

The Related parameter settings are:

1. Pr.04-00~04-14: setting multi-step speeds (to set the frequency of each step speed)
2. Pr.02-01~02-08, 02-26~02-31: setting multi-function input terminals (multi-step speed 1~4)

■ Related parameters:

01-22 JOG Frequency

02-01 Multi-function Input Command 1 (MI1)

02-02 Multi-function Input Command 2 (MI2)

02-03 Multi-function Input Command 3 (MI3)

02-04 Multi-function Input Command 4 (MI4)

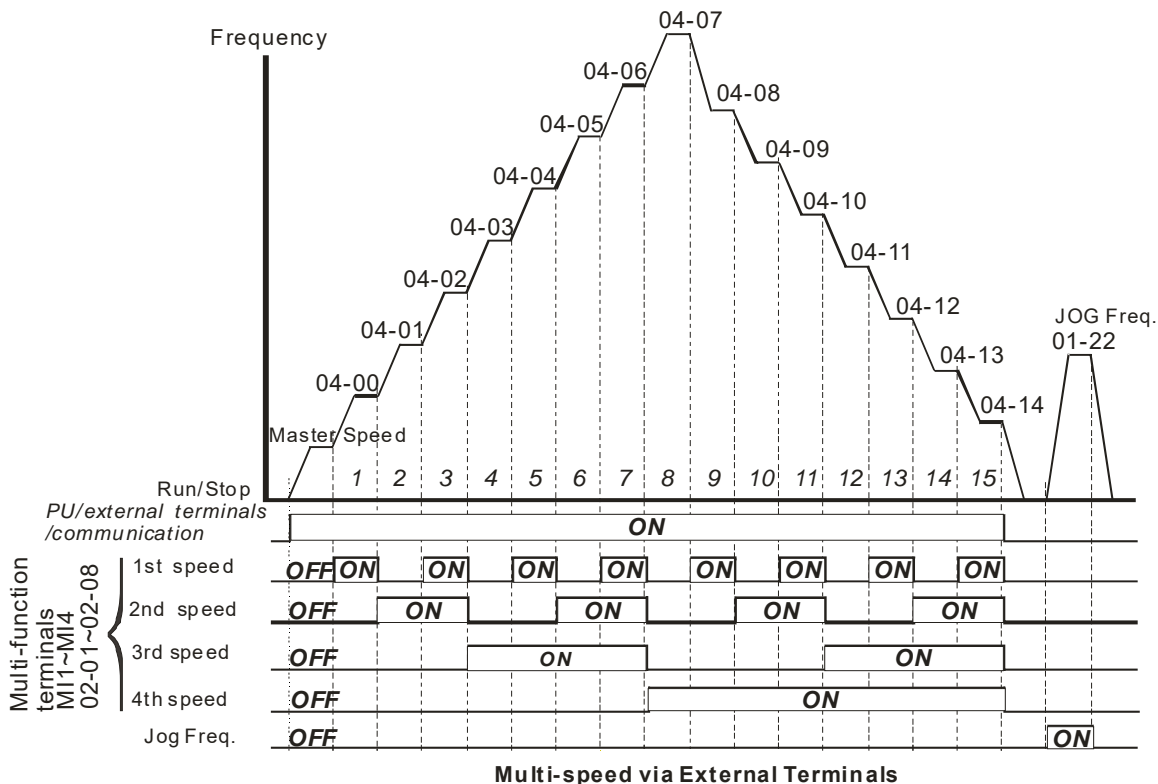

Multi-speed via External Terminals

✎	04-50	PLC Buffer 0
✎	04-51	PLC Buffer 1
✎	04-52	PLC Buffer 2
✎	04-53	PLC Buffer 3
✎	04-54	PLC Buffer 4
✎	04-55	PLC Buffer 5
✎	04-56	PLC Buffer 6
✎	04-57	PLC Buffer 7
✎	04-58	PLC Buffer 8
✎	04-59	PLC Buffer 9
✎	04-60	PLC Buffer 10
✎	04-61	PLC Buffer 11
✎	04-62	PLC Buffer 12
✎	04-63	PLC Buffer 13
✎	04-64	PLC Buffer 14
✎	04-65	PLC Buffer 15
✎	04-66	PLC Buffer 16
✎	04-67	PLC Buffer 17
✎	04-68	PLC Buffer 18
✎	04-69	PLC Buffer 19

Factory Setting: 0

Settings 0~65535

The Pr 04-50~Pr04-69 can be combined with PLC or HMI programming for variety application.

05 Motor Parameters

⚡ This parameter can be set during operation.

05-00 Motor Auto Tuning

Factory Setting: 0

- Settings
- 0: No function
 - 1: Rolling test for induction motor(IM) (Rs, Rr, Lm, Lx, no-load current) [motor running]
 - 2: Static test for induction motor [motor not running]
 - 5: Dynamic test for PM (SPM) motor [motor running]
 - 13: Static test for PM(IPM) motor

Induction Motor

- 📖 This parameter can conduct motor parameters auto test. When setting as 1, motor will roll for more than one round.
- 📖 Press **【Run】** to begin auto tuning when the setting is done. The measured value will be written into motor 1 (Pr.05-05 ~05-09, Rs, Rr, Lm, Lx, no-load current) and motor 2 (Pr.05-17 to Pr.05-21) automatically.

To begin AUTO-Tuning in rolling test:

1. Make sure that all the parameters are set to factory settings (Pr00-02=9 or 10) and the motor wiring is correct.
2. Make sure the motor has no-load before executing auto-tuning and the shaft is not connected to any belt or gear motor. It is recommended to set to 2 if the motor can't separate from the load.
3. Please set motor related parameters according to motor nameplate.

	Motor 1 Parameter	Motor 2 Parameter
Motor Rated Frequency	01-01	01-35
Motor Rated Voltage	01-02	01-36
Motor Full-load Current	05-01	05-13
Motor Rated Power	05-02	05-14
Motor Rated Speed	05-03	05-15
Motor Pole Numbers	05-04	05-16

4. Set Pr.05-00=1 and press **【Run】**, the drive will begin auto-tuning. Please be aware of the motor that it starts spinning as **【Run】** is pressed.
5. When auto-tuning is completed, please check if the measured values are written into motor 1 (Pr.05-05 ~05-09) and motor 2 (Pr.05-17 ~05-21) automatically.
6. Mechanical equivalent circuit

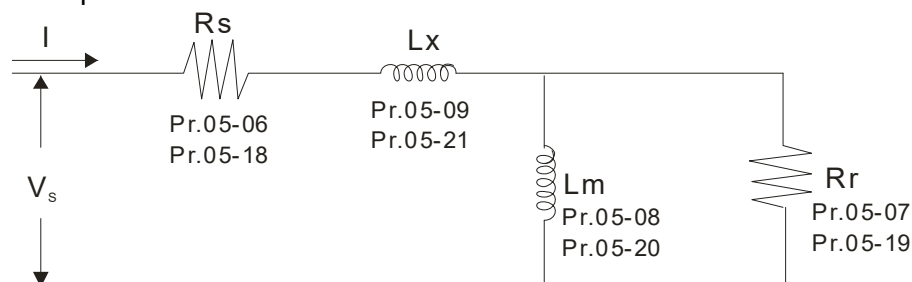

※ If Pr.05-00 is set to 2 (static test), user needs to input the no-load current value of motor into Pr.05-05 for motor 1/Pr.05-17 for motor 2.

 **NOTE**

- ☑ When auto-tuning 2 motors, it needs to set multi-function input terminals (setting 14) or change Pr.05-22 for motor 1/motor 2 selection.
- ☑ The no-load current is usually 20~50% X rated current.
- ☑ The rated speed can not be greater than or equal to $120f/p$ (f = rated frequency Pr.01-01/01-35; P: number of motor poles Pr.05-04/05-16).

05-01 Full-load Current of Induction Motor 1 (A)

Factory Setting:
Determined by motors
power

Settings Determined by motors power

 This value should be set according to the rated current of the motor as indicated on the motor nameplate. The factory setting is 90% X rated current.

Example: The rated current for 7.5HP (5.5kW) is 25 and factory setting is 22.5A. The range for setting will be 2.5~30A. ($25 \times 40\% = 10A$ and $25 \times 120\% = 30A$)

05-02 Rated Power of Induction Motor 1(kW)

Factory Setting: ###

Settings 0~655.35 kW

 It is used to set rated power of the motor 1. The factory setting is the power of the drive.

05-03 Rated Speed of Induction Motor 1 (rpm)

Factory Setting:
1710 (60Hz 4 poles)
1410 (50Hz 4 poles)

Settings 0~65535

 It is used to set the rated speed of the motor according to the motor nameplate.

05-04 Pole Number of Induction Motor 1

Factory Setting: 4

Settings 2~64

 It is used to set the number of motor poles (must be an even number).

 Set up Pr.05-16 after setting up Pr. 01-35 and Pr.05-15 to make sure motor operates normally. IM Motor maximum pole refer to Pr01-01 and Pr05-03.

 For example: when the Pr01-01=20Hz and Pr05-03=39rpm, refer to $120 \times 20\text{Hz} / 39\text{rpm} = 61.5$ (get approximate even value 60); therefore, the maximum setting of Pr05-04 could be 60P.

05-05 No-load Current of Induction Motor 1 (A)

Unit: Ampere
Factory Setting: ###

Settings 0 to the factory setting in Pr.05-01

 The factory setting is 40% motor rated current.

 For model with 110kW and above, default setting is 20% motor rated current.

05-06 Stator Resistance(Rs) of Induction Motor 1

05-07 Rotor Resistance(Rr) of Induction Motor 1

Factory Setting: #.###

Settings 0~65.535Ω

05-08 Magnetizing Inductance(Lm) of Induction Motor 1

05-09 Stator inductance(Lx) of Induction Motor 1

Factory Setting: #.#

Settings 0~6553.5mH

05-13 Full-load Current of Induction Motor 2 (A)

Factory Setting:
Determined by motors
power

Settings Determined by motors power

This value should be set according to the rated frequency of the motor as indicated on the motor nameplate. The factory setting is 90% X rated current.

Example: The rated current for 7.5HP (5.5kW) is 25A and factory setting is 22.5A. The range for setting will be 2.5~30A.(25*40%=10A and 25*120%=30A)

05-14 Rated Power of Induction Motor 2 (kW)

Factory Setting: #.###

Settings 0~655.35 kW

It is used to set rated power of the motor 2. The factory setting is the power of the drive.

05-15 Rated Speed of Induction Motor 2 (rpm)

Factory Setting: 1710

Settings 0~65535
1710 (60Hz 4 poles); 1410 (50Hz 4 poles)

It is used to set the rated speed of the motor according to the motor nameplate.

05-16 Pole Number of Induction Motor 2

Factory Setting: 4

Settings 2~64

It is used to set the number of motor poles (must be an even number).

Set up Pr.05-16 after setting up Pr. 01-35 and Pr.05-15 to make sure motor operates normally. IM Motor maximum pole refer to Pr01-35 and Pr05-15.

For example: when the Pr01-35=20Hz and Pr05-15=39rpm, refer to $120 \times 20\text{Hz} / 39\text{rpm} = 61.5$ (get approximate even value 60); therefore, the maximum setting of Pr05-16 could be 60P.

05-17 No-load Current of Induction Motor 2 (A)

Unit: Ampere
Factory Setting: #.###

Settings 0 to the factory setting in Pr.05-13

The factory setting is 40% motor rated current.

For model with 110kW and above, default setting is 20% motor rated current.

05-18 Stator Resistance (Rs) of Induction Motor 2

05-19 Rotor Resistance (Rr) of Induction Motor 2

Factory Setting: #.###

Settings 0~65.535Ω

05-20 Magnetizing Inductance (Lm) of Induction Motor 2

05-21 Stator Inductance (Lx) of Induction Motor 2

Factory Setting: #.#

Settings 0~6553.5 mH

05-22 Induction Motor 1/ 2 Selection

Factory Setting: 1

Settings 1: Motor 1

2: Motor 2

 It is used to set the motor that driven by the AC motor drive.

05-23 Frequency for Y-connection/ Δ -connection Switch of Induction Motor

Factory Setting: 60.00

Settings 0.00~599.00Hz

05-24 Y-connection/ Δ -connection Switch of Induction Motor IM

Factory Setting: 0

Settings 0: Disable

1: Enable

05-25 Delay Time for Y-connection/ Δ -connection Switch of Induction Motor

Factory Setting: 0.200

Settings 0.000~60.000 sec

 P.05-23 and Pr.05-25 are applied in the wide range motors and the motor coil will execute the switch of Y-connection/ Δ -connection as required. (The wide range motors has relation with the motor design. In general, it has higher torque at low speed and Y-connection and it has higher speed at high speed and connection.

 Pr.05-24 is used to enable/disable Y-connection/ Δ -connection Switch.

 When Pr.05-24 is set to 1, the drive will select by Pr.05-23 setting and current motor frequency to switch motor to Y-connection or Δ -connection. At the same time, it will also affect motor parameters.

 Pr.05-25 is used to set the switch delay time of Y-connection/ Δ -connection.

 When output frequency reaches Y-connection/ Δ -connection switch frequency, drive will delay by Pr.05-25 before multi-function output terminals are active.

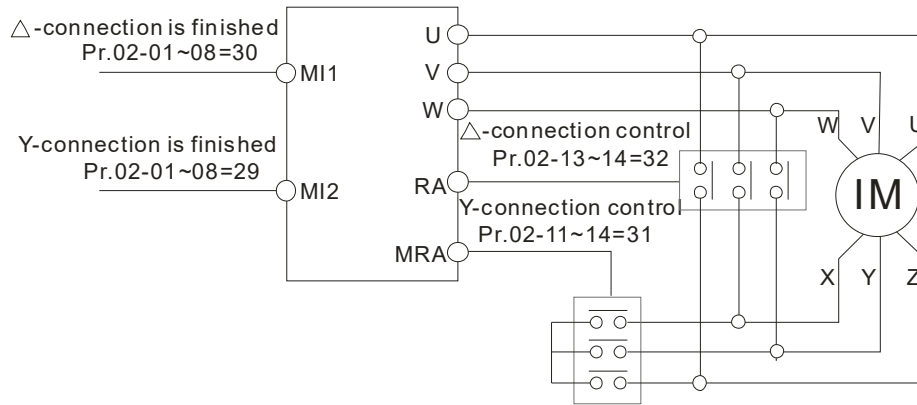

Y-Δ connection switch: can be used for wide range motor
 Y-connection for low speed: higher torque can be used for rigid tapping
 Δ-connection for high speed: higher torque can be used for high-speed drilling

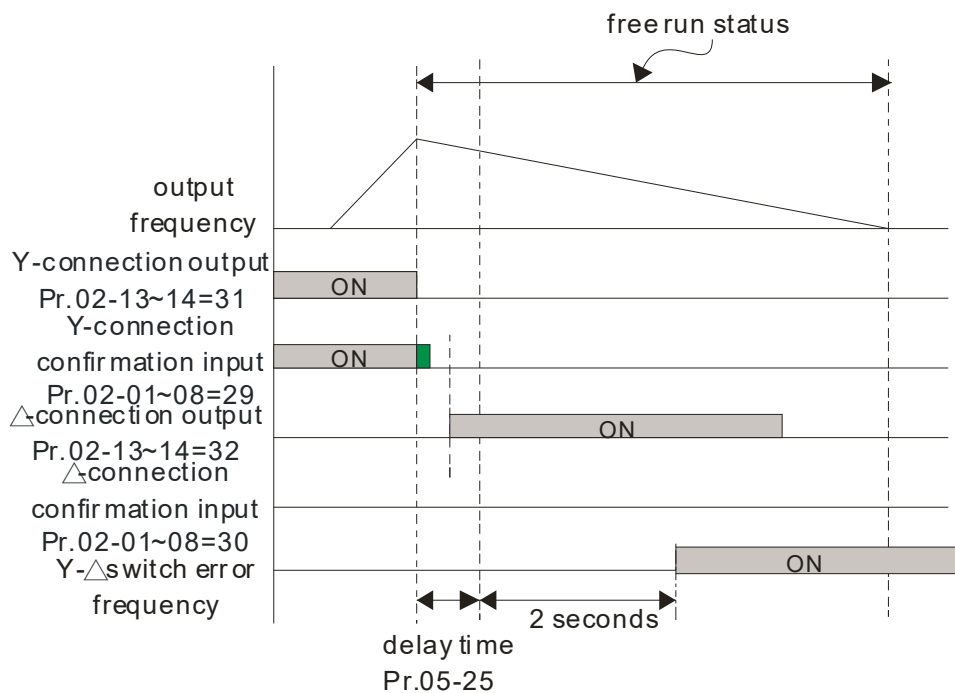
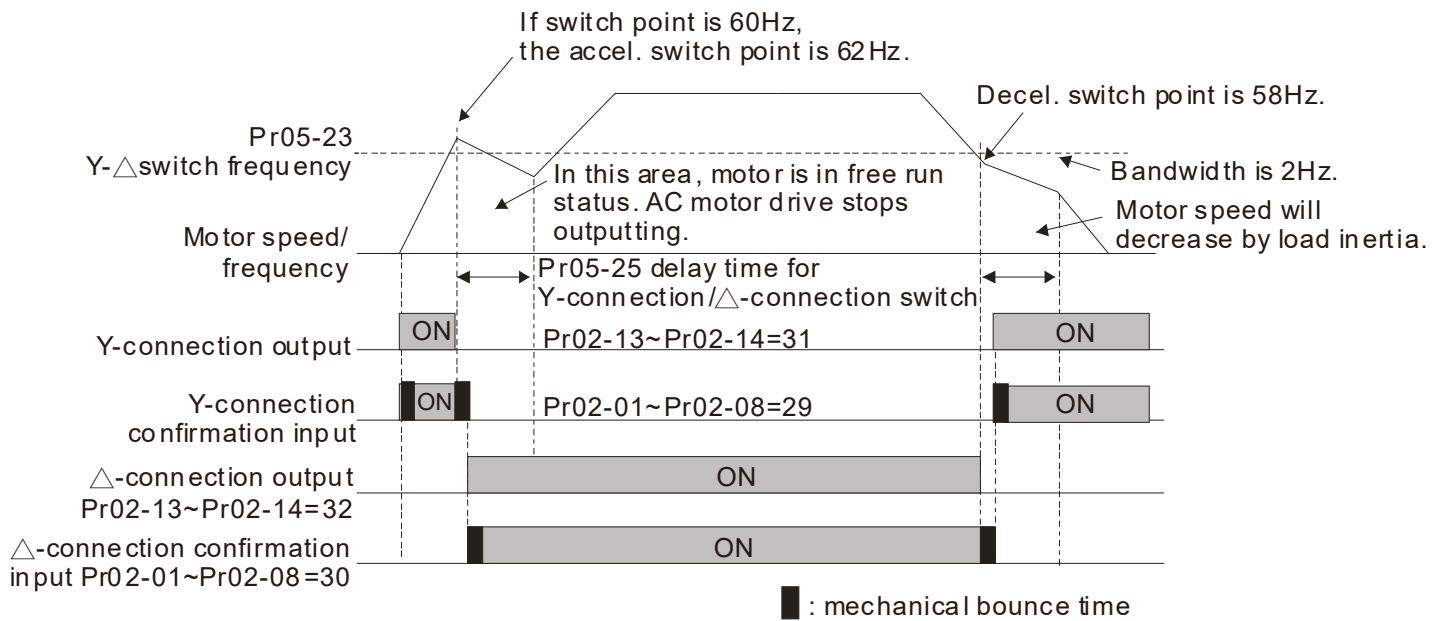

05-28 Motor drive's Accumulated Operating Watt per Hour (W-Hour)

Factory Setting: 0.0

Settings Read only

05-29 Motor drive's Accumulated Operating Kilowatt per Hour (KW-Hour)



Factory Setting: 0.0

Settings Read only

05-30 Motor Drive's Accumulated Operating Megawatt per Hour (MW-Hour)

Factory Setting: 0.0

Settings Read only

-  Pr.05-28~05-29 records the amount of power consumed by motors. The accumulation begins when the drive is activated and record is saved when the drive stops or turns OFF. The amount of consumed watts will continue to accumulate when the drive activate again. To clear the accumulation, set Pr.00-02 to 5 then the accumulation record will return to 0.
-  For example, set Pr.05-28=400Wh, Pr.05-29=150kWh, Pr.05-30=76MWh. The total accumulated power is 76150.4kWh.

05-31 Accumulative Motor Operation Time (Min)

Factory Setting: 0

Settings 00~1439

05-32 Accumulative Motor Operation Time (day)

Factory Setting: 0

Settings 00~65535

-  Pr. 05-31 and Pr.05-32 are used to record the motor operation time. To clear the operation time, set Pr.05-31 and Pr.05-32 to 00. Operation time shorter than 60 seconds will not be recorded.

05-33 Induction Motor (IM) and Permanent Magnet Motor Selection

Factory Setting: 0

Settings 0: Induction Motor
 1: Permanent Magnet Motor (SPM)
 2: Permanent Magnet Motor (IPM)

05-34 Full-load current of Permanent Magnet Motor

Factory Setting:
 Determined by motors
 power

Settings Determined by motors power

-  Set this parameter in accord to motor's nameplate. Default setting is 90% motor drive rated current.
- For example: 7.5HP (5.5kW) rated current is 25A, then Pr05-34 default is 22.5A
- Setting range will be 2.5~30A (25*10%=2.5A 25*120%=30A)

05-35 Rated Power of Permanent Magnet Motor

Factory Setting: Determined by motors power

Settings 0.00~655.35 kW

📖 Set motor rated power in accord to motor nameplate. Default setting is motor drive rated power.

05-36 Rated speed of Permanent Magnet Motor

Factory Setting: 2000

Settings 0~65535 rpm

05-37 Pole number of Permanent Magnet Motor

Factory Setting: 10

Settings 0~65535

05-38 Inertia of Permanent Magnet Motor

Factory Setting: Determined by motors power

Settings 0.0~6553.5 kg.cm² [0.0001kg.m²]

📖 Default value will follow the chart

Rated Power [kW]	0.4	0.75	1.5	2.2	3.7	5.5	7.5	9.3	11
Rotor inertia [kg.cm ²]	1.2	3.0	6.6	15.8	25.7	49.6	82.0	121.6	177.0

Rated Power [kW]	14.1	18.2	27	33	40	46	54	Above 54
Rotor inertia [kg.cm ²]	211.0	265.0	308.0	527.0	866.0	1082.0	1267.6	1515.0

05-39 Stator Resistance of PM Motor

Factory Setting: 0.000

Settings 0.000~65.535Ω

05-40 Permanent Magnet Motor Ld

Factory Setting: 0.00

Settings 0.00~655.35 mH

05-41 Permanent Magnet Motor Lq

Factory Setting: 0.00

Settings 0.00~655.35 mH

05-42 PM Motor Magnetic Angle

Factory Setting: 0.0

Settings 0.0~360.0°

📖 When Pr.05-00 is set to 4, the drive will detect offset angle and write into Pr.05-42.

05-43 Ke parameter of PM Motor

Factory Setting: 0

Settings 0~65535 (Unit: V/1000rpm)

06 Protection Parameters

↗ This parameter can be set during operation.

↗ 06-00 Low Voltage Level

Factory Setting: 360.0

Settings 300.0~440.0VDC

- 📖 This parameter is used to set the Low Voltage level. When the DC BUS voltage is lower than Pr.06-00, drive will stop output and free to stop.
- 📖 If the drive is triggered LV fault during the operation, drive will stop output and free to stop. There are three LV faults, LvA (LV during acceleration), LvD (LV during deceleration), and LvN (LV in constant speed) which will be triggered in different stage of drive operation. These faults need to be reset manually to restart the drive, while setting restart after momentary power off function (Pr.07-06, Pr.07-07), the drive will restart automatically.
- 📖 If LV is triggered when the drive is in stop status, the fault is named LvS (LV during stop), which will not be recorded, and the drive will restart automatically when input voltage is 60VDC (460V series) higher than LV level.

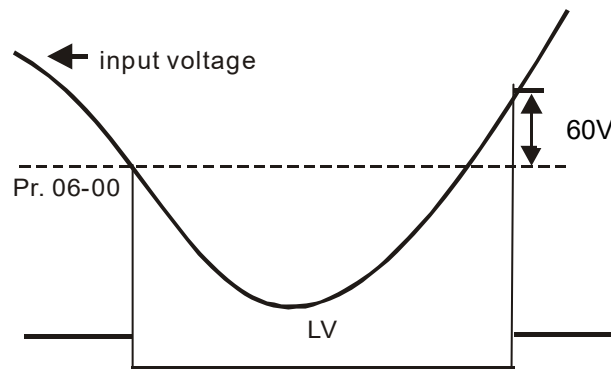

↗ 06-01 Over-voltage Stall Prevention

Factory Setting: 760.0

Settings 0.0~900.0V

0: Disabled

- 📖 When Pr.06-01 is set to 0.0, the over-voltage stall prevention function is disabled. When braking units or resistors are connected to the drive, this setting is suggested.
- 📖 When the setting is not 0.0, the over-voltage stall prevention is activated. This setting should refer to power supply system and loading. If the setting is too low, then over-voltage stall prevention will be easily activate, which may increase deceleration time.
- 📖 Related parameters: Pr.01-13, Pr.01-15, Pr.01-17, Pr.01-19 Decel. Time 1~4, Pr.02-13~Pr.02-15 Multiple-function output (Relay 1, 2 and 3) and Pr.06-02 selection for over-voltage stall prevention.

06-02 Selection for Over-voltage Stall Prevention

Factory Setting: 0

Settings 0: Traditional over-voltage stall prevention

1: Smart over-voltage prevention

- 📖 This function is used for the occasion that the load inertia is unsure. When it stops in the normal

load, the over-voltage won't occur during deceleration and fulfill the setting of deceleration time. Sometimes, it may not stop due to over-voltage during decelerating to stop when increasing the load regenerative inertia. At this moment, the AC drive will auto add the deceleration time until drive stop.

📖 Pr.06-02 is set to 0: During deceleration, the DC bus voltage may exceed its maximum allowable value due to motor regeneration in some situation, such as loading inertia is too high or decel. time is set too short. When traditional over-voltage stall prevention is enabled, the drive will not decelerate further and keep the output frequency constant until the voltage drops below the setting value again.

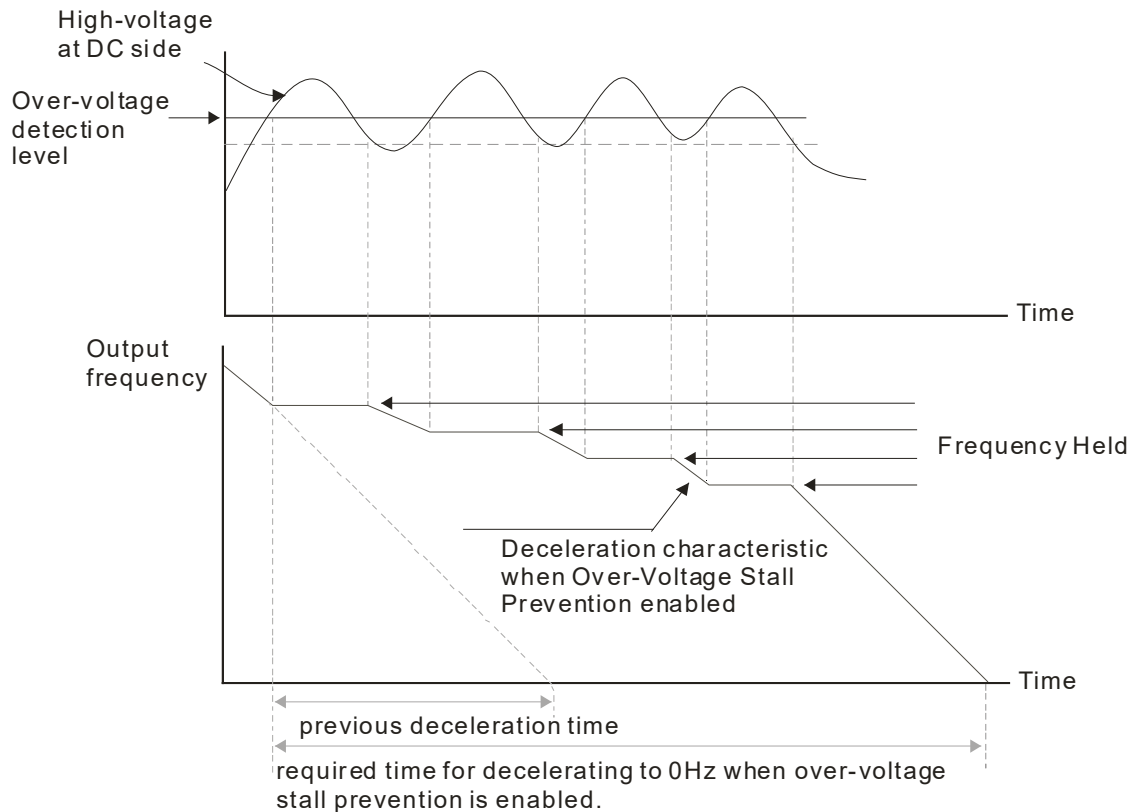

📖 When Pr.06-02 is set to 1, the drive will maintain DCbus voltage when decelerating and prevent OV.

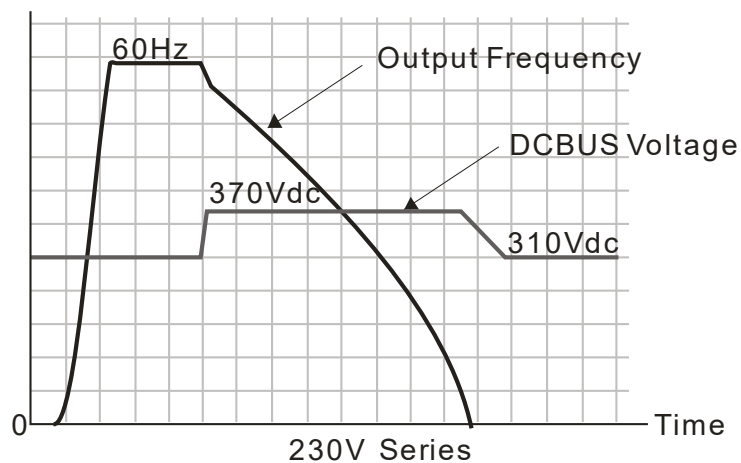

📖 When the over-voltage stall prevention is enabled, drive deceleration time will be larger than the setting.

- 📖 When there is any problem as using deceleration time, refer to the following items to solve it.
 1. Add the suitable deceleration time.
 2. Add brake resistor (refer to Chapter 7-1 for details) to dissipate the electrical energy that regenerated from the motor as heat type.
- 📖 Related parameters: Pr.01-13, Pr.01-15, Pr.01-17, Pr.01-19 Decel. Time 1~4, Pr.02-13~Pr.02-15 Multiple-function output (Relay 1 and 2), Pr.02-16~Pr.02-17 Multiple-function output (MO1,2), and Pr.06-01 over-voltage stall prevention.

🔪 06-03 Over-current Stall Prevention during Acceleration

Factory Setting: 120

Settings Normal duty: 0~160% (100%: drive's rated current)
 Light duty: 0~130% (100%: drive's rated current)

- 📖 This parameter is only valid under VF and SVC mode.
- 📖 If the motor load is too large or drive acceleration time is too short, the AC drive output current may increase abruptly during acceleration and it may cause motor damage or trigger protection functions (OL or OC). This parameter is used to prevent this situation.
- 📖 During acceleration, the AC drive output current may increase abruptly and exceed the value specified by Pr.06-03 due to rapid acceleration or excessive load on the motor. When this function is enabled, the AC drive will stop accelerating and keep the output frequency constant until the current drops below the maximum value.
- 📖 When the over-current stall prevention is enabled, drive acceleration time will be larger than the setting.
- 📖 When the Over-Current Stall Prevention occurs due to too small motor capacity or in the factory setting, please decrease Pr.06-03 setting.
- 📖 When there is any problem by using acceleration time, refer to the following items to solve it.
- 📖 Related parameters: Pr.01-12, 01-14, 01-16, 01-18 (settings of accel. time 1~4), Pr.01-44
 1. Add suitable acceleration time.
 2. Setting Pr.01-44 Optimal Acceleration/Deceleration Setting to 1, 3 or 4 (auto accel.)
 3. Optimal Acceleration/Deceleration Setting, Pr.02-13~02-15 (Multi-function Output 1 RY1, RY2, RY3).

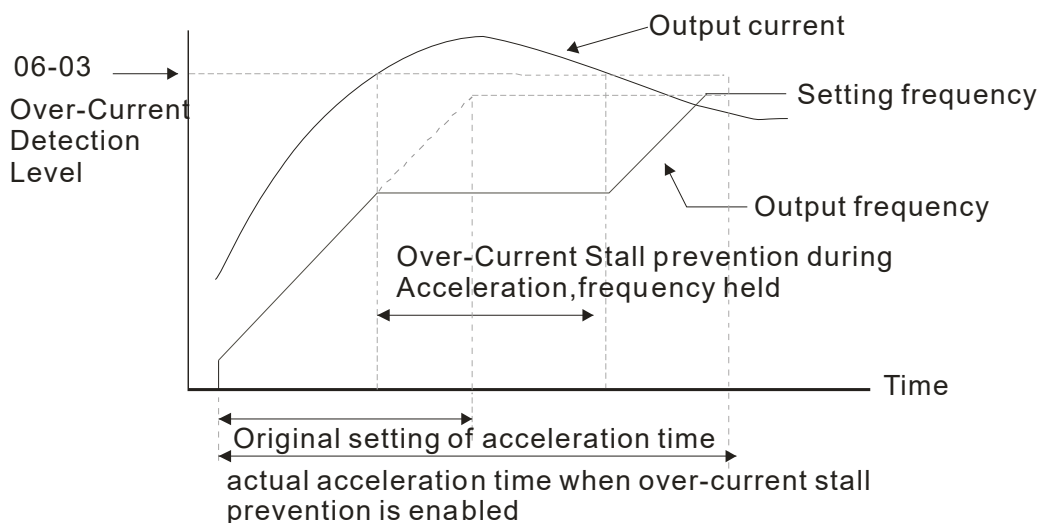

➤ **06-04** Over-current Stall Prevention during Operation

Factory Setting: 120

Settings Normal duty: 0~160% (100%: drive's rated current)
 Light duty: 0~130% (100%: drive's rated current)

- 📖 It is a protection for drive to auto decrease output frequency when the motor is over-load abruptly during motor constant operation.
- 📖 If the output current exceeds the setting specified in Pr.06-04 when the drive is operating, the drive will decrease its output frequency (according to Pr.06-05) to prevent the motor stall. If the output current is lower than the setting specified in Pr.06-04, the drive will accelerate (according to Pr.06-05) again to catch up with the set frequency command value.

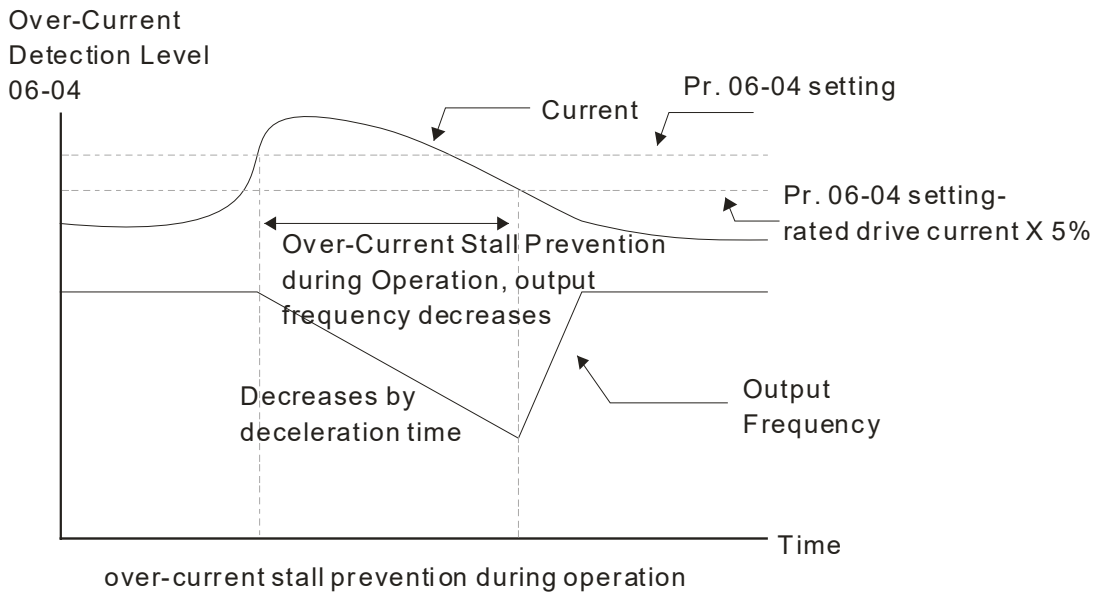

➤ **06-05** Accel./Decel. Time Selection of Stall Prevention at Constant Speed

Factory Setting: 0

Settings 0: by current accel/decel time
 1: by the 1st accel/decel time
 2: by the 2nd accel/decel time
 3: by the 3rd accel/decel time
 4: by the 4th accel/decel time
 5: by auto accel/decel

- 📖 It is used to set the accel./decel. time selection when stall prevention occurs at constant speed.

➤ **06-06** Over-torque Detection Selection (OT1)

Factory Setting: 0

Settings 0: No function
 1: Continue operation after Over-torque detection during constant speed operation
 2: Stop after Over-torque detection during constant speed operation
 3: Continue operation after Over-torque detection during RUN
 4: Stop after Over-torque detection during RUN

➤ **06-09** Over-torque Detection Selection (OT2)

Factory Setting: 0

- Settings
- 0: No function
 - 1: Continue operation after Over-torque detection during constant speed operation
 - 2: Stop after Over-torque detection during constant speed operation
 - 3: Continue operation after Over-torque detection during RUN
 - 4: Stop after Over-torque detection during RUN

📖 When Pr.06-06 and Pr.06-09 are set to 1 or 3, it will display a warning message and won't have an abnormal record.

📖 When Pr.06-06 and Pr.06-09 are set to 2 or 4, it will display a warning message and will have an abnormal record.

➤ **06-07** Over-torque Detection Level (OT1)

Factory Setting: 120

- Settings 10 to 200% (100%: drive's rated current)

➤ **06-08** Over-torque Detection Level (OT1)

Factory Setting: 0.1

- Settings 0.0~60.0 sec

➤ **06-10** Over-torque Detection Level (OT2)

Factory Setting: 120

- Settings 10 to 200% (100%: drive's rated current)

➤ **06-11** Over-torque Detection Time (OT2)

Factory Setting: 0.1

- Settings 0.0~60.0 sec

📖 When the output current exceeds the over-torque detection level (Pr.06-07 or Pr.06-10) and also exceeds Pr.06-08 or Pr.06-11, the over torque detection will follow the setting of Pr.06-06 and Pr.06-09.

📖 When Pr.06-06 or Pr.06-09 is set to 1 or 3, the motor drive will have the ot1/ot2 warning after Over Torque Detection, while the motor drive will keep running. The warning will be off only until the output current is smaller than the 5% of the over-torque detection level (Pr.06-07 and Pr.06-10).

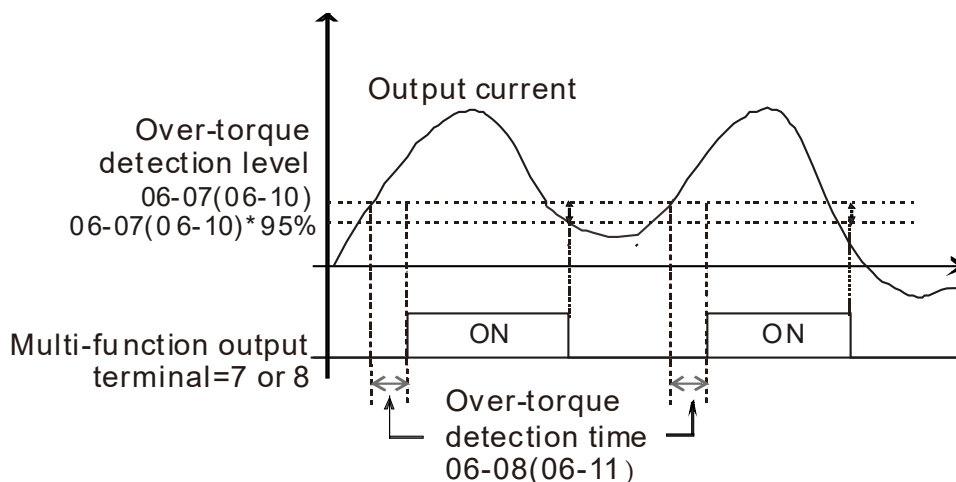

When Pr.06-06 or Pr.06-09 is set to 2 or 4, the motor drive will have the ot1/ot2 fault after Over Torque Detection. Then the motor drive stop running until it is manually reset.

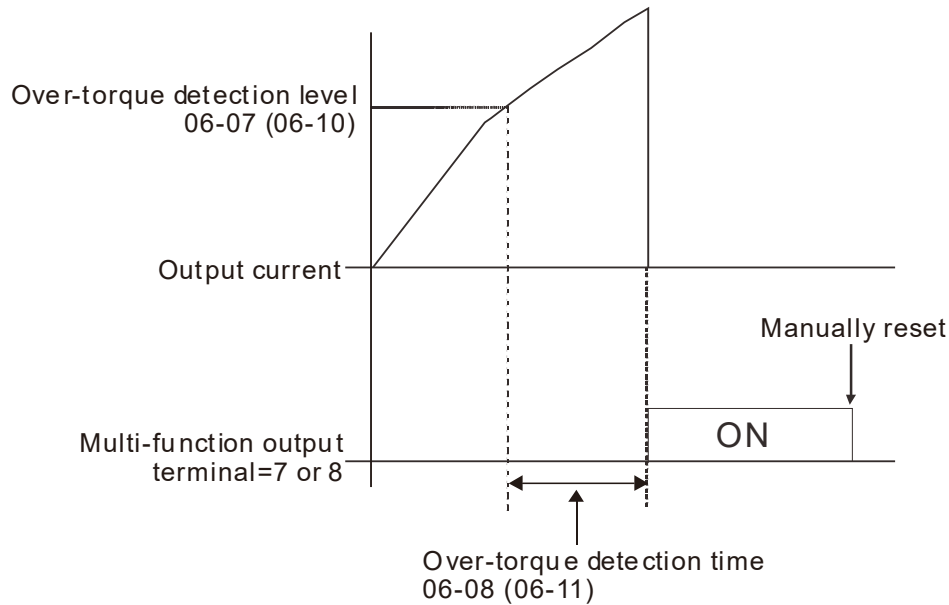

➤ **06-12** Current Limit

Factory Setting: 150

Settings 0~200% (100%: drive's rated current)

Pr.06-12 sets the maximum output current of the drive. When it is under VF, SVC control mode, and the output current of the driver exceeds to this current limit, the output frequency will reduce automatically as an over-current stall prevention.

➤ **06-13** Electronic Thermal Relay Selection (Motor 1)

➤ **06-27** Electronic Thermal Relay Selection (Motor 2)

Factory Setting: 2

Settings 0: Inverter motor (with external forced cooling)

1: Standard motor (so motor with fan on the shaft)

2: Disable

It is used to prevent self-cooled motor overheats under low speed. User can use electronic thermal relay to limit driver's output power.

Setting as 0 is suitable for special motor (motor fan using independent power supply). For this kind of motor, the cooling capacity is not related to motor speed obviously. So the action of electronic thermal relay will remain stable in low speed, which can ensure the motor's load capability in low speed.

Setting as 1 is suitable for standard motor (motor fan is fixed on the rotor shaft). For this kind of motor, the cooling capacity is low in low speed, and the action of electronic thermal relay will reduce the action time, which ensure the life of motor.

When the power ON/OFF is often switched, even setting as 0 or 1 can not protect the motor well. It is because when the power is switched off, the electronic thermal relay protection will be reset. If there are several motors connected to one motor drive, please install electronic thermal relay in each motor respectively.

↗ **06-14** Electronic Thermal Characteristic for Motor 1

↗ **06-28** Electronic Thermal Characteristic for Motor 2

Factory Setting: 60.0

Settings 30.0~600.0 sec

📖 The parameter is set by the 150% of motor rated current and the setting of Pr.06-14 and Pr.06-28 to prevent the motor damaged from overheating. When it reaches the setting, it will display “EoL1/EoL2” and the motor will be in free running.

📖 This parameter is to set the action time of electronic thermal relay. It works based on the I2t characteristic curve of electronic thermal relay, output frequency and current of motor drive, and operation time to prevent motor from over-heat.

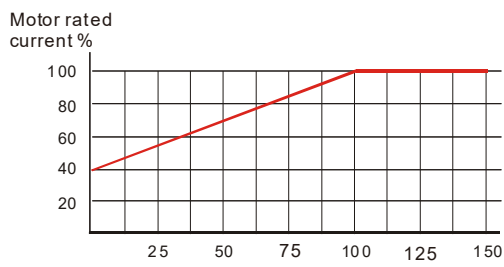

Motor cooling curve with shaft-fixed fan

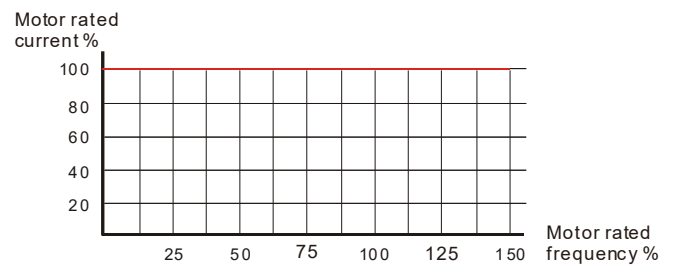

Motor cooling curve with independent fan

📖 The action of electronic thermal relay depends on the setting of Pr.06-13/Pr.06-27.

1. 06-13 or 06-27 is set 0 (using special motor) :

When output current of motor drive is higher than 150% of motor current (refer to motor cooling curve with independent fan), motor drive will start to count the time. When the accumulated time exceeds Pr.06-14 or 06-28, electronic thermal relay will act.

2. 06-13 or 06-27 is set 0 (using standard motor) :

When output current of motor drive is higher than 150% of motor current (refer to motor cooling curve with shaft-fixed fan), motor drive will start to count the time. When the accumulated time exceeds Pr.06-14 or 06-28, electronic thermal relay will act.

The real electronic thermal relay action time will adjust with drive output current (shown as motor loading rate). When the current is high, the action time is short; when the current is high, the action time is short. Please refer to following chart:

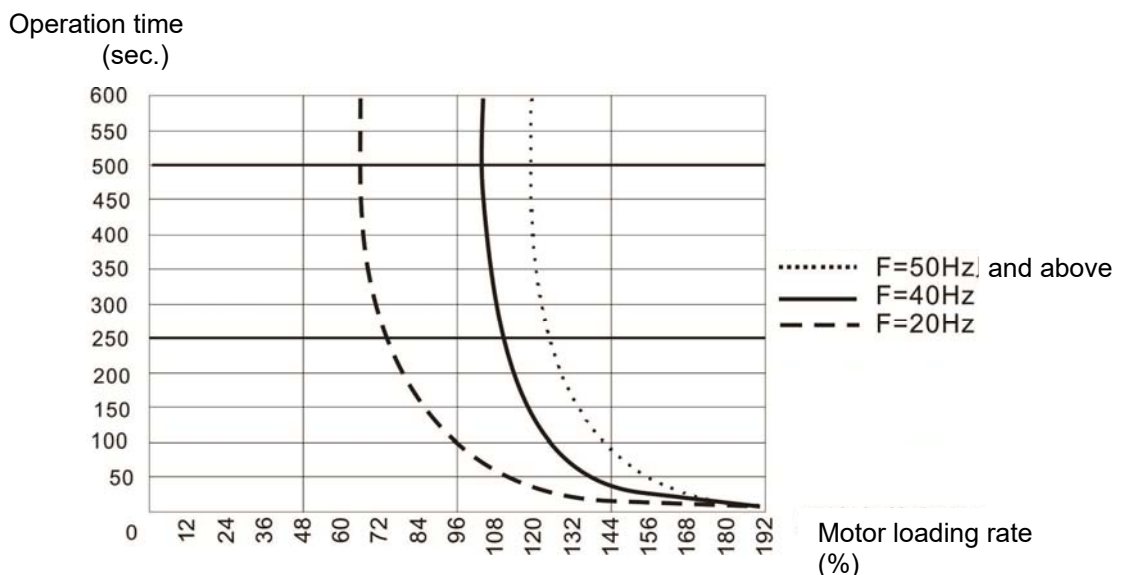

➤ **06-15** Heat Sink Over-heat (OH1) Warning

Factory Setting: 105.0

Settings 0.0~110.0°C (see below table listed)

📖 OH1 Warning:

Frame	Model	OH1	OH Warning
A	VFD007FP4EA-52/52S/41	110	OH1 Warning= OH1-5
	VFD015FP4EA-52/52S/41	110	
	VFD022FP4EA-52/52S/41	100	
	VFD037FP4EA-52/52S/41	100	
	VFD040FP4EA-52/52S/41	100	
	VFD055FP4EA-52/52S/41	100	
	VFD075FP4EA-52/52S/41	100	
B	VFD110FP4EA-52/52S/41	105	
	VFD150FP4EA-52/52S/41	105	
	VFD185FP4EA-52/52S/41	105	
	VFD220FP4EA-52/52S/41	105	
C	VFD300FP4EA-52/52S/41	110	
	VFD370FP4EA-52/52S/41	110	
D0	VFD450FP4EA-52/52S/41	100	
	VFD550FP4EA-52/52S/41	100	
D	VFD750FP4EA-52/52S/41	95	
	VFD900FP4EA-52/52S/41	95	

For example, when Pr.06-15=100, the OH1 error is 100°C, then the OH1 Warning will be activated at 100-5=95°C.

- 📖 When using heavy duty or advanced control mode, the OH warning will be disabled if Pr.06-15 remains as default. When the temperature reaches 100°C, motor drive will stop with IGBT over-heat fault.
- 📖 When using normal duty or general control mode, the OH warning will be disabled if Pr.06-15 is set to 110°C. When the temperature reaches 110°C, motor drive will stop with IGBT over-heat fault.
- 📖 When IGBT temperature is above setting value minus 15°C, the cooling fan will enhance performance to 100%; otherwise, when IGBT temperature is below 35°C of setting value and the temperature of CAP is below 10°C of OH2 over-heat warning, the cooling fan will reset. 35°C will be the criterion if parameter setting is below 35°C.

➤ **06-16** Stall Prevention Limit Level (Flux weakening area current stall prevention level)

Factory Setting: 50

Settings 0~100% (Refer to Pr.06-03, Pr.06-04)



- 📖 When operation frequency is larger than Pr.01-01; e.g. Pr.06-03=150%, Pr.06-04=100% and Pr.06-16=80%:
 Calculate the Stall Prevention Level during acceleration: Pr.06-03 * Pr.06-16=150x80%=120%.
 Calculate the Stall Prevention Level at constant speed: Pr.06-04 * Pr.06-16=100x80%=80%.

06-17	Fault Record 1 (Present Fault Record)
06-18	Fault Record 2
06-19	Fault Record 3
06-20	Fault Record 4
06-21	Fault Record 5
06-22	Fault Record 6

Settings

- 0: No fault record
- 1: Over-current during acceleration (ocA)
- 2: Over-current during deceleration (ocd)
- 3: Over-current during constant speed(ocn)
- 4: Ground fault (GFF)
- 5: IGBT short-circuit (occ)
- 6: Over-current at stop (ocS)
- 7: Over-voltage during acceleration (ovA)
- 8: Over-voltage during deceleration (ovd)
- 9: Over-voltage during constant speed (ovn)
- 10: Over-voltage at stop (ovS)
- 11: Low-voltage during acceleration (LvA)
- 12: Low-voltage during deceleration (Lvd)
- 13: Low-voltage during constant speed (Lvn)
- 14: Stop mid-low voltage (LvS)
- 15: Phase loss protection (OrP)
- 16: IGBT over-heat (oH1)
- 17: Capacitance over-heat (oH2) (for 40hp above)
- 18: tH1o (TH1 open: IGBT over-heat protection error)
- 19: tH2o (TH2 open: capacitance over-heat protection error)
- 21: Drive over-load (oL)
- 22: Electronics thermal relay 1 (EoL1)
- 23: Electronics thermal relay 2 (EoL2)
- 24: Motor PTC overheat (oH3) (PTC/PT100)
- 26: Over-torque 1 (ot1)
- 27: Over-torque 2 (ot2)
- 28: Low current (uC)
- 30: Memory write-in error (cF1)
- 31: Memory read-out error (cF2)
- 33: U-phase current detection error (cd1)
- 34: V-phase current detection error (cd2)
- 35: W-phase current detection error (cd3)
- 36: Clamp current detection error (Hd0)
- 37: Over-current detection error (Hd1)
- 38: Over-voltage detection error (Hd2)
- 39: occ IGBT short circuit detection error (Hd3)
- 40: Auto tuning error (AUE)
- 41: PID feedback loss (AFE)
- 48: Analog current input loss (ACE)
- 49: External fault input (EF)
- 50: Emergency stop (EF1)
- 51: External Base Block (bb)
- 52: Password error (Pcod)
- 53: Firmware code error
- 54: Communication error (CE1)
- 55: Communication error (CE2)
- 56: Communication error (CE3)

- 57: Communication error (CE4)
- 58: Communication Time-out (CE10)
- 60: Brake transistor error (bF)
- 61: Y-connection/ Δ -connection switch error (ydc)
- 62: Decel. Energy Backup Error (dEb)
- 63: Slip error (oSL)
- 64: Electromagnet switch error (ryF)
- 72: Channel 1 (STO1~SCM1) internal hardware error (STL1)
- 73: External safety gate S1
- 74: FIRE mode output
- 76: Safety Torque Off (STO)
- 77: Channel 2 (STO2~SCM2) internal hardware error (STL2)
- 78: Channel 1 and Channel 2 internal hardware error (STL3)
- 79: U PHASE SHORT (Uocc)
- 80: V PHASE SHORT (Vocc)
- 81: W PHASE SHORT (Wocc)
- 82: OPHL U phase output phase loss
- 83: OPHL Vphase output phase loss
- 84: OPHL Wphase output phase loss
- 90: Inner PLC function is forced to stop
- 99: TRAP CPU command error
- 101: CGdE CANopen software disconnect1
- 102: ChbE CANopen software disconnect2
- 103: CsyE CANopen synchronous error
- 104: CbFE CANopen hardware disconnect
- 105: CidE CANopen index setting error
- 106: CadE CANopen slave station number setting error
- 107: CfrE CANopen index setting exceed limit
- 111: InrCOM Internal communication overtime error

-  When the fault occurs and force stopping, it will record in this parameter.
-  At stop with low voltage Lv (LvS warn, no record). During operation with mid-low voltage Lv (LvA, Lvd, Lvn error, will record).
-  Setting 62: when dEb function is enabled, the drive will execute dEb and record to the Pr.06-17 to Pr.06-22 simultaneously.

✎	06-23	Fault Output Option 1
✎	06-24	Fault Output Option 2
✎	06-25	Fault Output Option 3
✎	06-26	Fault Output Option 4

Factory Setting: 0

Settings 0~65535 sec (refer to bit table for fault code)

-  These parameters can be used with multi-function output (set to 35-38) for the specific requirement. When the fault occurs, the corresponding terminals will be activated (It needs to convert binary value to decimal value to fill in Pr.06-23 to Pr.06-26).

Fault Code	Bit0	Bit1	Bit2	Bit3	Bit4	Bit5	Bit6
	current	Volt.	OL	SYS	FBK	EXI	CE
0: No fault							
1: Over-current during acceleration (ocA)	●						
2: Over-current during deceleration (ocd)	●						
3: Over-current during constant speed(ocn)	●						

Fault Code	Bit0	Bit1	Bit2	Bit3	Bit4	Bit5	Bit6
	current	Volt.	OL	SYS	FBK	EXI	CE
4: Ground fault (GFF)	●						
5: IGBT short-circuit (occ)	●						
6: Over-current at stop (ocS)	●						
7: Over-voltage during acceleration (ovA)		●					
8: Over-voltage during deceleration (ovd)		●					
9: Over-voltage during constant speed (ovn)		●					
10: Over-voltage at stop (ovS)		●					
11: Low-voltage during acceleration (LvA)		●					
12: Low-voltage during deceleration (Lvd)		●					
13: Low-voltage during constant speed (Lvn)		●					
14: Stop mid-low voltage (LvS)		●					
15: Phase loss protection (OrP)		●					
16: IGBT over-heat (oH1)			●				
17: Capacitance over-heat (oH2)			●				
18: tH1o (TH1 open)			●				
19: tH2o (TH2 open)			●				
21: Drive over-load (oL)			●				
22: Electronics thermal relay 1 (EoL1)			●				
23: Electronics thermal relay 2 (EoL2)			●				
24: Motor PTC overheat (oH3) (PTC)			●				
26: Over-torque 1 (ot1)			●				
27: Over-torque 2 (ot2)			●				
28: Low current (uC)	●						
30: Memory write-in error (cF1)				●			
31: Memory read-out error (cF2)				●			
33: U-phase current detection error (cd1)				●			
34: V-phase current detection error (cd2)				●			
35: W-phase current detection error (cd3)				●			
36: Clamp current detection error (Hd0)				●			
37: Over-current detection error (Hd1)				●			
38: Over-voltage detection error (Hd2)				●			
39: occ IGBT short circuit detection error (Hd3)				●			
40: Auto tuning error (AUE)				●			
41: PID feedback loss (AFE)					●		
48: Analog current input loss (ACE)					●		
49: External fault input (EF)						●	
50: Emergency stop (EF1)						●	
51: External Base Block (bb)						●	
52: Password error (Pcod)				●			
53: Software code error				●			
54: Communication error (CE1)							●
55: Communication error (CE2)							●
56: Communication error (CE3)							●
57: Communication error (CE4)							●
58: Communication Time-out (CE10)							●
60: Brake transistor error (bF)						●	

Fault Code	Bit0	Bit1	Bit2	Bit3	Bit4	Bit5	Bit6
	current	Volt.	OL	SYS	FBK	EXI	CE
61: Y-connection/ Δ -connection switch error (ydc)						●	
62: Decel. Energy Backup Error (dEb)		●					
63: Slip error (oSL)						●	
64: Electromagnet switch error (ryF)						●	
72: Channel 1 (STO1~SCM1) internal hardware error (STL1)						●	
73: External safety gate S1				●			
74: FIRE mode output						●	
76: Safety Torque Off (STO)						●	
77: Channel 2 (STO2~SCM2) internal hardware error (STL2)						●	
78: Channel 1 and Channel 2 internal hardware error (STL3)						●	
79: U phase over current (Uocc)	●						
80: V phase over current (Vocc)	●						
81: W phase over current (Wocc)	●						
82: OPHL U phase output phase loss	●						
83: OPHL Vphase output phase loss	●						
84: OPHL Wphase output phase loss	●						
90: Inner PLC function is forced to stop				●			
99: TRAP CPU command error				●			
101: CgdE CANopen software disconnect1							●
102: ChbE CANopen software disconnect2							●
103: CsyE CANopen synchronous error							●
104: CbFE CANopen hardware disconnect							●
105: CidE CANopen index setting error							●
106: CadE CANopen slave station number setting error							●
107: CfrE CANopen index setting exceed limit							●
111: InrCOM Internal communication overtime error							●

06-29 PTC (Positive Temperature Coefficient) Detection Selection

Factory Setting: 0

- Settings
- 0: Warn and keep operating
 - 1: Warn and ramp to stop
 - 2: Warn and coast to stop
 - 3: No warning

 Pr.06-29 setting defines how the will drive operate after PTC detection.

06-30 PTC Level

Factory Setting: 50.0

Settings 0.0~100.0%

 It needs to set AVI1/ACI/AVI2 analog input function Pr.03-00~03-02 to 6 (P.T.C. thermistor input value).

 It is used to set the PTC level, and the corresponding value for 100% is max. analog input value.

06-31 Frequency Command for Malfunction

Factory Setting: Read only

Settings 0.00~599.00Hz

 When malfunction occurs, user can check the frequency command. If it happens again, it will overwrite the previous record.

06-32 Output Frequency at Malfunction

Factory Setting: Read only

Settings 0.00~599.00Hz

 When malfunction occurs, user can check the current frequency command. If it happens again, it will overwrite the previous record.

06-33 Output Voltage at Malfunction

Factory Setting: Read only

Settings 0.0~6553.5V

 When malfunction occurs, user can check current output voltage. If it happens again, it will overwrite the previous record.

06-34 DC Voltage at Malfunction

Factory Setting: Read only

Settings 0.0~6553.5V

 When malfunction occurs, user can check the current DC voltage. If it happens again, it will overwrite the previous record.

06-35 Output Current at Malfunction

Factory Setting: Read only

Settings 0.0~6553.5Amp

 When malfunction occurs, user can check the current output current. If it happens again, it will overwrite the previous record.

06-36 IGBT Temperature at Malfunction

Factory Setting: Read only

Settings -3276.7~3276.7°C

 When malfunction occurs, user can check the current IGBT temperature. If it happens again, it will overwrite the previous record.

06-37 Capacitance Temperature at Malfunction

Factory Setting: Read only

Settings -3276.7~3276.7°C

 When malfunction occurs, user can check the current capacitance temperature. If it happens again, it will overwrite the previous record.

06-38 Motor Speed in rpm at Malfunction

Factory Setting: Read only

Settings -32767~32767 rpm

📖 When malfunction occurs, user can check the current motor speed in rpm. If it happens again, it will overwrite the previous record.

06-40 Status of Multi-function Input Terminal at Malfunction

Factory Setting: Read only

Settings 0000h~FFFFh

06-41 Status of Multi-function Output Terminal at Malfunction

Factory Setting: Read only

Settings 0000h~FFFFh

📖 When malfunction occurs, user can check the status of multi-function input/output terminals. If it happens again, it will overwrite the previous record.

06-42 Drive Status at Malfunction

Factory Setting: Read only

Settings 0000H~FFFFh

📖 When malfunction occurs, please check the drive status (communication address 2119H). If malfunction happens again, the previous record will be overwritten by this parameter.

↗ **06-44** STO Alarm Latch

Factory Setting: 0

Settings 0: STO alarm Latch
1: STO alarm no Latch

- 📖 Pr.06-44=0 STO Alarm Latch: after the reason of STO Alarm is cleared, a Reset command is needed to clear STO Alarm.
- 📖 Pr.06-44=1 STO Alarm no Latch: after the reason of STO Alarm is cleared, the STO Alarm will be cleared automatically.
- 📖 All of STL1~STL3 error are "Alarm latch" mode (in STL1~STL3 mode, the Pr.06-44 function is no effective).

↗ **06-45** Treatment to Output Phase Loss (OPHL)

Factory Setting: 3

Settings 0: Warn and keep operating
1: Warn and ramp to stop
2: Warn and coast to stop
3: No warning

📖 The OPHL protect will be active when the setting is not 3.

↗ **06-46** Deceleration Time of Output Phase Loss

Factory Setting: 0.500

Settings 0.000~65.535 sec

↗ **06-47** Current detection level of output phase loss
 Factory Setting:1.00
 Settings 0.00~100.00%

↗ **06-48** Output phase loss detection function executing time before run
 Factory Setting:0.000
 Settings 0.000~65.535 sec

📖 When Pr.06-48 is 0, OPHL detection function will be disabled

📖 Status 1 : Motor drive is in operation

Any phase is less than Pr.06-47 setting level, and exceeds Pr.06-46 setting time, motor drive will perform Pr.06-45 setting.

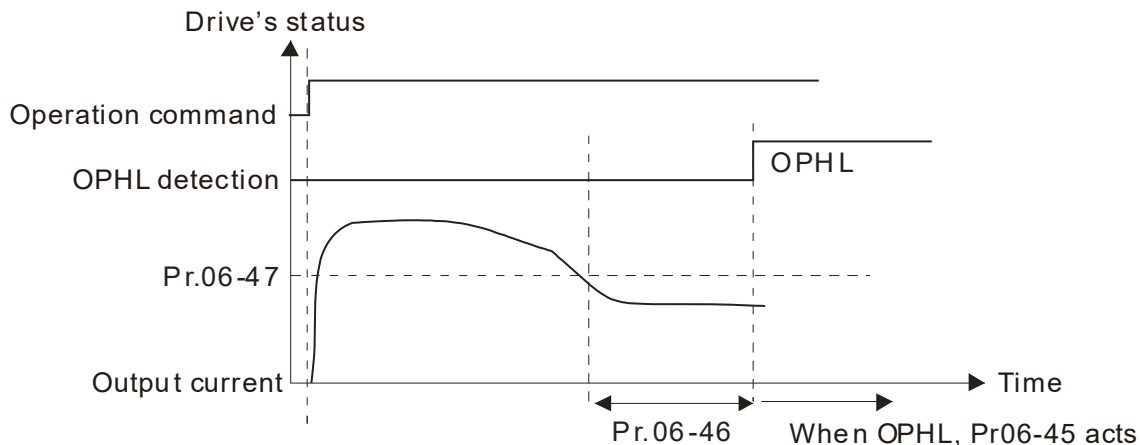

📖 Status 2 : Motor drive is in stop; Pr.06-48=0 ; Pr.07-02 ≠ 0

After motor drive starts, DC brake will be applied in accord to Pr.07-01 and Pr.07-02. During this period, OPHL detection will not be conducted. After DC brake, motor drive starts to run, and conducts the OPHL protection as mentioned in status 1.

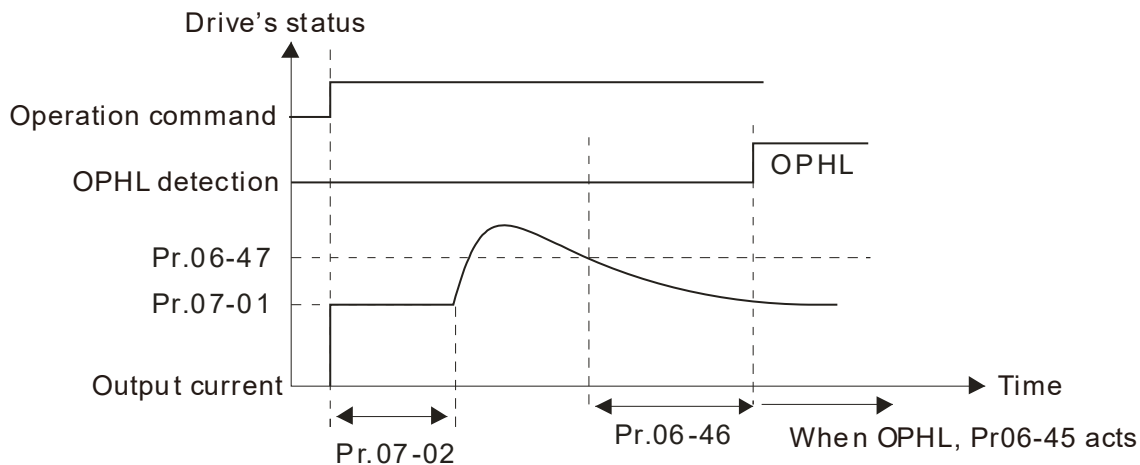

📖 Status 3: Motor drive is in stop; Pr.06-48 ≠ 0 ; Pr.07-02 ≠ 0

When motor drive starts, it will perform Pr.06-48 and then Pr.07-02 (DC brake). DC brake current level in this status includes two parts, one is 20 times of Pr.06-47 setting value in Pr.06-48 setting time, and Pr.07-02 setting value in Pr.07-01 setting time. Total DC brake time is $T=Pr.06-48+Pr.07-02$.

In this period, if OPHL happens, motor drive starts to count Pr.06-48/2 time, motor drive will perform Pr.06-45 setting.

Status 3-1: Pr06-48 ≠ 0, Pr07-02 ≠ 0 (No OPHL detected before operation)

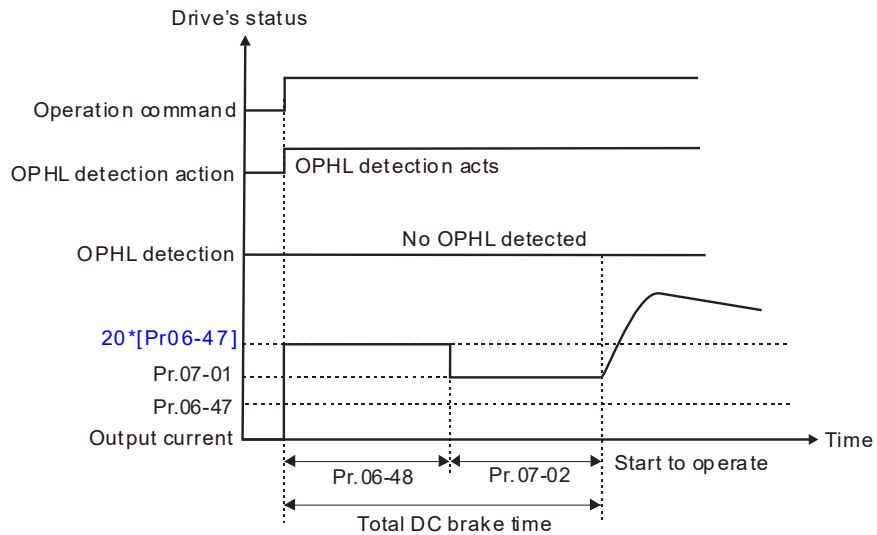

Status 3-2: Pr06-48 ≠ 0, Pr07-02 ≠ 0 (OPHL detected before operation)

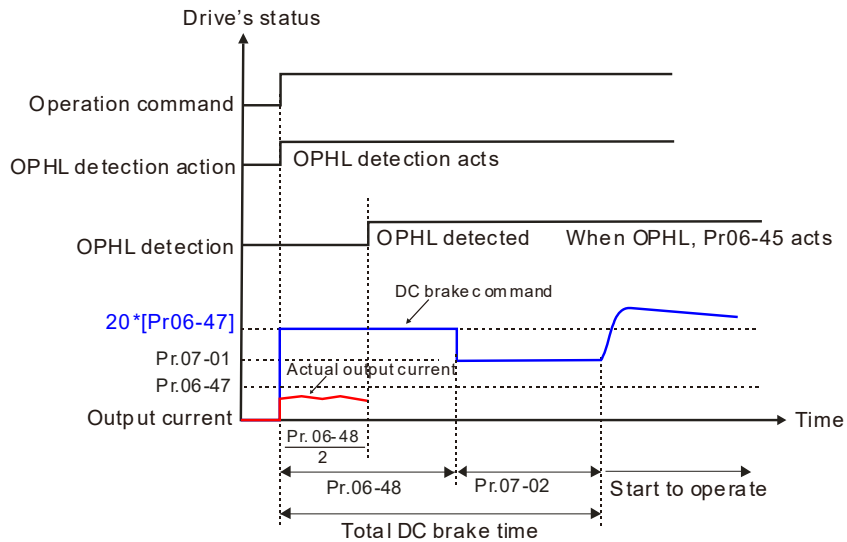

Status 4: Motor drive is in stop; Pr.06-48 ≠ 0 ; Pr.07-02=0

When motor drive starts, it will perform Pr.06-48 as DC brake. The DC brake current level is 20 times of Pr.06-47 setting value. In this period, if OPHL happens, motor drive starts to count Pr.06-48/2 time, motor drive will perform Pr.06-45 setting.

Status 4-1: Pr06-48 ≠ 0, Pr07-02=0 (No OPHL detected before operation)

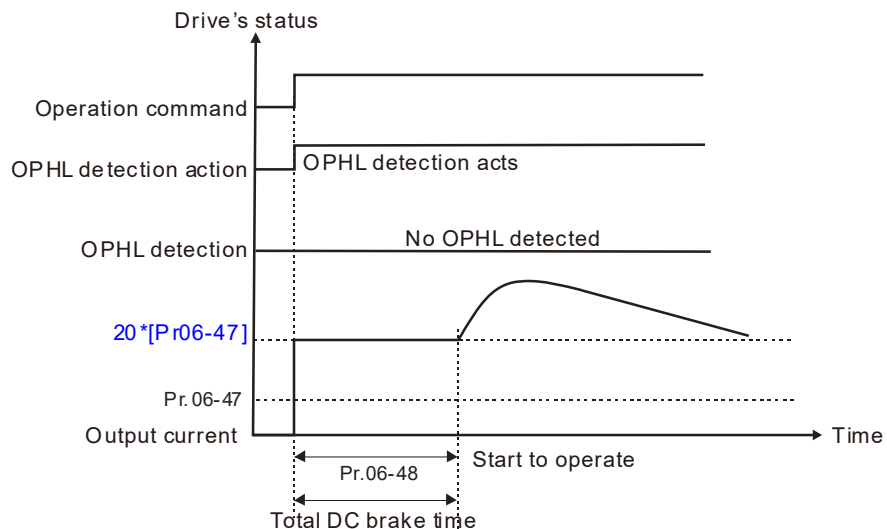

Status 4-2: Pr06-48 ≠ 0, Pr07-02=0 (OPHL detected before operation)

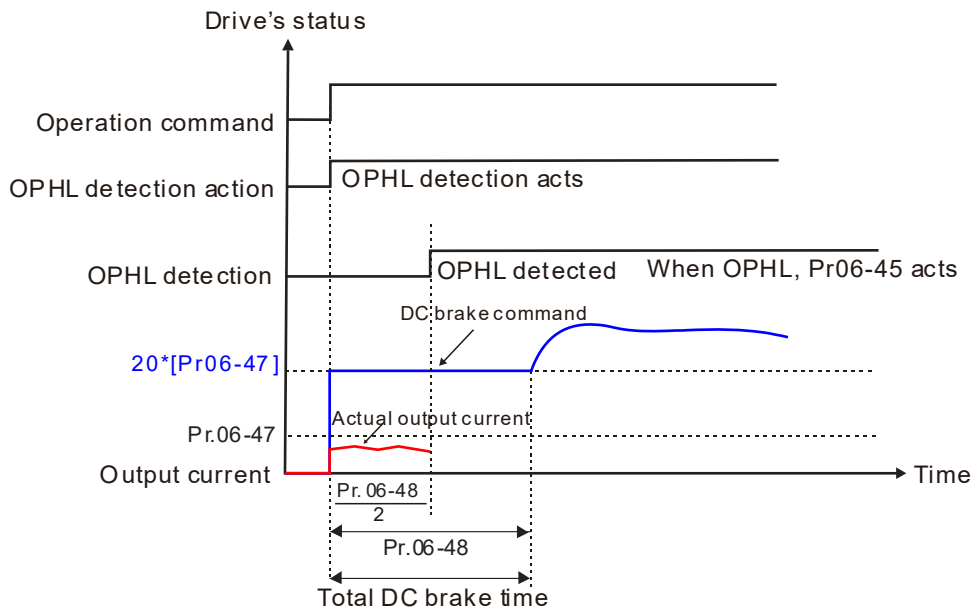

06-49 LvX Auto Reset

Factory Setting: 0

Settings 0: Disable
1: Enable

06-50 Time for Input Phase Loss Detection

Factory Setting: 0.20

Settings 0.00~600.00 sec

Pr06-50 is the time for input phase loss detection, pre-setting 0.20 sec represents check every 0.20 sec.

06-52 Ripple of Input Phase Loss

Factory Setting: 60.0

Settings 0.0~200.0 VDC

When the DC BUS ripple is higher than Pr.06-52, and continue Pr.06-50 plus 30 seconds, drive will trip up OrP and act depending on the setting of Pr.06-53 to stop.

In the time period Pr.06-50 plus 30 seconds, if the DC BUS ripple is lower than Pr.06-52, the OrP protection counter will be restart.

06-53 Treatment for the detected Input Phase Loss (OrP)

Factory Setting: 0

Settings 0: warn, ramp to stop
1: warn, coast to stop

We can get DC BUS ripple voltage via Pr.06-50 ripple time · when the condition is satisfy, drive will active the protection of Input Phase Loss according to Pr.06-53 settings:

- ◆ DC BUS ripple frequency $\leq 166\text{Hz}$.
- ◆ The amplitude is higher than Pr.06-52 settings (default 60V), it will start to count time after 20 consecutive times.
- ◆ When continue the following conditions at the time, ORP will occur.

(I) % is rated current percentage

(I) %	Actual seconds
50	432
75	225
120	60

When any condition is not satisfied, the ORP protect function will be recalculated.

06-55 Derating Protection

Factory Setting: 0

Settings 0: constant rated current and limit carrier wave by load current and temperature

1: constant carrier frequency and limit load current by setting carrier wave

2: constant rated current(same as setting 0), but close current limit

The Max. output frequency and its corresponded carrier frequency lower limit under each control mode:

- VF, SVC: 599Hz, 6K
- FOC sensorless (IM): 300Hz, 6K
- FOC sensorless (PM): 500Hz, 10K

Setting 0:

When the rated current is constant, carrier frequency (Fc) outputted by PWM will auto decrease according to surrounding temperature, overload output current and time. If overload situation is not frequent and only cares the carrier frequency operated with the rated current for a long time and carrier wave changes during short overload, it is recommended to set to 0.

Refer to the following diagram for the level of carrier frequency. Take VFD007FP4EA-52 in normal duty as example, surrounding temperature 50°C with independent installation and UL open-type. When the carrier frequency is set to 15kHz, it corresponds to 72% rated output current. When it outputs higher than the value, it will auto decrease the carrier frequency. If the output is 83% rated current and the carrier frequency will decrease to 12kHz. In addition, it will also decrease the carrier frequency when overload. When the carrier frequency is 15kHz and the current is $120\% \times 72\% = 86\%$ for a minute, the carrier frequency will decrease to the factory setting.

Setting 1:

It is used for the fixed carrier frequency and prevents the carrier wave changes and motor noise caused by the surrounding temperature and frequent overload.

Refer to the following for the derating level of rated current. Take VFD007FP4EA-52 in normal duty as example, when the carrier frequency keeps in 15kHz and the rated current is decreased to 72%, it will have OL protection when the current is $120\% \times 72\% = 86\%$ for a minute. Therefore, it needs to operate by the curve to keep the carrier frequency.

Setting 2:

It sets the protection method and action to 0 and disables the current limit for the Ratio*160% of output current in the normal duty and Ratio*180% of output current in the heavy duty. The advantage is that it can provide higher output current when the setting is higher than the factory setting of carrier frequency. The disadvantage is that it decreases carrier wave easily when overload.

- It should be used with Pr.00-16 and Pr.00-17 for setting.
- Ambient temperature will also affect the derating, please refer to ambient temperature derating curve.

Ambient Temperature derating Curve for General Control Model

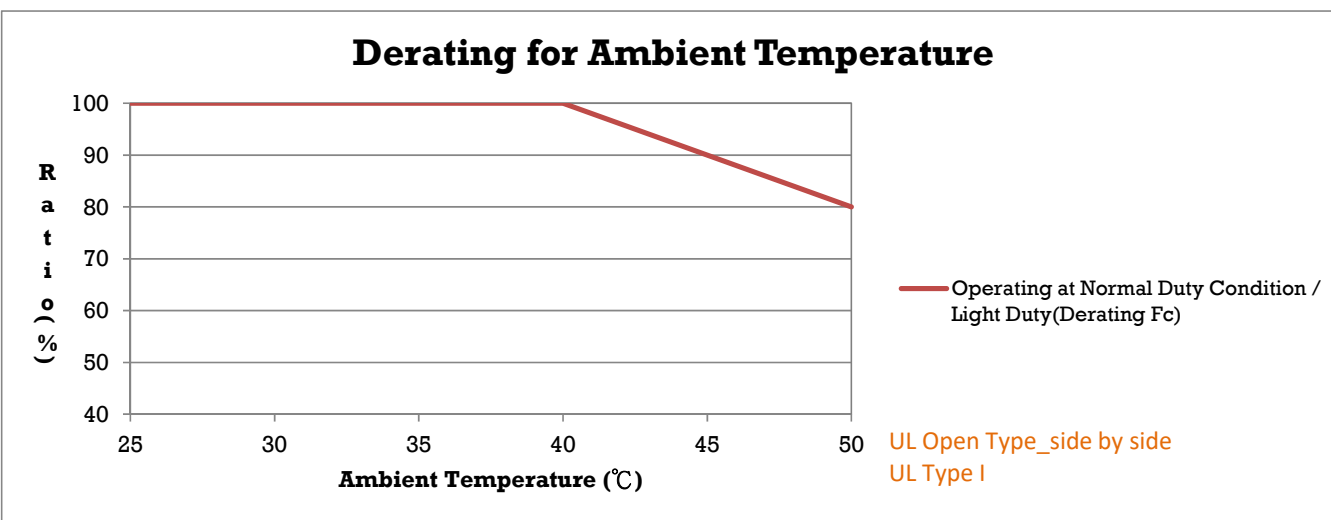
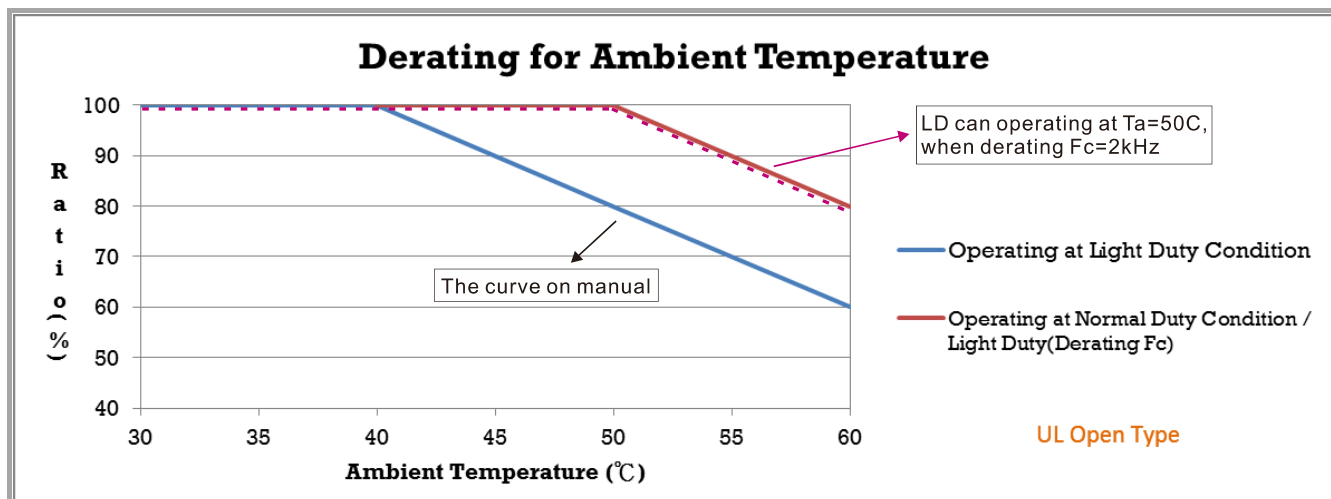
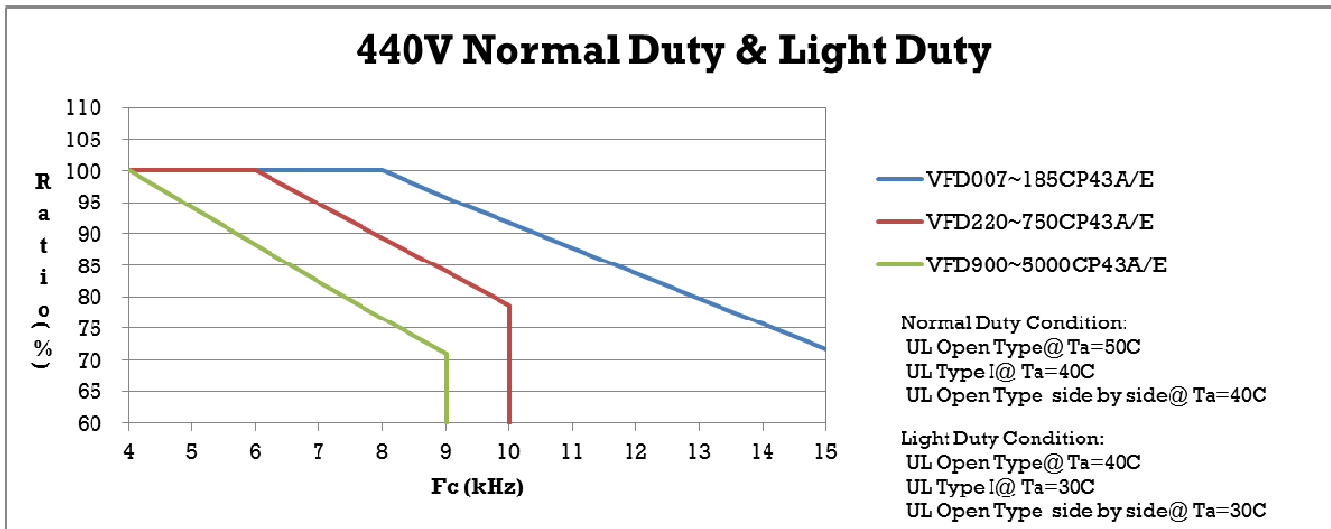

↗ 06-56 PT100 Detection Level 1	Factory Setting: 5.000
Settings 0.000~10.000V	
↗ 06-57 PT100 Detection Level 2	Factory Setting: 7.000
Settings 0.000~10.000V	
📖 Make sure Pr. 06-57 > Pr.06-56.	
↗ 06-58 PT100 Level 1 Frequency Protection	Factory Setting: 0.00
Settings 0.00~599.00 Hz	
↗ 06-59 PT100 activation level delay time	Factory Setting: 60 sec
Settings 0~6000 sec	

📖 PT100 operation

- (1) Use AVI1, AVI2 or ACI (set to 0~10V) for analog voltage input and select PT100 mode.
- (2) Choose one of the analog voltage input type: (a) AVI1(Pr.03-00=11), (b) AVI2 (Pr.03-02=11), or (c) ACI (Pr.03-01=11 and Pr.03-29=1).
- (3) When using ACI as analog voltage input, set Pr.03-01=11 and Pr.03-29=1. Then switch SW4 to 0~10V on the I/O control terminal block.
- (4) Set Pr.03-23=23 and AFM2 to constant current output. Switch AFM2 (SW2) to 0~20mA on the I/O control terminal block and set constant current output to 9mA by setting Pr.03-33=45. The AFM2 constant output current is $20\text{mA} * 45\% = 9\text{mA}$.
- (5) Pr.03-33 is for adjusting the constant voltage or constant current of AFM2, the setting range is 0~100.00%.
- (6) There are two types of action level for PT100. The diagram of PT protecting action is shown as below:

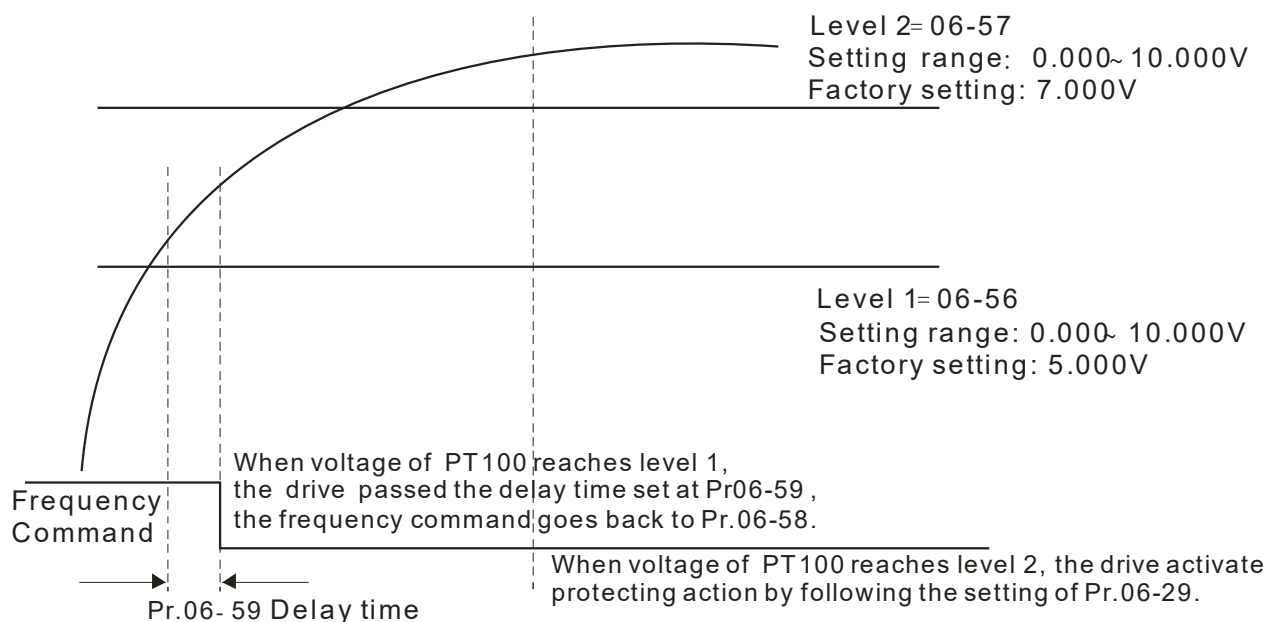

(7) PT100 wiring diagram:

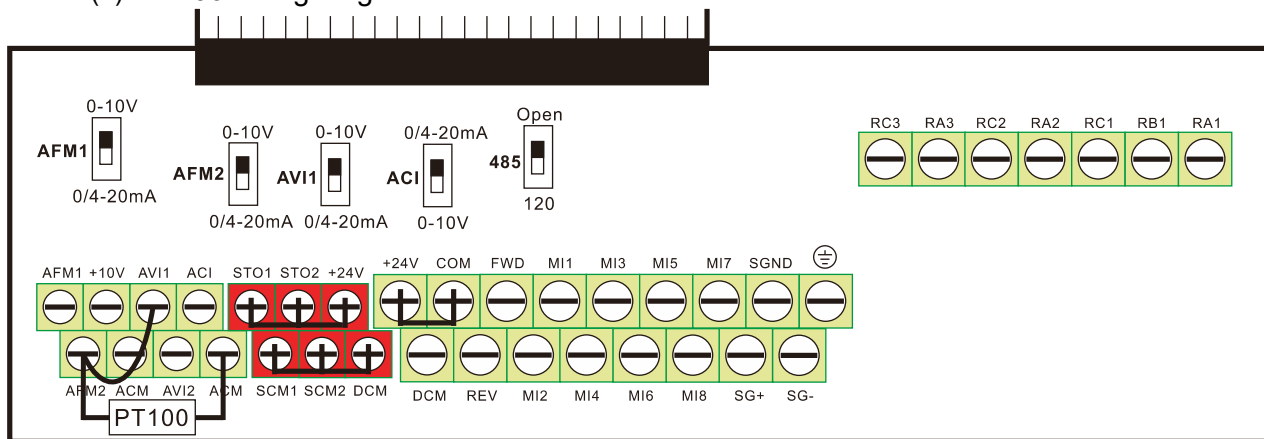

Figure 1

When Pr.06-58=0.00Hz, PT100 function is disabled.

Example:

A PT100 is installed to the drive. If motor temperature reaches 135°C (275°F) or higher, the drive will decrease motor frequency to the setting of Pr.06-58. Motor will operate at this frequency (Pr.06-58) till the motor temperature decreases to 135°C (275°F) or lower. If motor temperature exceeds 150°C (302°F), the motor will decelerate to stop and outputs an ‘OH3’ warning.

Set up process:

1. Switch AFM2 (SW2) to 0~20mA on the I/O control terminal block. (Refer to Figure 1, PT100 wiring diagram)
2. Wiring (Refer to Figure 1, PT100 wiring diagram):
 Connect external terminal AFM2 to (+)
 Connect external terminal ACM to (-)
 Connect external terminals AFM2 and AVI1 to short-circuit
3. Set Pr.03-00=11 or Pr.03-23=23 or Pr.03-33=45%(9mA)
4. Refer to RTD temperature and resistance comparison table
 Temperature=135°C, resistance=151.71Ω; Input current: 9mA, Voltage: approximately: 1.37Vdc
 Temperature=150°C, resistance=157.33Ω; Input current: 9mA, Voltage: approximately: 1.42Vdc
5. Set Pr.06=56=1.37 and Pr.06-58=10Hz. When RTD temperature increases to 135°C or higher, the drive will decelerate to the selected frequency. When Pr.06-58=0, the drive will not run.
6. Set Pr.06-57=1.42 and Pr.06-29=1 (warning and decelerate to stop). When RTD temperature increases to 150°C or higher, the drive will decelerate to stop and outputs an ‘OH3’ warning.

↗	06-60	Software Detection GFF Current Level	Factory Setting: 60.0
	Settings	0.0~6553.5 %	
↗	06-61	Software Detection GFF Filter Time	Factory Setting: 0.10
	Settings	0.00~655.35 sec	

When the motor drive detects the unbalanced three-phase out current is higher than the setting of Pr.06-60, GFF protection will be activated. Then the motor drive will stop outputting.

06-63	Fault Record 1 (day)
06-65	Fault Record 2 (day)
06-67	Fault Record 3 (day)
06-69	Fault Record 4 (day)

Factory Setting: Read only

Settings 0~65535 days

06-64	Fault Record 1 (min)
06-66	Fault Record 2 (min)
06-68	Fault Record 3 (min)
06-70	Fault Record 4 (min)

Factory Setting: Read only

Settings 0~1439 min

📖 When there is any malfunctions in motor drive operation, Pr.06-17~22 will record 6 malfunctions recently, and Pr.06-63~70 can record the operation time for 4 malfunctions in sequence. It can help to check if there is any wrong with the drive according to the recorded internal time. For example: The first error: ocA occurs in 1000 minutes after motor drive start operation. The second error: ocd happens after another 1000 minutes. The 4th error: ocA happens after another 1000 minutes. Then, the 5th error is ocd, happening 1000 minutes following 4th error. Last, 6th error ocn happens 1000 minutes after 5th error.

Then Pr.06-17~Pr.06-22 and Pr.06-63~Pr.06-70 will be:

	1 st fault	2 nd fault	3 rd fault	4 th fault	5 th fault	6 th fault
06-17	ocA	ocd	ocn	ocA	ocd	ocn
06-18	0	ocA	ocd	ocn	ocA	ocd
06-19	0	0	ocA	ocd	ocn	ocA
06-20	0	0	0	ocA	ocd	ocn
06-21	0	0	0	0	ocA	ocd
06-22	0	0	0	0	0	ocA
06-63	0	1	2	2	3	4
06-64	1000	560	120	1120	680	240
06-65	0	0	1	2	2	3
06-66	0	1000	560	120	1120	680
06-67	0	0	0	1	2	2
06-68	0	0	1000	560	120	1120
06-69	0	0	0	0	1	2
06-70	0	0	0	1000	560	120

※ From time record, it can be known that the last fault (Pr.06-17) happened after the drive run for 4days and 240 minutes.

06-71 Low Current Setting Level

Factory Setting: 0.0

Settings 0.0 ~ 100.0 %

06-72 Low Current Detection Time

Factory Setting: 0.00

Settings 0.00 ~ 360.00 sec

06-73 Treatment for low current

Factory Setting: 0

Settings

- 0 : No function
- 1 : warn and coast to stop
- 2 : warn and ramp to stop by 2nd deceleration time
- 3 : warn and operation continue

 The drive will operate as the setting of Pr.06-73 when output current is lower than the setting of Pr.06-71 and when low current continues for a period longer than the setting of Pr.06-72. This parameter can also be used with external multi-function output terminal 44 (MO44) for low current output.

 The low current detection function will not be executed when drive is at sleep or standby status.

 The low current setting level of Pr06-71 is based on drive's rated current, Pr00-01(Motor Drive Rated Current)* Pr06-71(Low Current Setting Level)% = low current detection level (A). The setting of drive's rated current related to Pr00-16(Load Selection) to change Pr00-01(Motor Drive Rated Current).

06-76 dEb motion offset setting

Factory Setting: 40.0

Settings 0.00 ~ 200.0VDC

06-80 Fire Mode

Factory Setting: 0.00

Settings

- 0: No Function
- 1: Forward Operation
- 2: Reverse Operation

 This parameter needs to work with multi-input function terminal #58 or #59 and multi-output function terminal #53 and #54.

Setting is 0: Fire mode is disabled

Setting is 1: When the drive is at Fire mode, drive will run the motor with forward direction.

Setting is 2: When the drive is at Fire mode, drive will run the motor with reverse direction.

06-81 Operating Frequency when running Fire Mode

Factory Setting: 60.00

Settings 0.00 ~ 599.00 Hz

 This parameter is to set up the drive's frequency when the fire mode is enabled.

↗ **06-82** Enable Bypass on Fire Mode

Factory Setting: 0.

Settings 0: Disable Bypass
1: Enable Bypass

↗ **06-83** Bypass Delay Time on Fire Mode

Factory Setting: 0.0

Settings 0.00 ~ 6550.0 seconds

↗ **06-84** Number of Times of Unusual Reset at Fire Mode

Factory Setting: 0

Settings 0 ~ 10

↗ **06-85** Length of Time of Unusual Reset

Factory Setting: 60.0

Settings 0.00 ~ 6000.0sec

📖 The settings of Pr.06-82 to Pr.06-85 decide if switch motors to operating under mains electricity.
Diagram of Bypass function's Sequence

06-86 Fire mode motion

Factory Setting: 0

Settings Bit0: 0=Open Loop; 1=Close Loop (PID control)
Bit1: 0=Manual reset fire mode; 1=Auto reset fire mode
0: Open loop control & manual reset fire mode
1: Close loop control & manual reset fire mode
2: Open loop control & auto reset fire mode
3: Close loop control & auto reset fire mode

06-87 Fire mode PID set point

Factory Setting: 0.0

Settings 0~100.00% (according to Pr.01-00 Max. operation frequency)

📖 Pr. 06-87 is the Fire mode PID set point when the Pr. 06-86 bit 0=1.

Fire mode operation procedure is shown in the following flowchart. The operation mode will accord to the Pr. 06-86 Bit0 setting (Bit0: 0=Open Loop; 1=Close Loop (PID control)).

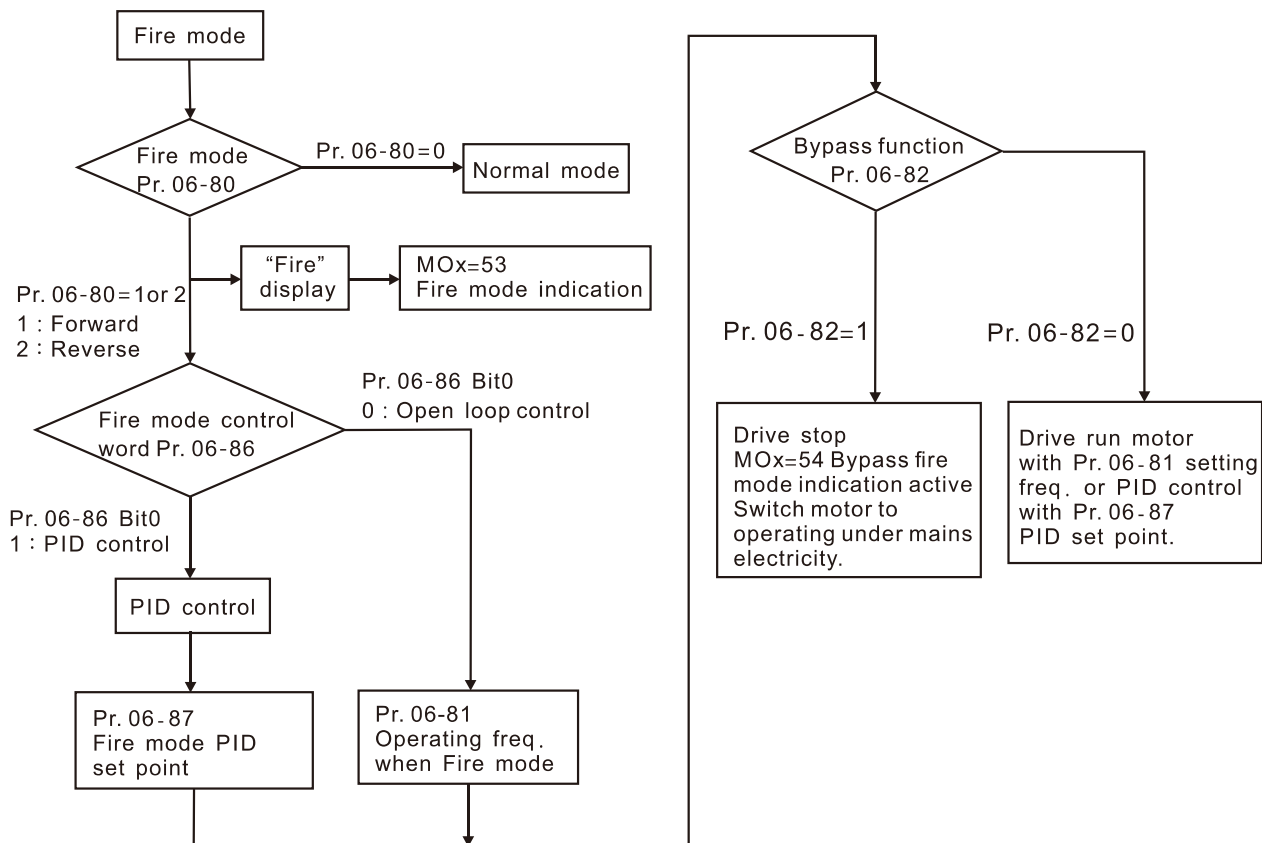

The Fire mode operating procedure:

Pr. 06-86 Bit0=0: When the Pr. 06-80=1 or 2, and the multi-functional input terminals Mlx=58 has been turned ON, then drive will start the fire mode operation. The drive will speeds up to the setting frequency of Pr. 06-81, and the KPC-CC01 displays a “Fire” warning. If the multi-functional output terminals MOx=53, this terminal will be closed. If the Pr. 06-82=1 enabled the Bypass function and the condition is established, the MOx=54 Bypass fire mode will indicate action and switch the power source of the motor to the mains power, and the drive stops.

Pr. 06-86 Bit0=1: When the Pr. 06-80=1 or 2, and the multi-functional input terminals Mlx=58 has been turned ON, then drive will start the fire mode operation. The drive will run PID control with Pr. 06-87 as PID set point, and the KPC-CC01 displays a “Fire” warning. If the multi-functional output terminals MOx=53, this terminal will be closed. If the Pr. 06-82=1 enabled the Bypass function and the condition is established, the MOx=54 Bypass fire mode will indicate action and switch the power source of the motor to the mains power, and the drive stops.

If the PID feedback signal occurs abnormally, the drive switches to the open loop and runs at the set frequency of Pr. 06-81.

Bypass function operating time chart

Conditions required for enable the Bypass function (Pr. 06-82 is set to 1):

- (1) When operating at fire mode, there is error (as shown in the table below) and the fire alarm rings according to the time setting of Pr.06-83, then the bypass function will be enabled. MFO bypass indication will be ON.
- (2) When operating at fire mode, there is an error on auto-reset and the number of time to auto-reset remains zero or the fire alarm rings according to the time setting of Pr.06-83, then the bypass function will be enabled. MFO bypass indication will be ON. If the auto reset is

successful before the bypass function is enabled, then the bypass delay counter will return to zero to wait for next trigger.

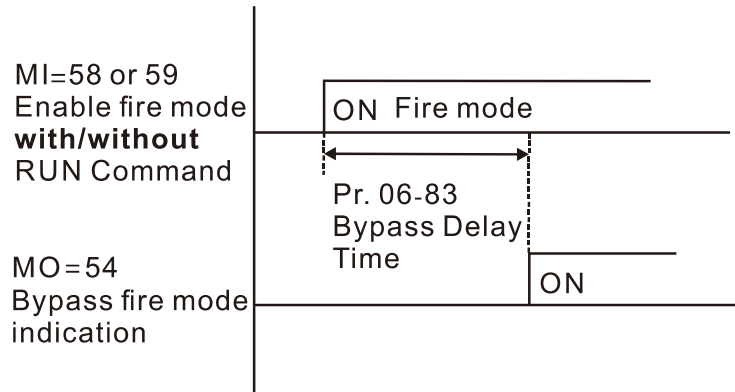

Table 1: Error detection under Normal mode, Fire mode and Bypass function at Fire mode. (V means detectable)

Code	Error name	Normal mode	Fire Mode	Enable bypass function
1	Over current during Acceleration (ocA)	V(RS)	V(able to auto-reset)	V
2	Over current during deceleration (ocd)	V(RS)	V(able to auto-reset)	V
3	Over current during normal speed (ocn)	V(RS)	V(able to auto-reset)	V
4	Ground Fault (GFF)	V	V(able to auto-reset)	V
5	IGBT short circuit (occ)	V(RS)	V(able to auto-reset)	V
6	Over current during Stop (ocS)	V(RS)	V(able to auto-reset)	V
7	Over voltage during Acceleration (ovA)	V(RS)	V(able to auto-reset)	V
8	Over voltage during deceleration (ovd)	V(RS)	V(able to auto-reset)	V
9	Over voltage during normal speed (ovn)	V(RS)	V(able to auto-reset)	V
10	Over voltage during Stop (ovS)	V(RS)	V(able to auto-reset)	V
11	Low voltage during Acceleration (LvA)	V	Not-detectable	Not-detectable
12	Low voltage during deceleration (Lvd)	V	Not-detectable	Not-detectable
13	Low voltage during normal speed (Lvn)	V	Not-detectable	Not-detectable
14	Low voltage during Stop (LvS)	V	Not-detectable	Not-detectable
15	Input phase loss (OrP)	V	V(able to auto-reset)	V
16	Over heat 1 (oH1)	V	V(able to auto-reset)	V
17	Over heat 2 (oH2)	V	V(able to auto-reset)	V
18	Thermister 1 open (tH1o)	V	V(able to auto-reset)	V
19	Thermister 2 open (tH2o)	V	V(able to auto-reset)	V
21	Over Load (oL) (150% 1Min, Inverter)	V	Not-detectable	Not-detectable
22	Motor 1 over load (EoL1)	V	Not-detectable	Not-detectable
23	Motor 2 over load (EoL2)	V	Not-detectable	Not-detectable
24	Over heat 3 (oH3) (PTC)	V	V(able to auto-reset)	V
26	Over torque 1 (ot1)	V	Not-detectable	Not-detectable
27	Over torque 2 (ot2)	V	Not-detectable	Not-detectable
28	Low-current (uC)	V	Not-detectable	Not-detectable

Code	Error name	Normal mode	Fire Mode	Enable bypass function
30	EEPROM write error (cF1)	V	Not-detectable	Not-detectable
31	EEPROM read error (cF2)	V	V	Not-detectable
33	U phase current sensor detection error (cd1)	V	V	Not-detectable
34	V phase current sensor detection error (cd2)	V	V	Not-detectable
35	W phase current sensor detection error (cd3)	V	V	Not-detectable
36	Hardware Logic error 0 (Hd0) – cc	V	V	Not-detectable
37	Hardware Logic error 1 (Hd1) – oc	V	V	Not-detectable
38	Hardware Logic error 2 (Hd2) – ov	V	V	Not-detectable
39	Hardware Logic error 3 (Hd3) – occ	V	V	Not-detectable
40	Motor auto tuning error (AuE)	V	Not-detectable	Not-detectable
41	ACI feedback loss (AFE)	V	Not-detectable	Not-detectable
48	ACI Loss	V	Not-detectable	Not-detectable
49	External fault (EF)	V	Not-detectable	Not-detectable
50	Emergency stop (EF1)	V	Not-detectable	Not-detectable
51	base block (bb)	V	Not-detectable	Not-detectable
52	PcodE (Password)	V	Not-detectable	Not-detectable
53	Software code error	V	V	Not-detectable
54	Communication error 1 (cE1)	V	Not-detectable	Not-detectable
55	Communication error 2 (cE2)	V	Not-detectable	Not-detectable
56	Communication error 3 (cE3)	V	Not-detectable	Not-detectable
57	Communication error 4 (cE4)	V	Not-detectable	Not-detectable
58	cE10 (Communication Time Out)	V	Not-detectable	Not-detectable
60	Braking Transistor Fault (bf)	V	Not-detectable	Not-detectable
61	Y-Delta connected Error (ydc)	V	Not-detectable	Not-detectable
62	Decel. Energy Backup Error (dEb)	V	Not-detectable	Not-detectable
63	Over Slip Error (oSL)	V	Not-detectable	Not-detectable
64	Electromagnet switch error (ryF)	V	Not-detectable	Not-detectable
72	Channel 1 (STO1~SCM1) internal hardware error (STL1)	V	V	Not-detectable
73	External safety gate S1	V	V	Not-detectable
74	Fire Mode output	V	V(keeps on operating)	V(keeps on operating)
76	Safety Torque Off (STO)	V	V	Not-detectable
77	Channel 2 (STO2~SCM2) internal hardware error (STL2)	V	V	Not-detectable
78	Channel 1 and Channel 2 internal hardware error (STL3)	V	V	Not-detectable
79	U phase over current (Uocc)	V	Not-detectable	Not-detectable

Code	Error name	Normal mode	Fire Mode	Enable bypass function
80	V phase over current (Vocc)	V	Not-detectable	Not-detectable
81	W phase over current (Wocc)	V	Not-detectable	Not-detectable
82	OPHL U phase output phase loss	V	V(able to auto-reset)	V
83	OPHL Vphase output phase loss	V	V(able to auto-reset)	V
84	OPHL Wphase output phase loss	V	V(able to auto-reset)	V
90	Inner PLC function is forced to stop	V	Not-detectable	Not-detectable
99	CPU Trap error	V	V	Not-detectable
101	CgdE CANopen software disconnect1	V	Not-detectable	Not-detectable
102	ChbE CANopen software disconnect2	V	Not-detectable	Not-detectable
103	CSYE CANopen synchronous error	V	Not-detectable	Not-detectable
104	CbFE CANopen hardware disconnect	V	Not-detectable	Not-detectable
105	CidE CANopen index setting error	V	Not-detectable	Not-detectable
106	CadE CANopen slave station number setting error	V	Not-detectable	Not-detectable
107	CfrE CANopen index setting exceed limit	V	Not-detectable	Not-detectable
111	InrCOM Internal communication overtime error	V	Not-detectable	Not-detectable

The Fire mode reset procedure:

When the terminal MI=58 has become ON → OFF, the drive starts to run “fire mode reset procedure”, and will decide “Manual reset” or “Auto reset” fire mode according to the P06-86 bit1 selection.

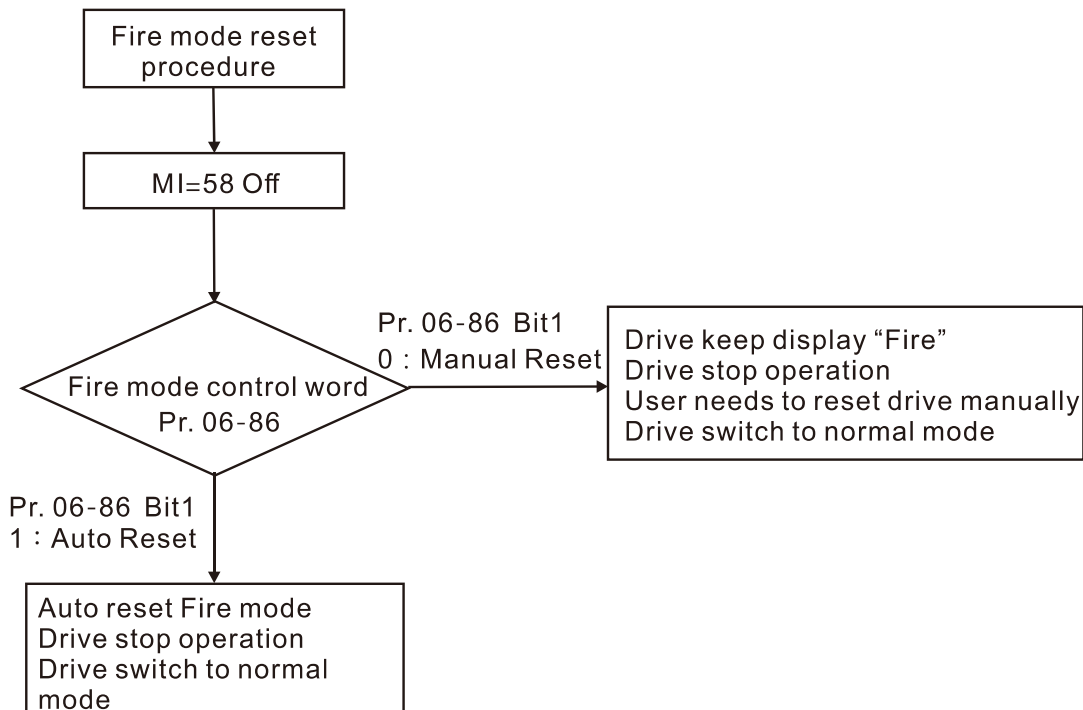







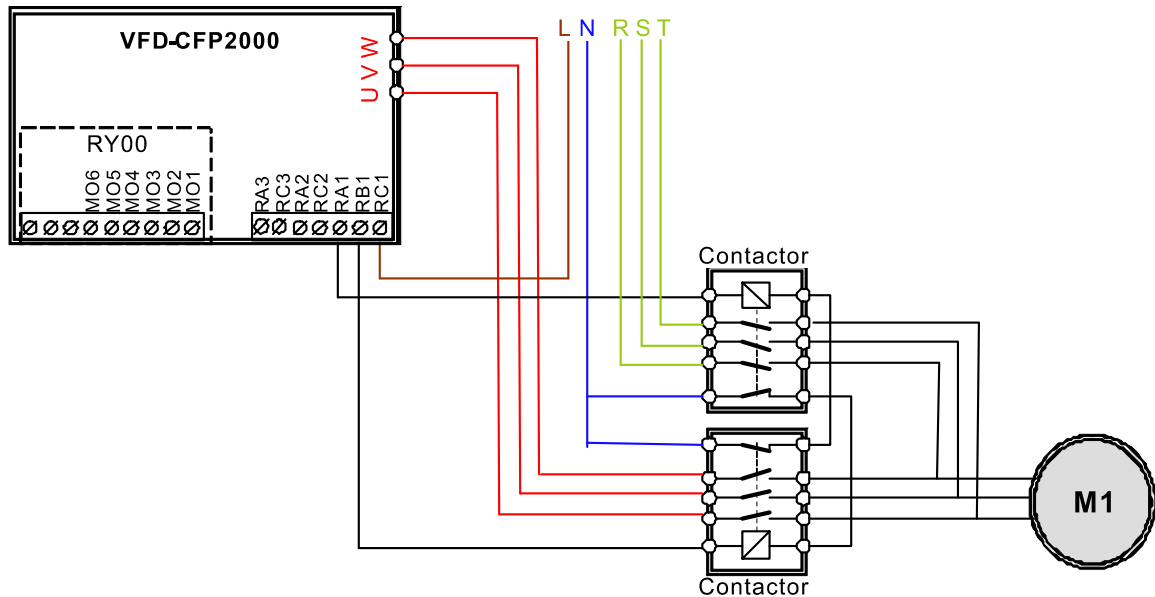



Wiring diagram:

1. When the AC power ON, RB1/ RC1 contacts=ON, and RA1/ RC1=OFF.
2. When operating at the fire mode with no bypass indication function, RB1/ RC1=ON, and the motor is driven by the drive.

3. When operating at the fire mode with bypass function enabled, RA1/ RC1=ON, and the motor is driven by the mains power.



- 📖 In fire mode, the driver operating direction refers to Pr. 06-80=1 (forward) or Pr. 06-80=2 (reverse). Other operating direction commands are not valid. The P00-23 Motor Operating Direction Control function is invalid.
- 📖 All KPC-CC01 keypad commands are ignored in fire mode (includes Run, Stop, JOG, direction commands).
- 📖 All RS485 communication commands are ignored in fire mode (includes Run, Stop, JOG, direction commands).
- 📖 In fire mode, the function “B.B” and “EF” cannot work (including external terminal B.B, communication B.B, external terminal EF, communication EF, external terminal EF1). If the B.B is in action, it will be automatically invalidated (including external terminals B.B, communication B.B) and the driver will execute speed search.
- 📖 In fire mode, if the EF and EF1 are in action, they will be automatically invalidated (including external terminals EF & EF1, communication EF).
- 📖 In fire mode, the JOG command is invalid (JOG command Source: Keypad, external terminals, communications). If the JOG command is in action, it will be automatically invalidated.
- 📖 In fire mode, the Acceleration / Deceleration Speed Inhibit function is invalid. If this function is in action, it will be automatically invalidated.
- 📖 In fire mode, if the Pr. 06-86 Bit0=0 (Open Loop), the driver does not perform 08 group PID function. If 08 group PID functions are in action, it will be automatically invalidated.
- 📖 In fire mode, the Hand-Off-Auto function is invalid (including multi-function output terminals).
- 📖 No Circulative Control function is performed in fire mode, and all circulating control function parameters will be cleared. If the “circulative control” is in action, it will be automatically invalidated.
- 📖 No sleep function is performed in fire mode.
- 📖 The DC Brake function is not performed in fire mode. The DC brake in action will be automatically invalidated.

-  In fire mode, the Over Current Stall Prevention function is invalid. The over-current stall prevention in action will be automatically invalidated.
-  No OL detection function detection in fire mode.
-  No OL1/OL2 detection function in fire mode.
-  Abnormal communication (CE10, CE01, CE02, CE03, CE04) detection is invalid in fire mode.
-  The cd1,cd2,cd3 and Hd0,Hd1,Hd2,Hd3 are boot checking and cannot be reset. The above errors cannot be reset in fire mode as well. The drive is not functioning in fire mode.
-  In fire mode, the driver will not trip up by LV error and will keep running or completely no electricity. If the LV error is happened before fire mode warning, reset the LV error to operate the driver.
-  After the MOx=54 Bypass fire mode indication is activated, the only way to turn off MOx=54 is reset the fire warning and re-power ON again.
-  The output stop function is invalid in fire mode.
-  In fire mode, skip frequency function is invalid.
-  The Pr. 06-81 Operating Frequency cannot be greater than the Pr. 01-00 Maximum output frequency under Fire Mode. If Pr. 06-81 > Pr. 01-00, then the output frequency will be automatically limited to Pr. 01-00.

07 Special Parameters

✎ This parameter can be set during operation.

-
- ✎ **07-00** Software Brake Level Factory Setting: 740.0
- Settings 700.0~900.0VDC
-
- 📖 This parameter sets the DC-bus voltage at which the brake chopper is activated. Users can choose the suitable brake resistor to have the best deceleration. Refer to Chapter 7 Accessories for the information of the brake resistor.
- 📖 It is only valid for the models below 30kW of 460 series.
-
- ✎ **07-01** DC Brake Current Level Factory Setting: 0
- Settings 0~100%
-
- 📖 This parameter sets the level of DC Brake Current output to the motor during start-up and stopping. When setting DC Brake Current, the Rated Current is regarded as 100%. It is recommended to start with a low DC Brake Current Level and then increase until proper holding torque has been attained.
-
- ✎ **07-02** DC Brake Time at RUN Factory Setting: 0.0
- Settings 0.0~60.0 sec
-
- 📖 The motor may be in the rotation status due to external force or itself inertia. If the drive is used with the motor at this moment, it may cause motor damage or drive protection due to over current. This parameter can be used to output DC current before motor operation to stop the motor and get a stable start. This parameter determines the duration of the DC Brake current after a RUN command. When it is set to 0.0, it is invalid.
-
- ✎ **07-03** DC Brake Time at Stop Factory Setting: 0.0
- Settings 0.0~60.0 sec
-
- 📖 The motor may be in the rotation status after drive stop outputting due to external force or itself inertia and can't stop accurately. This parameter can output DC current to force the motor drive stop after drive stops to make sure that the motor is stop.
- 📖 This parameter determines the duration of the DC Brake current during stopping. To DC brake at stop, this function will be valid when Pr.00-22 is set to 0 or 2. When setting to 0.0, it is invalid.
- 📖 Related parameters: Pr.00-22 Stop Method, Pr.07-04 Start-point for DC Brake
-
- ✎ **07-04** DC Brake Frequency at STOP Factory Setting: 0.00
- Settings 0.00~599.00Hz
-
- 📖 This parameter determines the frequency when DC Brake will begin during deceleration. When this setting is less than start frequency (Pr.01-09), the start-point for DC brake will start from the min. frequency.

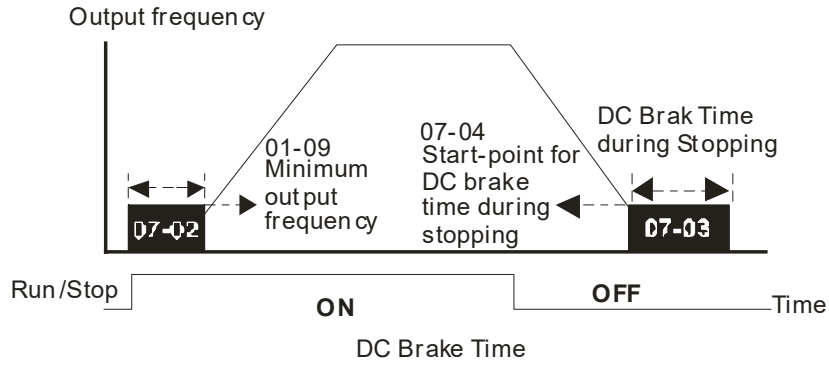

- 📖 DC Brake at Start-up is used for loads that may move before the AC drive starts, such as fans and pumps. Under such circumstances, DC Brake can be used to hold the load in position before setting it in motion.
- 📖 DC Brake at stop is used to shorten the stopping time and also to hold a stopped load in position, such as crane or cutting machine.

➤ **07-05** Voltage Increasing Gain

Factory Setting: 100

Settings 1~200%

- 📖 When the user is using speed tracking, adjust Pr07-05 to slow down the increasing of voltage if there are errors such as oL or oc.

➤ **07-06** Restart after Momentary Power Loss

Factory Setting: 0

Settings 0: Stop operation
 1: Speed search for last frequency command
 2: Speed search for the minimum output frequency

- 📖 This parameter determines the operation mode when the AC motor drive restarts from a momentary power loss.
- 📖 The power connected to the drive may power off momentarily due to many reasons. This function allows the drive to keep outputting after power is on again after power off and won't cause drive stops.
- 📖 Setting 1: Operation continues after momentary power loss, speed search starts with the Master Frequency reference value after drive output frequency and motor rotator speed is synchronous. The motor has the characteristics of big inertia and small obstruction. For example, in the equipment with big inertia wheel, it doesn't need to wait to execute operation command until wheel is complete stop after re-start to save time.
- 📖 Setting 2: Operation continues after momentary power loss, speed search starts with the minimum output frequency after drive output frequency and motor rotator speed is synchronous. The motor has the characteristics of small inertia and bigger obstruction.
- 📖 This function is valid when the Run command is present.

➤ **07-07** Maximum Power Loss Duration

Factory Setting: 2.0

Settings 0.0~20.0 sec

- 📖 If the duration of a power loss is less than this parameter setting, the AC motor drive will resume operation. If it exceeds the Maximum Allowable Power Loss Time, the AC motor drive output will then turn off (coast stop).
- 📖 The selected operation after power loss in Pr.07-06 is only executed when the maximum allowable power loss time is ≤ 5 seconds and the AC motor drive displays "LU".
- 📖 But if the AC motor drive is powered off due to overload, even if the maximum allowable power loss time is ≤ 5 seconds, the operation mode as set in Pr.07-06 is not executed. In that case, it starts up normally.

🔪 **07-08** Base block Time

Factory Setting: ##

Settings 0.0~5.0 (Depending on the motor power)

📖 Pr 07-08 Factory Setting:

KW	007	015	022	037	040	055	075	110	150
HP	1	2	3	5	5.5	7.5	10	15	20
Pr07-08 (sec)	0.3	0.4	0.5	0.6	0.7	0.7	0.8	0.9	1

KW	185	220	300	370	450	550	750	900
HP	25	30	40	50	60	75	100	125
Pr07-08 (sec)	1.1	1.2	1.3	1.4	1.5	1.6	1.7	1.8

- 📖 When momentary power loss is detected, the AC drive will block its output and then wait for a specified period of time (determined by Pr.07-08, called Base-Block Time) before resuming operation. This parameter should be set at a value to ensure that any residual regeneration voltage from the motor on the output has disappeared before the drive is activated again.

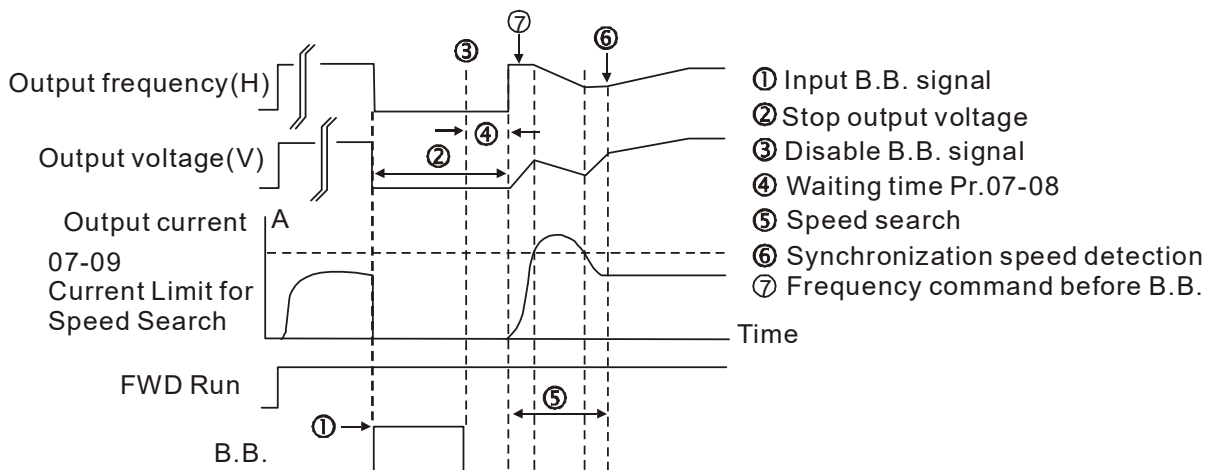

B.B. Search with last output frequency downward timing chart

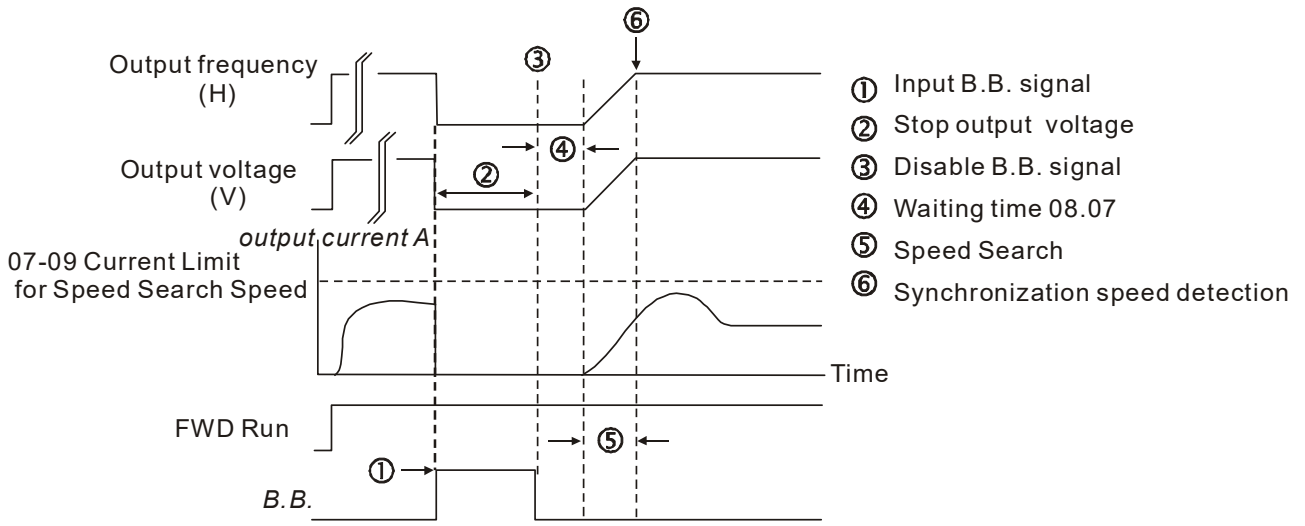

B.B. Search with minimum output frequency upward timing chart

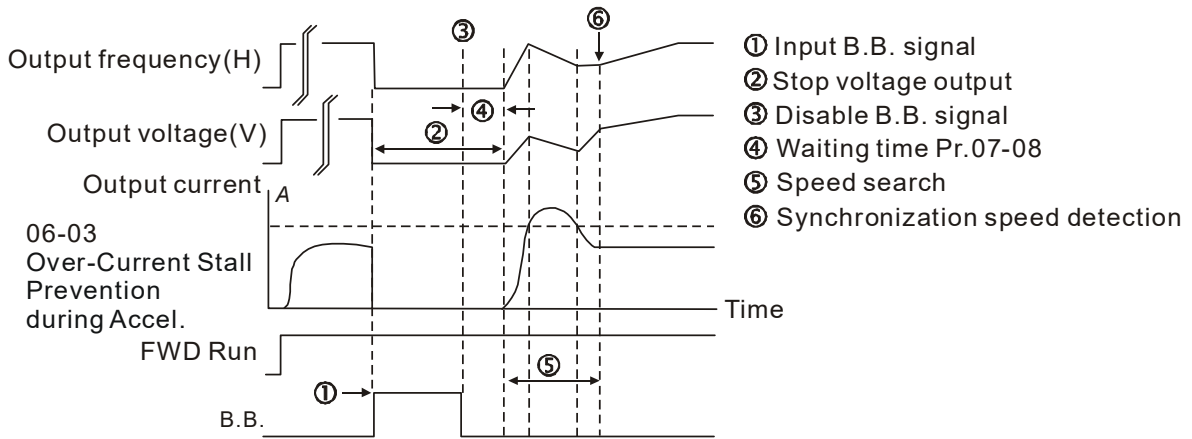

B.B. Search with minimum output frequency upward timing chart

⚡ **07-09** Current Limit for Speed Search

Factory Setting: 100

Settings 20~200%

- 📖 Following a momentary power loss, the AC motor drive will start its speed search operation only if the output current is greater than the value set by Pr.07-09.
- 📖 The maximum speed search level will affect the synchronous time. It will get the synchronization faster when this parameter is set to larger value. But too large value may activate overload protection.

⚡ **07-10** Treatment after Fault

Factory Setting: 0



- Settings
- 0: Stop operation
 - 1: Speed search starts with current speed
 - 2: Speed search starts with minimum output frequency

📖 Fault includes: bb, oc, ov and occ. To restart after oc, ov, occ, Pr.07-11 can not be set to 0.

07-11 Auto Restart Time after Fault

Factory Setting: 0

Settings 0~10

-  After fault (oc, ov, occ) occurs, the AC motor drive can be reset/restarted automatically up to 10 times.
-  Setting this parameter to 0 will disable the reset/restart operation after any fault has occurred. When enabled, the AC motor drive will restart with Pr07-10 setting after fault auto reset.
-  If the time of reset/restart exceeds Pr.07-11 setting, the fault will not be restart /reset until user reset manually and run the motor drive again.

07-12 Speed Search during Start-up

Factory Setting: 0

Settings 0: Disable

- 1: Speed search from maximum output frequency
- 2: Speed search from start-up motor frequency
- 3: Speed search from minimum output frequency









-  This parameter is used for starting and stopping a motor with a high inertia. A motor with high inertia will take 2~5 minutes or longer to stop completely. By setting this parameter, the user does not need to wait for the motor to come to a complete stop before restarting the AC motor drive. The output current is set by the Pr.07-09.

07-13 dEb Function Selection

Factory Setting: 0

Settings 0: Disable

- 1: dEb with auto accel./decel., the output frequency will not return after power reply.
- 2: dEb with auto accel./decel., the output frequency will return after power reply

-  This function is the AC motor drive decelerates to stop after momentary power loss. When the momentary power loss occurs, this function can be used for the motor to decelerate to zero speed with deceleration stop method. When the power is on again, motor will run again after DEB return time. (has applied on high-speed spindle)
-  Lv return level: Pr.06-00+60V
-  Lv level: default=Pr.06-00
-  During the dEb, the drive can also be protected by ryF, ov, oc, occ, EF...etc., and those error codes will recorded as well.
-  When dEb is in auto-deceleration, the STOP (RESET) function will be invalid, and the AC motor drive will decelerate to stop. If the AC motor drive needs to be ramp to stop immediately, use EF function instead.
-  During the dEb time, the "BB" function is ineffective until dEb is disabling.
-  Even the Lv warning does not appear during dEb time, the MO=10 "Low voltage warning" will still be activated if the DCBUS voltage is lower than the Lv level.
-  dEb actions are illustrated as below
When the DCBUS voltage drops to a level, which is smaller than the dEb activation level, the dEb function will be activated (the soft start relay is closed) and the motor drive will begin the auto-deceleration.

- Situation 1: Insufficient power supply due to momentary power-loss/unstable power (due to low voltage)/sudden heavy-load
 1. Pr07-13=1 “dEb with auto accel./ ecal., the output frequency will not return after power reply” and power restore.
 2. When the power restores and DCBUS voltage is higher than the “dEb return level”, the drive will automatically switch from coast stop to ramp stop until 0Hz and stop. The keypad will display “dEb” warning until manually reset and this can avoid that users do not know the reason for stopping.

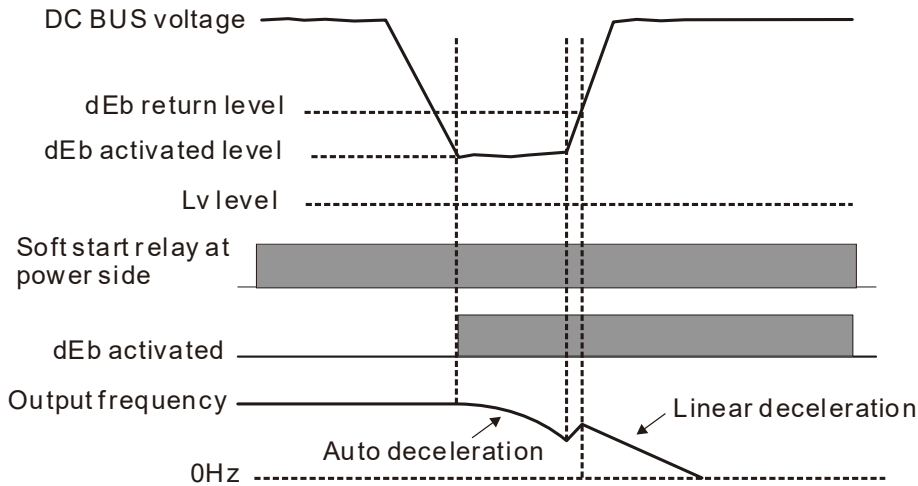

- Situation 2: Insufficient power supply due to momentary power-loss/unstable power (due to low voltage)/sudden heavy-load
 1. Pr07-13=2 “dEb with auto accel./ ecal., the output frequency will return after power reply” and power restore
 2. During the dEb deceleration time (include 0hz run), if the power restore and DCBUS voltage is higher than “dEb return level”, the drive will maintain the current frequency for 3 seconds and restart to accelerated, the dEb warning show on the keypad will then cleared automatically.

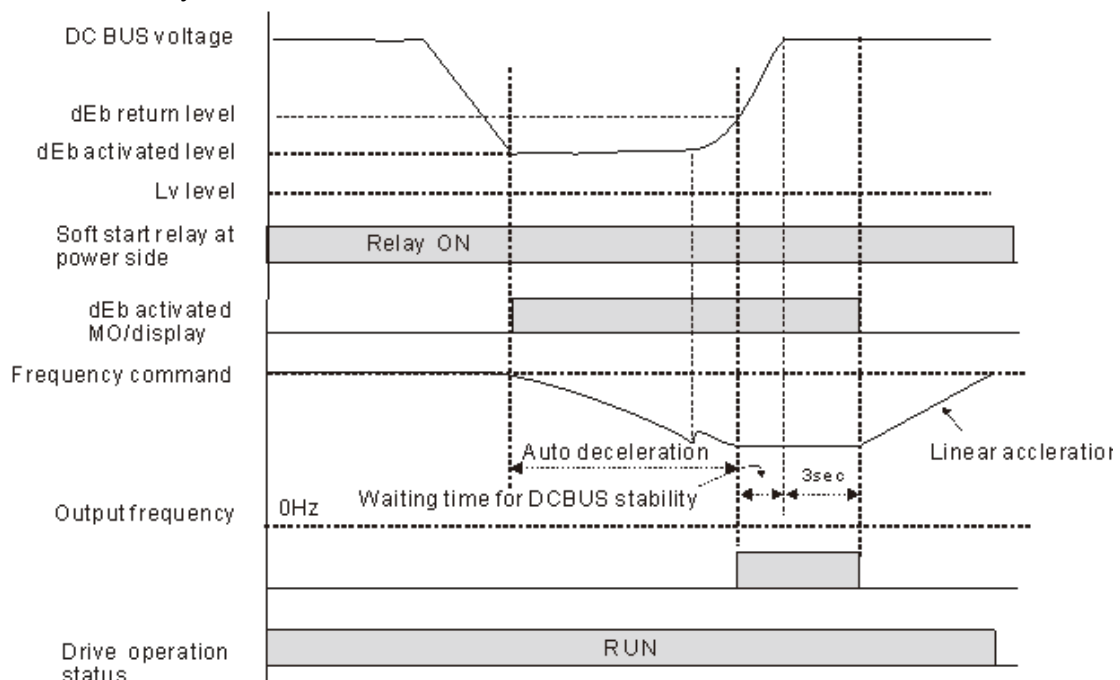

- Situation 3: Power supply unexpected shut down/power loss
 1. Pr07-13=1" dEb with auto accel./ ecal., the output frequency will not return after power restore" and power will not restore.
 2. The keypad will display "dEb" warning and decelerated to 0Hz and stop. When the DCBUS voltage has smaller than Lv level, the drive internal soft-start relay turn off and until drive is completely out of power.

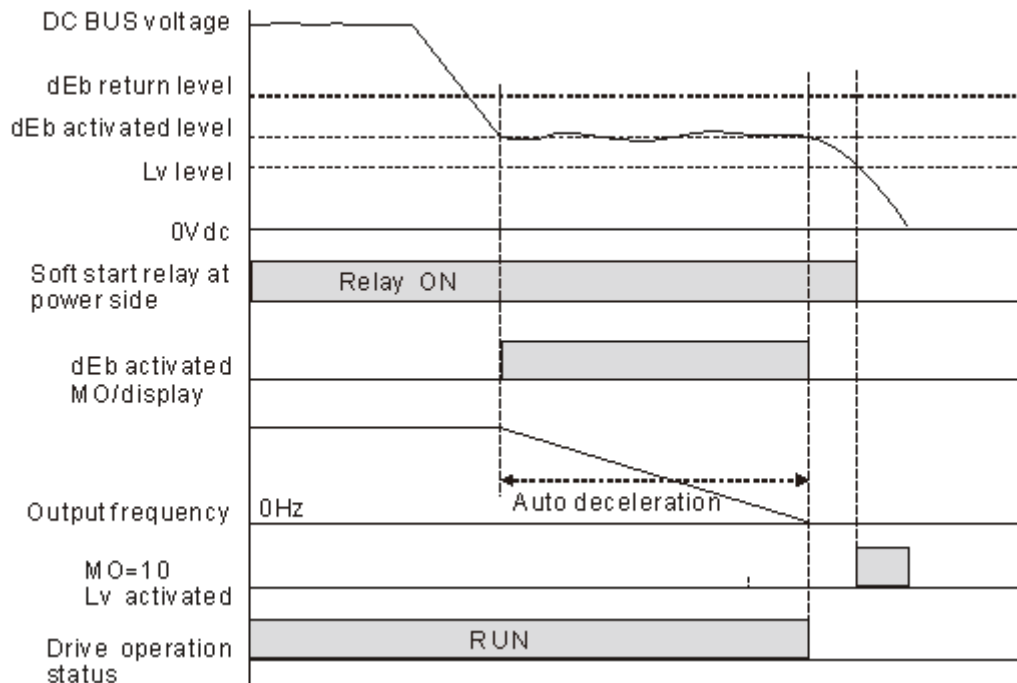

- Situation 4:
 1. Pr07-13=2 "dEb with auto accel./ ecal., the output frequency will return after power restore" and power will not restore.
 2. Same as the situation 3, the drive will decelerate to 0Hz. The DCBUS voltage will continue to reduce until the voltage is less than Lv level and drive internal soft-start relay turn-off. The keypad will display "dEb" warning until drive is completely out of power.
- Situation 5:
 1. Pr07-13=2 "dEb with auto accel./ ecal., the output frequency will return after power restore" and Power will restore after DCBUS voltage has smaller than Lv level.
 2. The drive decelerates to 0Hz and DCBUS voltage continue to reduce until the voltage is less than Lv level, drive internal soft-start relay turn-off. When the power restore and DCBUS voltage has higher than LV return level, the soft-start relay turn-on. When the DCBUS voltage has higher than dEb return level, waiting for DCBUS stability, the drive will maintain the current frequency for 3 seconds and restart to do linear accelerate, the dEb warning show on the keypad will cleared up automatically.

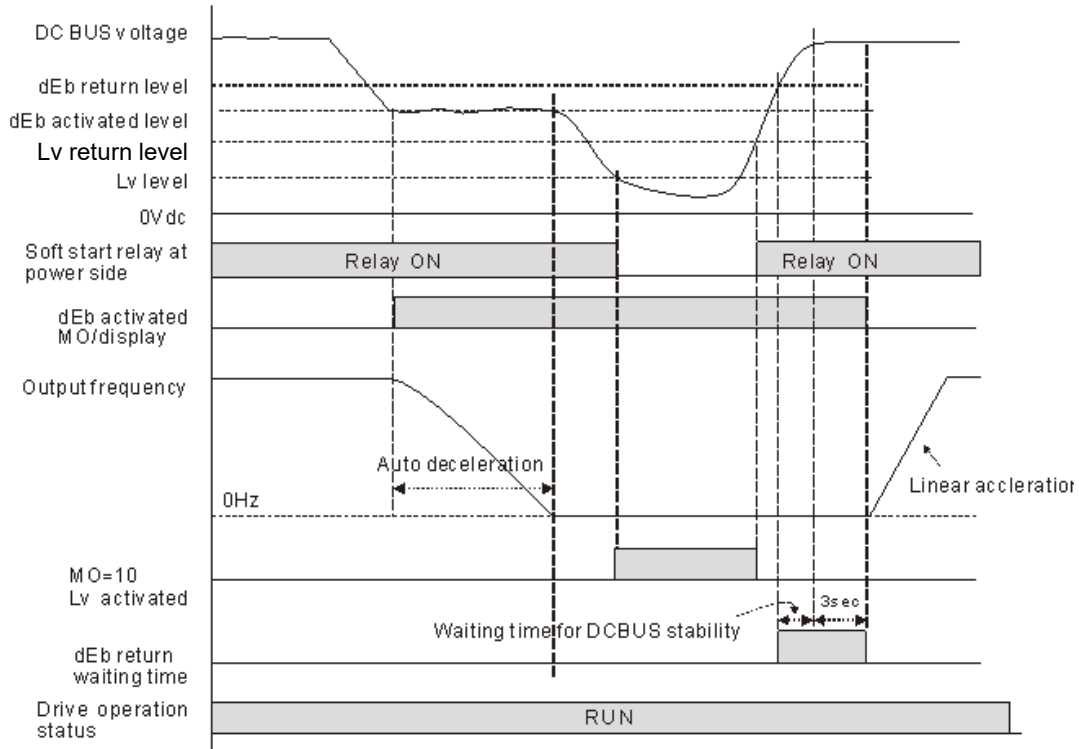

NOTE

For example, in textile machinery, you will hope that all the machines can be decelerated to stop to prevent broken stitching when power loss. In this case, the host controller will send a message to the AC motor drive to use dEb function with deceleration time via EF.

➤ **07-15** Dwell Time at Accel. Factory Setting: 0.00

Settings 0.00~600.00 sec

➤ **07-16** Dwell Frequency at Accel. Factory Setting: 0.00

Settings 0.00~599.00 Hz

➤ **07-17** Dwell Time at Decel. Factory Setting: 0.00

Settings 0.00~600.00 sec

➤ **07-18** Dwell Frequency at Decel. Factory Setting: 0.00

Settings 0.00~599.00 Hz

📖 In the heavy load situation, Dwell can make stable output frequency temporarily, such as crane or elevator.



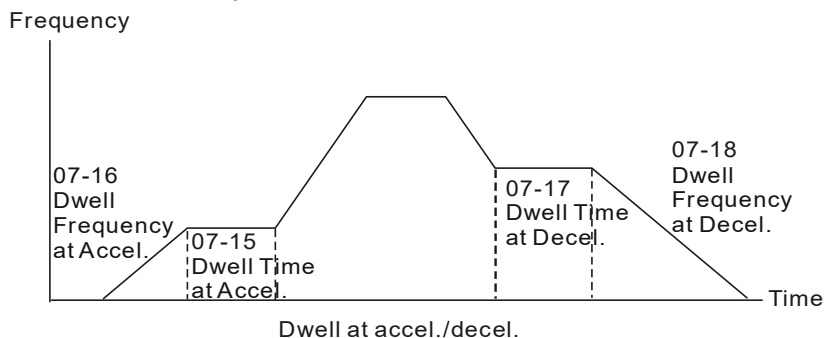



📖 Pr.07-15 to Pr.07-18 is for heavy load to prevent OV or OC occurs.



07-19 Fan Cooling Control

Factory Setting: 0

- Settings
- 0: Fan always ON
 - 1: 1 minute after the AC motor drive stops, fan will be OFF
 - 2: When the AC motor drive runs, the fan is ON. When the AC motor drive stops, the fan is OFF
 - 3: Fan turns ON when preliminary IGBT temperature (around 60°C) is attained.
 - 4: Fan always OFF

-  This parameter is used for the fan control.
-  Setting 0: Fan will be ON as the drive's power is turned ON.
-  Setting 1: 1 minute after AC motor drive stops, fan will be OFF
-  Setting 2: AC motor drive runs and fan will be ON. AC motor drive stops and fan will be OFF.
-  Setting 3: Fan run according to IGBT and capacitance temperature. Fan will be ON when IGBT temperature is higher than 60 °C. Fan will be OFF, when capacitance temperature is lower than 40°C.
-  Setting 4: Fan is always OFF

07-20 Emergency Stop (EF) & Force Stop

Factory Setting: 0

- Settings
- 0: Coast to stop
 - 1: Stop by 1st deceleration time
 - 2: Stop by 2nd deceleration time
 - 3: Stop by 3rd deceleration time
 - 4: Stop by 4th deceleration time
 - 5: System Deceleration (According to original deceleration time)
 - 6: Automatic Deceleration (Pr01-46)

-  When the multi-function input terminal is set to 10(EF) or 18(Emergency stop) and is activated, the drive will stop according to the setting in Pr.07-20.

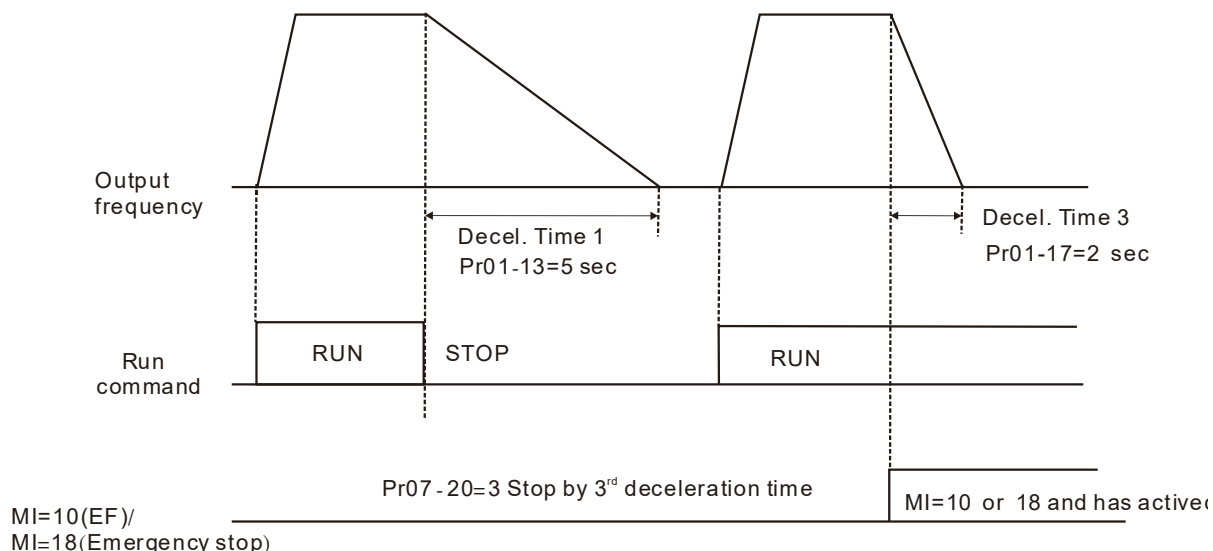

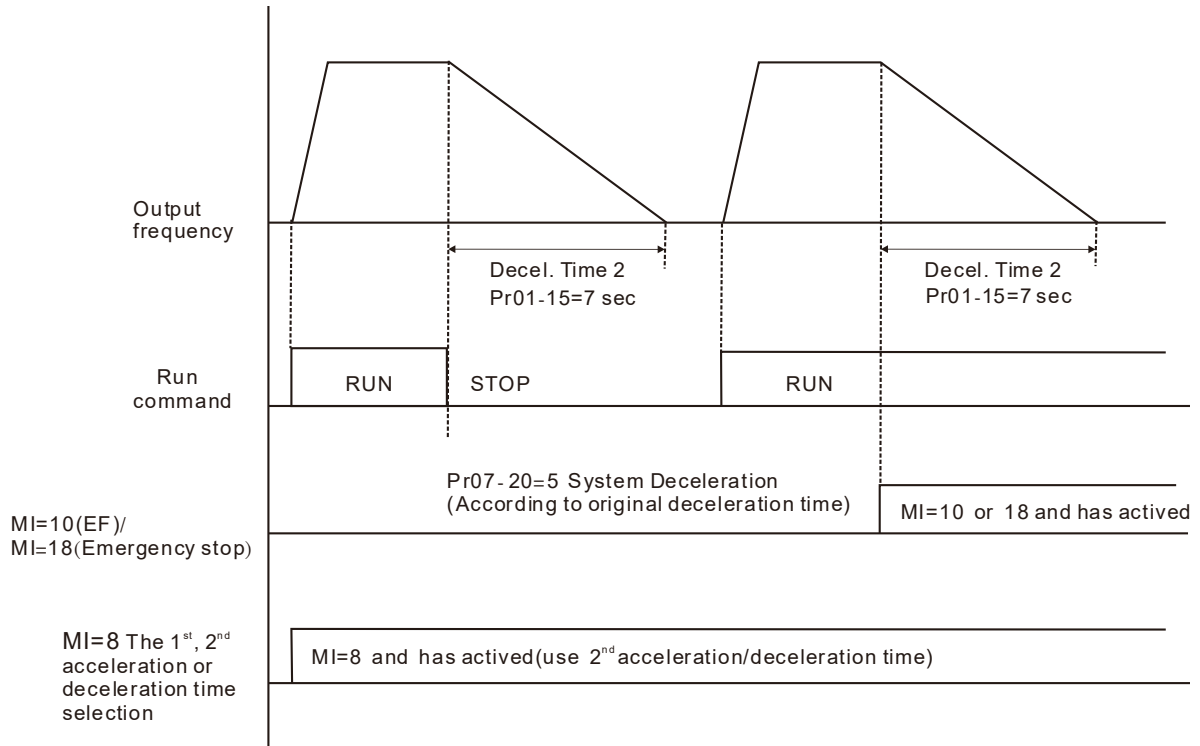

07-21 Auto Energy-saving Operation

Factory Setting: 0

Settings 0: Disable
1: Enable

- When Pr.07-21 is set to 1, the acceleration and deceleration will operate with full voltage. During constant speed operation, it will auto calculate the best voltage value by the load power for the load. This function is not suitable for the ever-changing load or near full-load during operation.
- When the output frequency is constant, i.e. constant operation, the output voltage will auto decrease by the load reduction. Therefore, the drive will operate with min. power, multiplication of voltage and current.

07-22 Energy-saving Gain

Factory Setting: 100





Settings 10~1000%

- When Pr. 07-21 is set to 1, this parameter can be used to adjust the gain of energy-saving. The factory setting is 100%. If the result is not good, it can adjust by decreasing the setting. If the motor oscillates, it should increase the setting value.
- In some applications, such as: high-speed spindle. Pay more attention to the temperature of the motor, it is hoped that the motor current can be reduced to a lower motor current level when the motor in the non-working state. Turn down this parameter can achieve the requirement.

07-23 Auto Voltage Regulation(AVR) Function

Factory Setting: 0

Settings 0: Enable AVR
1: Disable AVR
2: Disable AVR during deceleration

-  Setting 0: when AVR function is enabled, the drive will calculate the output voltage by actual DC-bus voltage. The output voltage won't be changed by DC bus voltage.
-  Setting 1: when AVR function is disabled, the drive will calculate the output voltage by DC-bus voltage. The output voltage will be changed by DC bus voltage. It may cause insufficient/over current.
-  Setting 2: the drive will disable the AVR during deceleration, such as operated from high speed to low speed.
-  When the motor ramps to stop, the deceleration time is longer. When setting this parameter to 2 with auto acceleration/deceleration, the deceleration will be quicker.

07-24 Filter Time of Torque Command (V/F and SVC control mode)

Factory Setting: 0.500



Settings 0.001~10.000 sec

-  When the setting is too long, the control will be stable but the control response will be delay. When the setting is too short, the response will be quickly but the control may be unstable. User can adjust the setting by the control and response situation.

07-25 Filter Time of Slip Compensation (V/F and SVC control mode)

Factory Setting: 0.100

Settings 0.001~10.000 sec



-  It can set Pr.07-24 and 07-25 to change the response time of compensation.
-  If Pr.07-24 and 07-25 are set to 10seconds, the response time of compensation is the slowest. But the system may be unstable when the setting is too short.

07-26 Torque Compensation Gain (V/F and SVC control mode)

Factory Setting: 0

Settings Induction Motor 0~10 (Pr.05-33=0)

PMSM: 0~5000 (Pr.05-33=1 or 2)

-  When the motor load is large, a part of drive output voltage is absorbed by the resistor of stator winding and causes insufficient voltage at motor induction and result in over output current and insufficient output torque. It can auto adjust output voltage by the load and keep the air gap magnetic fields stable to get the optimal operation.
-  In the V/F control, the voltage will be decreased in direct proportion when the frequency is decreased. It'll cause decrease torque at low speed due to small AC resistor and the same DC resistor. Therefore, Auto torque compensation function will increase the output voltage in the low frequency to get higher start torque.
-  When Pr.07-26 is set too large, it may cause motor overflux and result in too large output current, motor overheat or triggers protection function.

07-27 Slip Compensation Gain (V/F and SVC control mode)

Factory Setting: 0.00

(1 in SVC mode)

Settings 0.00~10.00

-  The induction motor needs the constant slip to produce magnetic torque. It can be ignore in the

higher motor speed, such as rated speed or 2~3% slip.

- 📖 In the operation with variable frequency, the slip and the synchronous frequency will be in reverse proportion to produce the same magnetic torque. That is the slip will be larger with the reduction of synchronous frequency. The motor may stop when the synchronous frequency is decreased to a specific value. Therefore, the slip seriously affects the accuracy of motor speed at low speed.
- 📖 In another situation, when the drive uses with induction motor, the slip will be increased by the increasing load. It also affects the accuracy of motor speed.
- 📖 This parameter can be used to set compensation frequency and reduce the slip to close the synchronous speed when the motor runs in the rated current to raise the drive accuracy. When the drive output current is larger than Pr.05-05 No-load Current of Induction Motor 1 (A), the drive will compensate the frequency by this parameter.
- 📖 When the control method (Pr.00-11) is changed from V/f mode to vector mode, this parameter will auto be set to 1.00. Otherwise, it will be set to 0.00. Please do the compensation of slip after overload and acceleration. The compensation value should be increased from small to large gradually. That is to add the output frequency with motor rated slip X Pr.07-27 Slip Compensation Gain when the motor is rated load. If the actual speed ratio is slow than expectation, please increase the setting. Otherwise, decrease the setting.

↗ **07-29** Slip Deviation Level Factory Setting: 0

Settings 0~100.0%

0: No detection

↗ **07-30** Detection Time of Slip Deviation Factory Setting:1.0

Settings 0.0~10.0 sec

↗ **07-31** Over Slip Treatment Factory Setting:0

Settings 0: Warn and keep operation

1: Warn and ramp to stop

2: Warn and coast to stop

3: No warning

📖 The Pr.07-29 to Pr.07-31 is to set allowable slip level/time and over slip treatment when the drive is running.

↗ **07-32** Motor Hunting Gain Factory Setting:1000

Settings 0~10000

0: Disable

📖 The motor will have current wave motion in some specific area. It can improve this situation by setting this parameter. (When it is high frequency, it can be set to 0. When the current wave motion happens in the low frequency, please increase Pr.07-32.)

07-33 Auto restart interval of Fault

Factory Setting:60.0

Settings 0.0~6000.0 sec

-  When a reset/restart after fault occurs, the drive will regards Pr.07-33 as a time boundary and begin counting the numbers of faults occur within this time period. Within the period, if numbers of faults occurred did not exceed the setting in Pr.07-11, the counting will be cleared and starts from 0 when next fault occurs. However, if the numbers of faults occurred within this time period have exceed the setting in Pr.07-11, user will need to press RESET key manually for the drive to operate again.

08 High-function PID Parameters

✎ This parameter can be set during operation.

✎ 08-00 Input Terminal for PID Feedback

Factory Setting:0

Settings 0: No function

1: Negative PID feedback: input from external terminal AVI1 (Pr.03-00)

4: Positive PID feedback from external terminal AVI1 (Pr.03-00)

- 📖 Negative feedback means: +target value – feedback. It is used for the detection, value will be increased by increasing the output frequency.
- 📖 Positive feedback means: -target value + feedback. It is used for the detection, value will be decreased by increasing the output frequency.
- 📖 When Pr.08-00≠7 neither ≠8, input value is disabled. The value of the setting remains the same after the drive is off.

Common applications for PID control

1. Flow control: A flow sensor is used to feedback the flow data and performs accurate flow control.
2. Pressure control: A pressure sensor is used to feedback the pressure data and performs precise pressure control.
3. Air volume control: An air volume sensor is used to feedback the air volume data to have excellent air volume regulation.
4. Temperature control: A thermocouple or thermistor is used to feedback temperature data for comfortable temperature control.
5. Speed control: A speed sensor or encoder is used to feedback motor shaft speed or input another machines speed as a target value for closed loop speed control of master-slave operation. Pr.10.00 sets the PID set point source (target value).

📖 PID control loop:

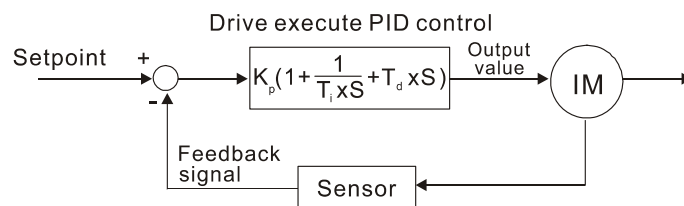

K_p : Proportional gain(P) T_i : Integral time(I) T_d : Derivative control(D) S: Operator

📖 Concept of PID control

1. Proportional gain(P):
The output is proportional to input. With only proportional gain control, there will always be a steady-state error.
2. Integral time(I):
The controller output is proportional to the integral of the controller input. To eliminate the steady-state error, an “integral part” needs to be added to the controller. The integral time decides the relation between integral part and error. The integral part will be increased by time even if the error is small. It gradually increases the controller output to eliminate the

error until it is 0. In this way, a system can be stable without steady-state error by proportional gain control and integral time control.

3. Differential control(D):

The controller output is proportional to the differential of the controller input. During elimination of the error, oscillation or instability may occur. The differential control can be used to suppress these effects by acting before the error. That is, when the error is near 0, the differential control should be 0. Proportional gain (P) + differential control (D) can be used to improve the system state during PID adjustment.

 When PID control is used in a constant pressure pump feedback application:

Set the application's constant pressure value (bar) to be the set point of PID control. The pressure sensor will send the actual value as PID feedback value. After comparing the PID set point and PID feedback, there will be an error. Thus, the PID controller needs to calculate the output by using proportional gain (P), integral time (I) and differential time (D) to control the pump. It controls the drive to have different pump speed and achieves constant pressure control by using a 4~20mA signal corresponding to 0~10 bar as feedback to the drive.

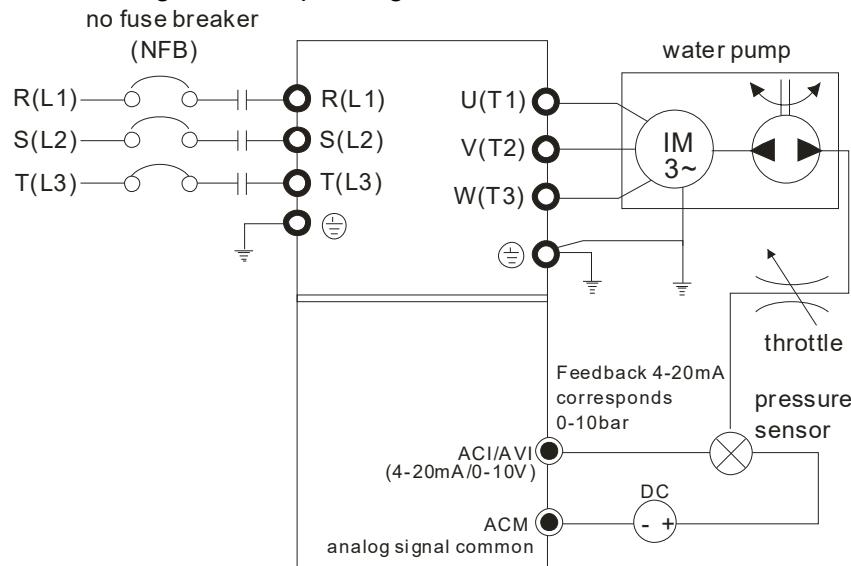

1. Pr.00-04 is set to 10 (Display PID analog feedback signal value (b) (%))
2. Pr.01-12 Acceleration Time will be set as required
3. Pr.01-13 Deceleration Time will be set as required
4. Pr.00-21=0 to operate from the digital keypad
5. Pr.00-20=0, the set point is controlled by the digital keypad
6. Pr.08-00=1 (Negative PID feedback from analog input)
7. ACI analog input Pr. 03-01 set to 5, PID feedback signal.
8. Pr.08-01~08-03 will be set as required
 - 8.1 If there is no vibration in the system, increase Pr.08-01(Proportional Gain (P))
 - 8.2 If there is no vibration in the system, reduce Pr.08-02(Integral Time (I))
 - 8.3 If there is no vibration in the system, increase Pr.08-03(Differential Time (D))

 Refer to Pr.08-00 to 08-21 for PID parameters settings.

 **08-01** Proportional Gain (P)

Factory Setting:1.0

Settings 0.0~100.0%

 When the setting is 1.0, it means Kp gain is 100%; setting is 0.5, means Kp gain is 50%.

 It is used to eliminate the system error. It is usually used to decrease the error and get the faster

response speed. But if the value is set too high, it may cause the system oscillation and instability.

 If the other two gains (I and D) are set to zero, proportional control is the only one effective.

 **08-02** Integral Time (I)

Factory Setting:1.00

Settings 0.00~100.00 sec

 The integral controller is used to eliminate the error during stable system. The integral control doesn't stop working until error is 0. The integral is acted by the integral time. The smaller integral time is set, the stronger integral action will be. It is helpful to reduce overshoot and oscillation to make a stable system. At this moment, the decreasing error will be slow. The integral control is often used with other two controls to become PI controller or PID controller.

 This parameter is used to set the integral time of I controller. When the integral time is long, it will have small gain of I controller, the slower response and bad external control. When the integral time is short, it will have large gain of I controller, the faster response and rapid external control.

 When the integral time is too small, it may cause system oscillation.

 If the integral time is set as 0.00, Pr.08-02 will be disabled.

 **08-03** Derivative Control (D)

Factory Setting:0.00

Settings 0.00~1.00 sec

 The differential controller is used to show the change of system error and it is helpful to preview the change of error. So the differential controller can be used to eliminate the error to improve system state. With the suitable differential time, it can reduce overshoot and shorten adjustment time. However, the differential operation will increase the noise interference. Please note that too large differential will cause big noise interference. Besides, the differential shows the change and the output of the differential will be 0 when there is no change. Therefore, the differential control can't be used independently. It needs to be used with other two controllers to make a PD controller or PID controller.

 This parameter can be used to set the gain of D controller to decide the response of error change. The suitable differential time can reduce the overshoot of P and I controller to decrease the oscillation and have a stable system. But too long differential time may cause system oscillation.

 The differential controller acts for the change of error and can't reduce the interference. It is not recommended to use this function in the serious interference.

 **08-04** Upper limit of Integral Control

Factory Setting:100.0

Settings 0.0~100.0%

 This parameter defines an upper bound or limit for the integral gain (I) and therefore limits the Master Frequency. The formula is: Integral upper bound = Maximum Output Frequency (Pr.01-00) x (Pr.08-04 %).

 Too large integral value will make the slow response due to sudden load change. In this way, it may cause motor stall or machine damage.

- ↗ **08-05** PID Output Frequency Limit Factory Setting: 100.0
 Settings 0.0~110.0%
 ⓘ This parameter defines the percentage of output frequency limit during the PID control. The formula is Output Frequency Limit = Maximum Output Frequency (Pr.01-00) X Pr.08-05 %.
- ↗ **08-06** PID feedback value by communication protocol Factory Setting: Read only
 Settings -200.00%~200.00%
 ⓘ This parameter shows current PID feedback value.
- ↗ **08-07** PID Delay Time Factory Setting: 0.0
 Settings 0.0~35.0 sec
- ↗ **08-08** Feedback Signal Detection Time Factory Setting: 0.0
 Settings 0.0~3600.0 sec
 ⓘ Pr.08-08 is valid only for ACI 4~20mA.
 ⓘ This parameter sets the detection time of abnormal PID feedback. If detection time is set to 0.0, detection function is disabled.
- ↗ **08-09** Feedback Signal Fault Treatment Factory Setting: 0
 Settings 0: Warn and keep operation
 1: Warn and ramp to stop
 2: Warn and coast to stop
 3: Warn and operate at last frequency
 ⓘ This parameter is valid only for ACI 4~20mA.
 ⓘ AC motor drive acts when the feedback signals analog PID feedback is abnormal.
- ↗ **08-10** Sleep Reference Factory Setting: 0.00
 Settings 0.00~599.00Hz or 0~200.00%
 ⓘ Setting value of Pr.08-10 determines if sleep reference and wake-up reference is enable or disable. When Pr.08-10 = 0, it means disable. When 08-10 ≠ 0, it means enable.
- ↗ **08-11** Wake-up Reference Factory Setting: 0.00
 Settings 0.00~599.00Hz or 0~200.00%
 ⓘ When Pr.08-18 = 0, the unit of Pr.08-10 and that of Pr.08-11 become frequency. The settings then become 0.00~599.00 Hz.
 ⓘ When Pr.08-18=1, the unit of Pr.08-10 and that of Pr.08-11 switch to percentage. The settings then switch to 0~200.00%.

📖 And the percentage is based on the input command not maximum. E.g. If the maximum is 100 kg, the command now is 30kg, if 08-11=40%, the value is 12kg.

📖 It is the same as Pr.08-10.

↗ **08-12** Sleep Time

Factory Setting: 0.0

Settings 0.00~6000.0 sec

📖 When the frequency command is smaller than the sleep frequency and less than the sleep time, the frequency command is equal to the sleep frequency. However, the frequency command remains at 0.00Hz until the frequency command becomes equal to or bigger than the wake-up frequency.

↗ **08-13** PID Deviation Level

Factory Setting: 10.0

Settings 1.0~50.0%

↗ **08-14** PID Feedback Deviation Examine Time

Factory Setting: 5.0

Settings 0.1~300.0 sec

📖 PID controller should operate and approach the reference target value in a certain period of time when functions operate normally.

📖 Refer to PID control block diagram, if (PID reference target value - detection value) > Pr08-13 PID feedback deviation set value and the duration exceeds Pr08-14 set value under PID feedback control, the PID feedback control is fault and the multi-function output terminal option MO = 15 PID feedback deviation will be activated.

↗ **08-15** Filter Time for PID Feedback

Factory Setting: 5.0

Settings 0.1~300.0 sec

↗ **08-16** PID Compensation Selection

Factory Setting: 0

Settings 0: Parameter setting (Pr.08-17)

1: Analog input

📖 Pr.08-16=0: PID compensation value is given via Pr08-17 setting.

📖 Pr.08-16=1: The PID compensation value is given via analog input (Pr.03-00~03-02=13) and display at Pr.08-17(at this moment, Pr08-17 become read only).

↗ **08-17** PID Compensation

Factory Setting: 0



Settings -100.0~100.0%

📖 The PID compensation value=Max. PID target value×Pr08-17. For example, the max. output frequency Pr.01-00=60Hz, Pr.08-17=10.0%, PID compensation value will increase output frequency 6.00Hz. $60.00\text{Hz} \times 100.00\% \times 10.0\% = 6.00\text{Hz}$

08-18 Setting of Sleep Mode Function

Factory Setting: 0



Settings 0: Follow PID output command
1: Follow PID feedback signal

-  When Pr.08-18=0, the unit of Pr08-10 and that of Pr.08-11 becomes frequency. The settings then become 0.00~599.00Hz.
-  When Pr.08-18=1, the unit of Pr08-10 and that of Pr.08-11 switches to percentage. The settings then switch to 0~200.00%.

08-19 Wake-up Integral Limit

Factory Setting: 50.0







Settings 0.0~200.0%

-  The wake-up integral limit of the VFD is to prevent sudden high speed running when the VFD wakes up. The wake-up integral frequency limit=(01-00×08-19%)
-  The Pr.08-19 is used to reduce the reaction time from sleep to wake-up.

08-20 PID Mode Selection

Factory Setting: 0

Settings 0: Serial connection
1: Parallel connection

-  When setting is 0, it uses conventional PID control structure.
When setting is 1, proportional gain, integral gain and derivative gain are independent. The P, I and D can be customized to fit users' demand.
-  Pr.08-20 determines the primary low pass filter time when in PID control. Setting a large time constant may slow down the response rate of drive.
-  Output frequency of PID control will filter by primary low pass function. This function could filter mix frequencies. A long primary low pass time means filter degree is high and vice versa.
-  Inappropriate setting of delay time may cause system error.
-  PI Control: controlled by the P action only, and thus, the deviation cannot be eliminated entirely. To eliminate residual deviations, the P + I control will generally be utilized. And when the PI control is utilized, it could eliminate the deviation incurred by the targeted value changes and the constant external interferences. However, if the I action is excessively powerful, it will delay the responding toward the swift variation. The P action could be used solely on the loading system that possesses the integral components.
-  PD Control: when deviation occurred, the system will immediately generate some operation load that is greater than the load generated single handedly by the D action to restrain the increment of the deviation. If the deviation is small, the effectiveness of the P action will be decreasing as well. The control objects include occasions with integral component loads, which are controlled by the P action only, and sometimes, if the integral component is functioning, the whole system will be vibrating. On such occasions, in order to make the P action's vibration subsiding and the system stabilizing, the PD control could be utilized. In other words, this control is good for use with loadings of no brake functions over the processes.

- PID Control:** Utilize the I action to eliminate the deviation and the D action to restrain the vibration, thereafter, combine with the P action to construct the PID control. Use of the PID method could obtain a control process with no deviations, high accuracies and a stable system.
- Serial connection**

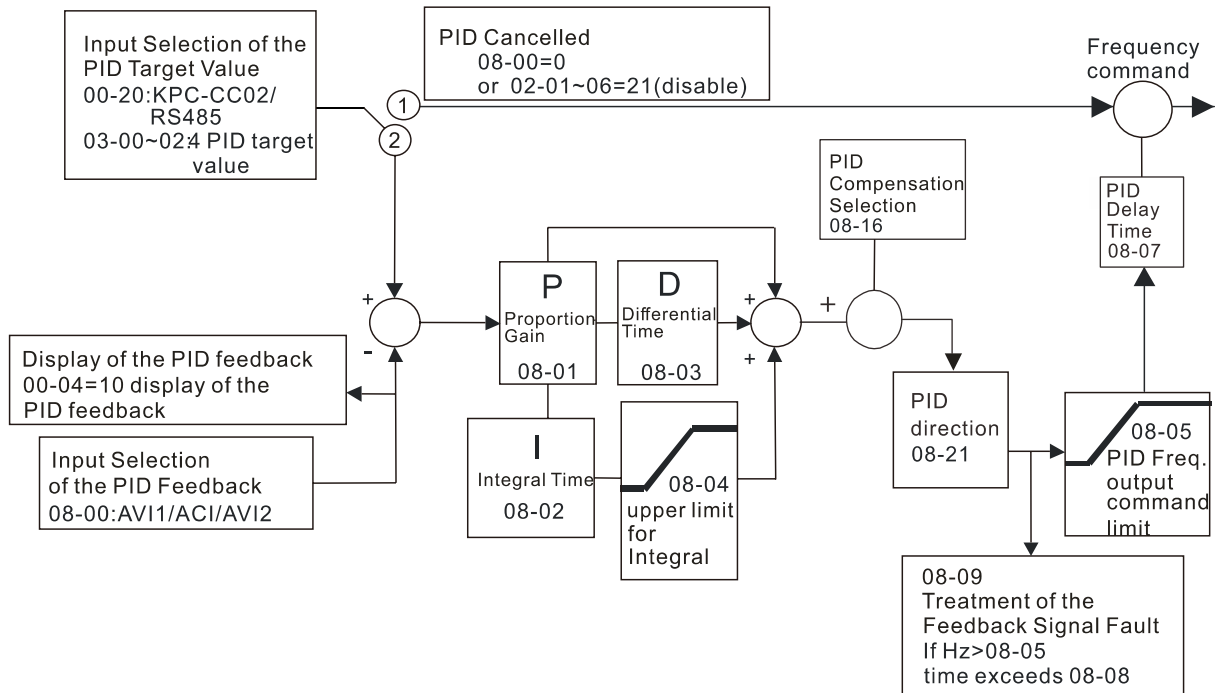

Parallel connection

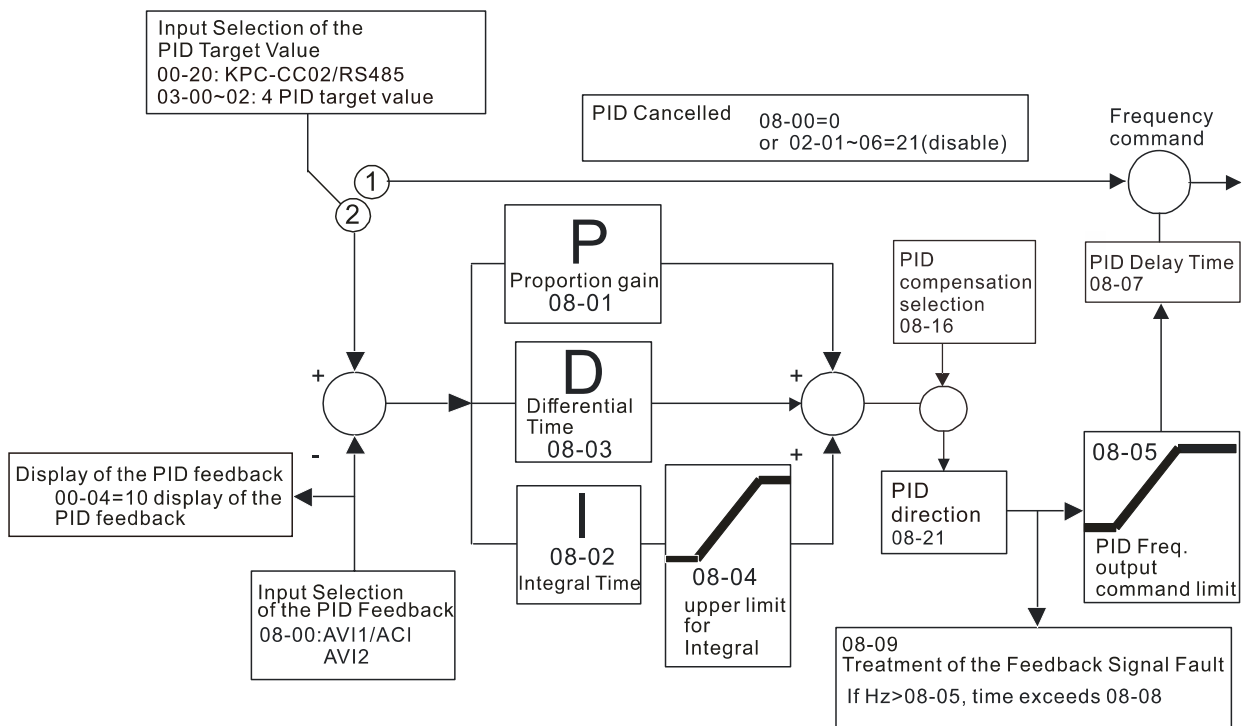

08-21 Enable PID to Change the Operation Direction

Factory Setting: 0

- Settings 0: Disable change of direction
- 1: Enable change of direction

08-22 Wake-up delay time

Factory Setting: 0.00

Settings 0.00~600.00 sec.

Refer to Pr.08-18 for more information.

There are three scenarios for sleep and wake-up frequency.

1) Frequency Command (PID is not in use, Pr.08=00. Only works in VF mode)

When the frequency command is less than the sleep frequency, the output frequency will be at the sleep frequency. When the time reaches the sleep time which set by Pr08-12, the motor will go to sleep at 0Hz.

Sleep Mode Diagram

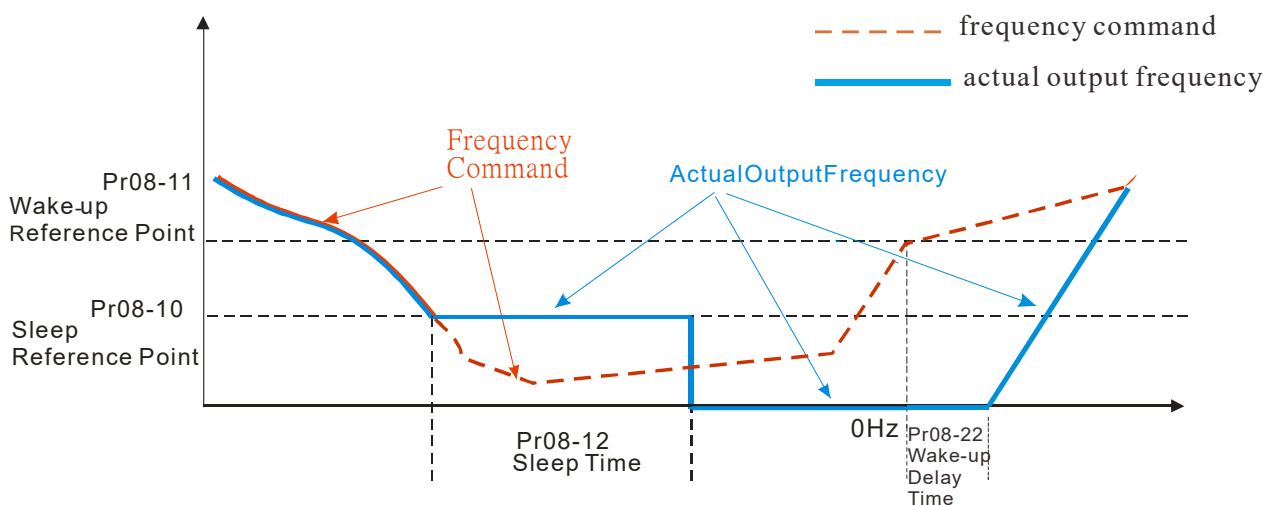

2) Frequency Command Calculation of the Internal PID (PID is in use, Pr.08-00 ≠ 0)

After the sleep frequency is reached, the system will begin to calculate the sleep time and the output frequency will drop immediately according to the setting of Pr01-13(1st deceleration time). If the deceleration time exceeds the preset sleep time, the frequency will continue to drop to 0Hz and the motor will go to sleep at 0Hz.

If the deceleration time (if there is a preset) does not reach the preset sleep time, the motor will remain at Pr01-11 (Lower Frequency) or remain at Pr01-07 (Output the lowest frequency setting), the motor will wait for the sleep time and go to sleep at 0Hz.

Internal PID Calculation Frequency Command

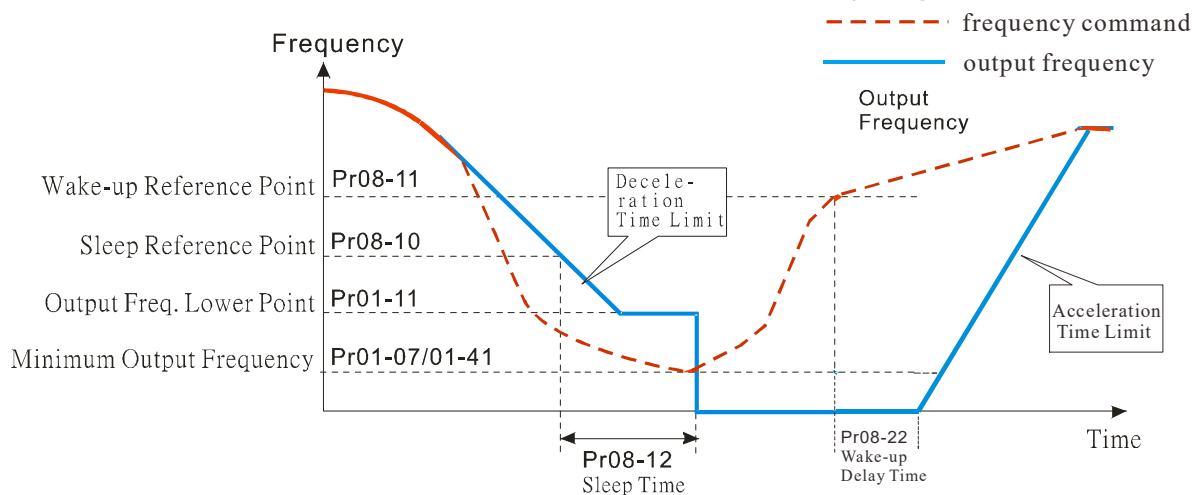

3) PID Target Percentage (Use PID, Pr.08-00 ≠ 0)

After reaching the PID target percentage and the feedback value percentage, the motor will start to calculate the sleep time. The output frequency will drop immediately after setting the first deceleration time of Pr01-13. If the motor has exceeded the preset sleep time, it will go to sleep at 0Hz.

However, if the deceleration time does not reach the preset sleep time, it will remain at the lower limit (if preset Pr01-11) or remain at the lowest output frequency of Pr01-07, then wait for the sleep time and go to sleep at 0Hz.

Example 01: PID negative feedback

- Pr08-10 must > Pr08-11
- 30kg is the reference
- Set the parameter:
 Pr03-00=5 (AV11 is PID feedback)
 Pr 08-00=1 (PID negative feedback: AV11 simulation input function select)
 Pr 08-10=40% (Sleep reference: 12kg=40%*30kg)
 Pr 08-11=20% (Wake-up reference: 6kg=20%*30kg)

Area	PID Physical quantity
Sleep area	>12kg, motor goes into sleep
Excessive area	between 6kg and 12kg, motor remains in the current state
Wake-up area	<6kg, motor wakes-up

Case 01: If feedback >12kg, frequency decrease.

Case 02: If feedback <6kg, frequency increase.

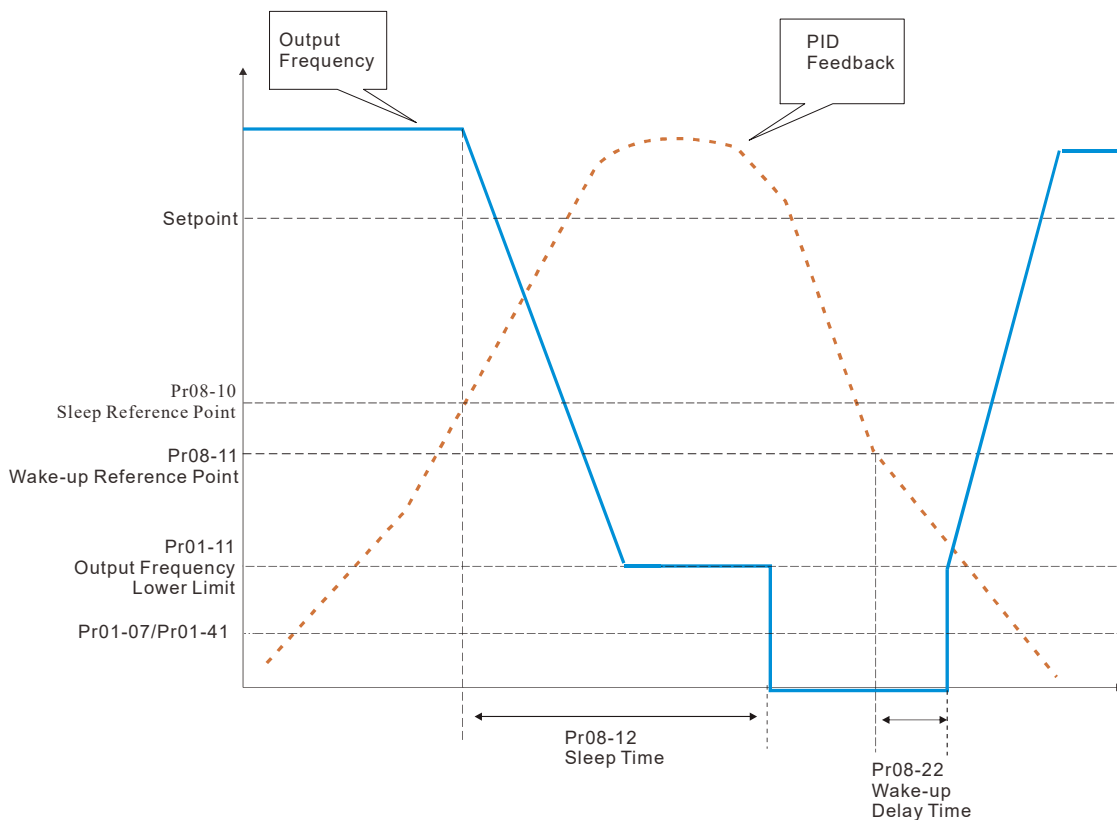

Example 02: PID positive feedback

- Pr08-10 must < Pr08-11
- 30kg is the reference
- Set the parameter:
 Pr03-00=5 (AVI1 is PID feedback)
 Pr 08-00=4 (PID positive feedback: AVI1 simulation input function select)
 Pr 08-10=110% (Sleep reference: $33\text{kg}=110\%*30\text{kg}$)
 Pr 08-11=120% (Wake-up reference: $36\text{kg}=120\%*30\text{kg}$)

Area	PID Physical quantity
Sleep area	>36kg, motor goes into sleep
Excessive area	between 33kg and 36kg, motor remains in the current state
Wake-up area	<33kg, motor wakes-up

Case 01: If feedback <33kg, frequency decrease.

Case 02: If feedback >36kg, frequency increase.

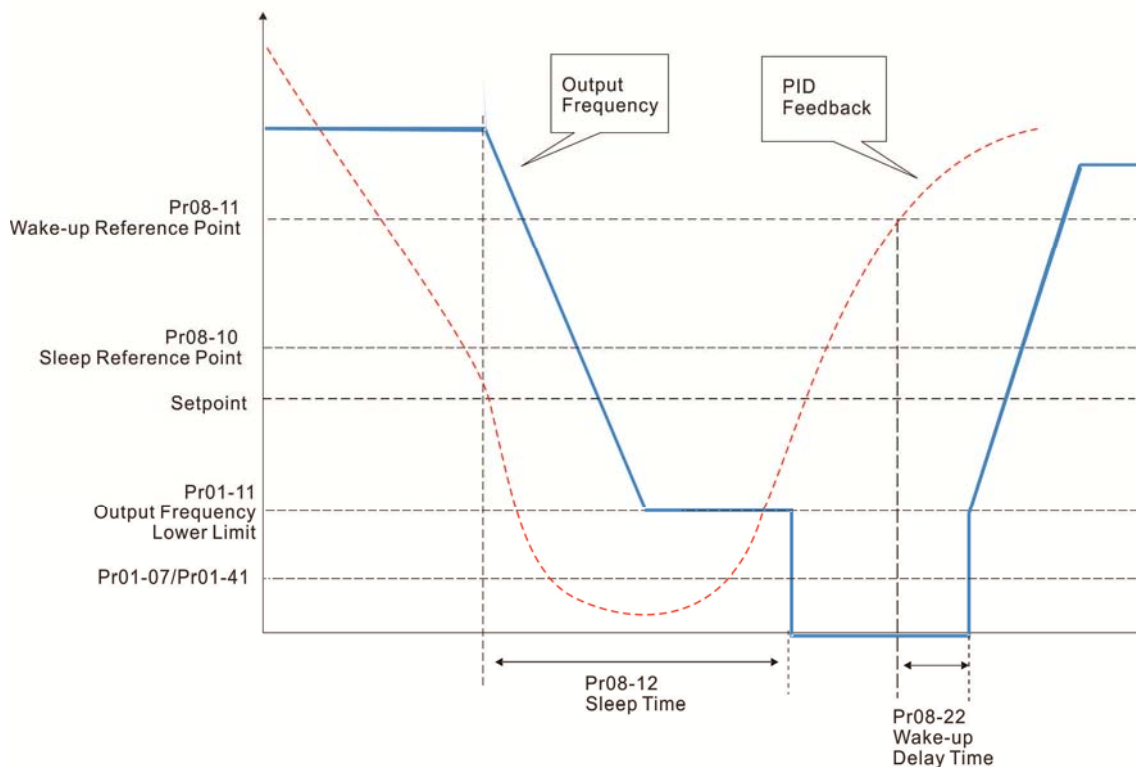

09 Communication Parameters

↗ The parameter can be set during the operation.

When using communication devices, connects AC drive with PC by using Delta IFD6530 or IFD6500.

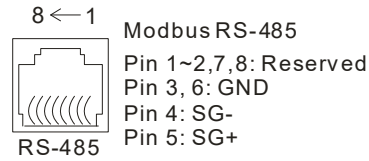

↗ 09-00 COM1 Communication Address

Factory Setting: 1

Settings 1~254

- 📖 If the AC motor drive is controlled by RS-485 serial communication, the communication address for this drive must be set via this parameter and each AC motor drive's communication address must be different.

↗ 09-01 COM1 Transmission Speed

Factory Setting: 9.6

Settings 4.8~115.2Kbps

- 📖 This parameter is for set up the RS485 communication transmission speed.
- 📖 Please set 4.8Kbps, 9.6Kbps, 19.2Kbps, 38.4Kbps, 57.6Kbps and 115.2Kbps. If the value is not including in the 6 type that mentioned, it will be replaced by 9.6Kbps.

↗ 09-02 COM1 Transmission Fault Treatment

Factory Setting: 3

Settings 0: Warn and keep operation
 1: Warn and ramp to stop
 2: Warn and coast to stop
 3: No warning and continue operation

- 📖 This parameter is to set the reaction of MODBUS transmission errors with the host. Detection time can be set in Pr09-03.

↗ 09-03 COM1 Time-out Detection

Factory Setting: 0.0

Settings 0.0~100.0 sec



- 📖 It is used to set the communication transmission time-out.

↗ 09-04 COM1 Communication Protocol

Factory Setting: 1

Settings 1: 7, N, 2 for ASCII
 2: 7, E, 1 for ASCII
 3: 7, O, 1 for ASCII
 4: 7, E, 2 for ASCII
 5: 7, O, 2 for ASCII
 6: 8, N, 1 for ASCII
 7: 8, N, 2 for ASCII

- 8: 8, E, 1 for ASCII
- 9: 8, O, 1 for ASCII
- 10: 8, E, 2 for ASCII
- 11: 8, O, 2 for ASCII
- 12: 8, N, 1 for RTU
- 13: 8, N, 2 for RTU
- 14: 8, E, 1 for RTU
- 15: 8, O, 1 for RTU
- 16: 8, E, 2 for RTU
- 17: 8, O, 2 for RTU

-  Control by PC or PLC (Computer Link)
-  A VFD-CFP2000 can be set up to communicate on Modbus networks using one of the following modes: ASCII (American Standard Code for Information Interchange) or RTU (Remote Terminal Unit).Users can select the desired mode along with the RS-485 serial port communication protocol in Pr.09-00.
-  MODBUS ASCII (American Standard Code for Information Interchange) : Each byte data is the combination of two ASCII characters. For example, a 1-byte data: 64 Hex, shown as '64' in ASCII, consists of '6' (36Hex) and '4' (34Hex).

1. Code Description

Communication protocol is in hexadecimal, ASCII: "0", "9", "A", "F", every 16 hexadecimal represents ASCII code. For example:

Character	'0'	'1'	'2'	'3'	'4'	'5'	'6'	'7'
ASCII code	30H	31H	32H	33H	34H	35H	36H	37H

Character	'8'	'9'	'A'	'B'	'C'	'D'	'E'	'F'
ASCII code	38H	39H	41H	42H	43H	44H	45H	46H

2. Data Format

10-bit character frame (For ASCII):

(7 , N , 2)

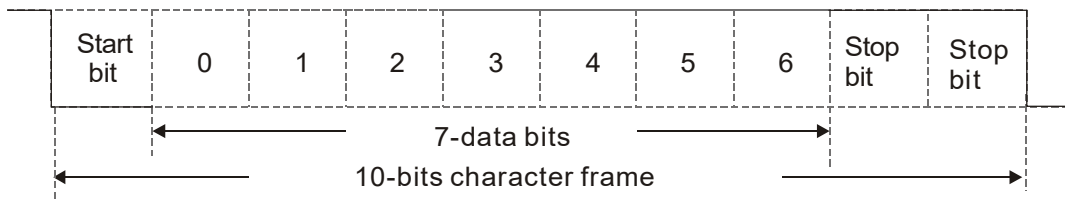

(7 , E , 1)

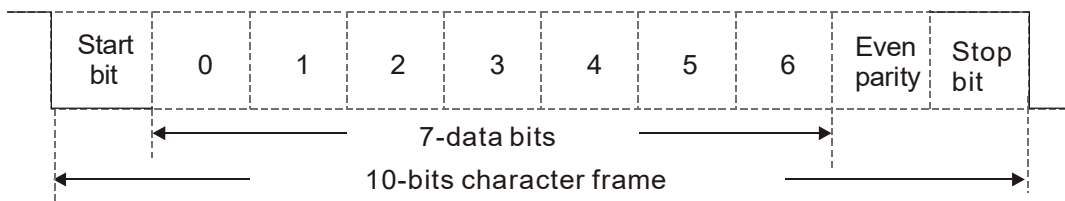

(7, O, 1)

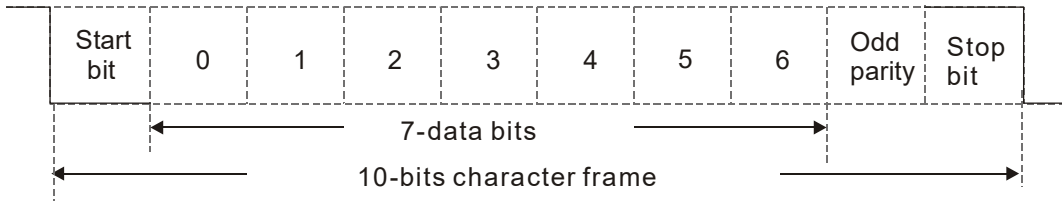

11-bit character frame (For RTU):

(8, N, 2)

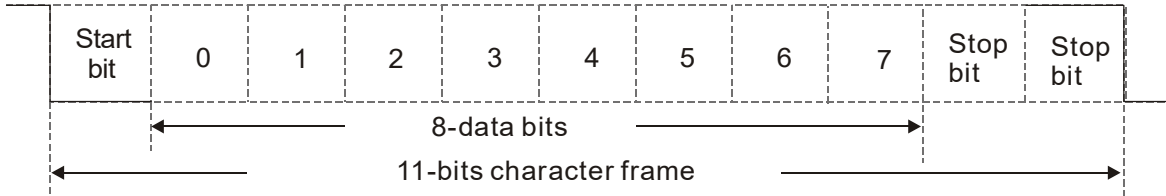

(8, E, 1)

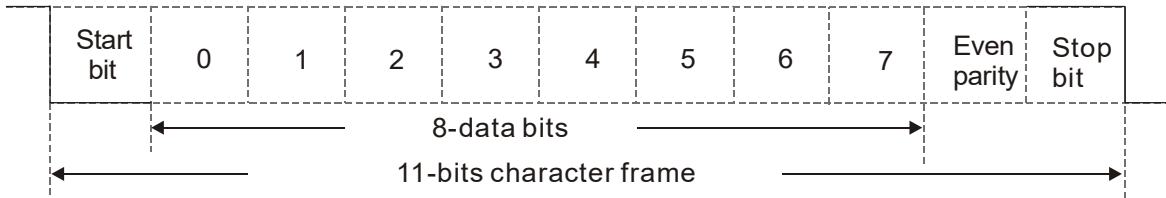

(8, O, 1)

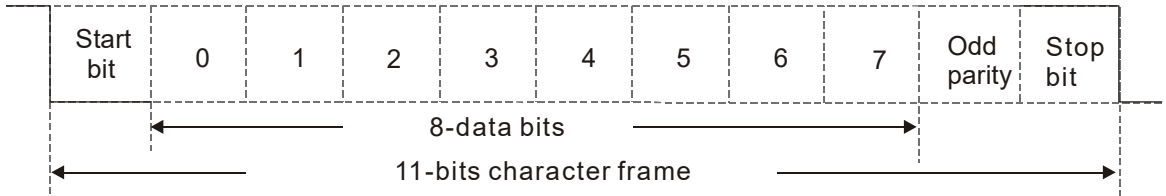

3. Communication Protocol

Communication Data Frame: **ASCII mode**

STX	Start character = ':' (3AH)
Address Hi	Communication address: 8-bit address consists of 2 ASCII codes
Address Lo	
Function Hi	Command code: 8-bit command consists of 2 ASCII codes
Function Lo	
DATA (n-1)	Contents of data: Nx8-bit data consist of 2n ASCII codes n<=16, maximum of 32 ASCII codes
.....	
DATA 0	
LRC CHK Hi	LRC check sum: 8-bit check sum consists of 2 ASCII codes
LRC CHK Lo	
END Hi	End characters: END1= CR (0DH), END0= LF(0AH)
END Lo	

Communication Data Frame: **RTU** mode

START	A silent interval of more than 10 ms
Address	Communication address: 8-bit address
Function	Command code: 8-bit command
DATA (n-1)	Contents of data: n×8-bit data, n≤16
.....	
DATA 0	
CRC CHK Low	CRC check sum: 16-bit check sum consists of 2 8-bit characters
CRC CHK High	
END	A silent interval of more than 10 ms

Address (Communication Address)

Valid communication addresses are in the range of 0 to 254. A communication address equal to 0, means broadcast to all AC drives (AMD). In this case, the AMD will not reply any message to the master device.

00H: broadcast to all AC drives

01H: AC drive of address 01

0FH: AC drive of address 15

10H: AC drive of address 16

:

FEH: AC drive of address 254

Function (Function code) and DATA (data characters)

The format of data characters depends on the function code.

03H: read data from register

06H: write single register

10H: write continuous multiple data

Example: reading continuous 2 data from register address 2102H, AMD address is 01H.

ASCII mode:

Command Message:		Response Message	
STX	‘.’	STX	‘.’
Address	‘0’	Address	‘0’
	‘1’		‘1’
Function	‘0’	Function	‘0’
	‘3’		‘3’
Starting register	‘2’	Number of register (count by byte)	‘0’
	‘1’		‘4’
	‘0’	Content of starting register 2102H	‘1’
	‘2’		‘7’
Number of register (count by word)	‘0’	Content of register 2103H	‘7’
	‘0’		‘0’
	‘0’		‘0’
	‘2’		‘0’
LRC Check	‘D’	LRC Check	‘0’
	‘7’		‘7’
END	CR	END	‘1’
	LF		CR
			LF

RTU mode:

Command Message:		Response Message	
Address	01H	Address	01H
Function	03H	Function	03H
Starting data register	21H	Number of register (count by byte)	04H
	02H		
Number of register (count by word)	00H	Content of register address 2102H	17H 70H
	02H	Content of register address 2103H	00H 00H
CRC CHK Low	6FH	CRC CHK Low	FEH
CRC CHK High	F7H	CRC CHK High	5CH

06H: single write, write single data to register.

Example: writing data 6000(1770H) to register 0100H. AMD address is 01H.

ASCII mode:

Command Message:		Response Message	
STX	‘.’	STX	‘.’
Address	‘0’	Address	‘0’
	‘1’		‘1’
Function	‘0’	Function	‘0’
	‘6’		‘6’
Target register	‘0’	Target register	‘0’
	‘1’		‘1’
	‘0’		‘0’
	‘0’		‘0’
Register content	‘1’	Register content	‘1’
	‘7’		‘7’
	‘7’		‘7’
	‘0’		‘0’
LRC Check	‘7’	LRC Check	‘7’
	‘1’		‘1’
END	CR	END	CR
	LF		LF

RTU mode:

Command Message:		Response Message	
Address	01H	Address	01H
Function	06H	Function	06H
Target register	01H	Target register	01H
	00H		00H
Register content	17H	Register content	17H
	70H		70H
CRC CHK Low	86H	CRC CHK Low	86H
CRC CHK High	22H	CRC CHK High	22H

10H: write multiple registers (write multiple data to registers) (at most 20 sets of data can be written simultaneously)

Example: Set the multi-step speed,

Pr.04-00=50.00 (1388H), Pr.04-01=40.00 (0FA0H). AC drive address is 01H.

ASCII Mode

Command Message:		Response Message	
STX	‘.’	STX	‘.’
ADR 1	‘0’	ADR 1	‘0’
ADR 0	‘1’	ADR 0	‘1’
CMD 1	‘1’	CMD 1	‘1’

Command Message:		Response Message	
CMD 0	'0'	CMD 0	'0'
Target register	'0'	Target register	'0'
	'4'		'4'
	'0'		'0'
	'0'		'0'
Number of register (count by word)	'0'	Number of register (count by word)	'0'
	'0'		'0'
	'0'		'0'
	'2'		'2'
Number of register (count by Byte)	'0'	LRC Check	'E'
	'4'		'8'
The first data content	'1'	END	CR
	'3'		LF
	'8'		
	'8'		
The second data content	'0'		
	'F'		
	'A'		
	'0'		
LRC Check	'9'		
	'B'		
END	CR		
	LF		

RTU mode:

Command Message:		Response Message:	
ADR	01H	ADR	01H
CMD	10H	CMD 1	10H
Target register	04H	Target register	04H
	00H		00H
Number of register (Count by word)	00H	Number of register (Count by word)	00H
	02H		02H
Quantity of data (Byte)	04	CRC Check Low	41H
The first data content	13H	CRC Check High	04H
	88H		
The second data content	0FH		
	A0H		
CRC Check Low	'9'		
CRC Check High	'A'		

Check sum

ASCII mode:

LRC (Longitudinal Redundancy Check) is calculated by summing up, module 256, and the values of the bytes from ADR1 to last data character then calculating the hexadecimal representation of the 2's-complement negation of the sum.

For example,

$01H+03H+21H+02H+00H+02H=29H$, the 2's-complement negation of 29H is **D7H**.

RTU mode:

CRC (Cyclical Redundancy Check) is calculated by the following steps:

Step 1:

Load a 16-bit register (called CRC register) with FFFFH.

Step 2:

Exclusive OR the first 8-bit byte of the command message with the low order byte of the 16-bit CRC register, putting the result in the CRC register.

Step 3:

Examine the LSB of CRC register.

Step 4:

If the LSB of CRC register is 0, shift the CRC register one bit to the right with MSB zero filling, then repeat step 3. If the LSB of CRC register is 1, shift the CRC register one bit to the right with MSB zero filling, Exclusive OR the CRC register with the polynomial value A001H, then repeat step 3.

Step 5:

Repeat step 3 and 4 until eight shifts have been performed. When this is done, a complete 8-bit byte will be processed.

Step 6:

Repeat step 2 to 5 for the next 8-bit byte of the command message. Continue doing this until all bytes have been processed. The final contents of the CRC register are the CRC value. When transmitting the CRC value in the message, the upper and lower bytes of the CRC value must be swapped, i.e. the lower order byte will be transmitted first.

The following is an example of CRC generation using C language. The function takes two arguments:

Unsigned char* data ← a pointer to the message buffer

Unsigned char length ← the quantity of bytes in the message buffer

The function returns the CRC value as a type of unsigned integer.

Unsigned int crc_chk (unsigned char* data, unsigned char length)

```

{
    int j;
    unsigned int reg_crc=0Xffff;
    while(length--){
        reg_crc ^= *data++;
        for(j=0;j<8;j++){
            if(reg_crc & 0x01){ /* LSB(b0)=1 */
                reg_crc=(reg_crc>>1) ^ 0Xa001;
            }else{
                reg_crc=reg_crc >>1;
            }
        }
    }
    return reg_crc;                // return register CRC
}

```

4. Address list

Content	Register	Function	
AC drive parameters	GGnnH	GG means parameter group, nn means parameter number, for example, the address of Pr 4-01 is 0401H.	
Command write only	2000H	Bit1~0	00B : No function
			01B : Stop
			10B : Run
			11B : JOG
		Bit3~2	Reserved
		Bit5~4	00B : No function
			01B : FWD
			10B : REV
			11B : Change direction
		Bit7~6	00B : 1st accel/decel.
			01B : 2nd accel/decel
			10B : 3rd accel/decel
			11B : 4th accel/decel
		Bit11~8	000B: master speed
			0001B: 1st Step Speed Frequency
			0010B: 2nd Step Speed Frequency
			0011B: 3rd Step Speed Frequency
			0100B: 4th Step Speed Frequency
			0101B: 5th Step Speed Frequency
			0110B: 6th Step Speed Frequency
			0111B: 7th Step Speed Frequency
			1000B: 8th Step Speed Frequency
			1001B: 9th Step Speed Frequency
			1010B: 10th Step Speed Frequency
			1011B: 11th Step Speed Frequency
			1100B: 12th Step Speed Frequency
			1101B: 13th Step Speed Frequency
1110B: 14th Step Speed Frequency			
1111B: 15th Step Speed Frequency			
Bit12	1: Enable bit06~11 function		
Bit14~13	00B : No function		
	01B : Operated by digital keypad		
	10B : Operated by Pr.00-21 setting		
	11B : Change operation source		
Bit15	Reserved		
2001H	Frequency command(XXX.XXHz)		
2002H	Bit0	1 : EF (external fault) on	
	Bit1	1 : Reset	
	Bit2	1 : B.B ON	
	Bit15~3	Reserved	
Status monitor read only	2100H	High byte: Warn Code Low Byte: Error Code	
	2101H	Bit1~0	AC Drive Operation Status 00B: Drive stops 01B: Drive decelerating 10B: Drive standby 11B: Drive operating
		Bit2	1 : JOG Command
		Bit4~3	Operation Direction 00B: FWD run

Content	Register	Function
		01B: From REV run to FWD run 10B: From FWD run to REV run 11B: REV run
	Bit8	1 : Master frequency controlled by communication interface
	Bit9	1 : Master frequency controlled by analog signal
	Bit10	1 : Operation command controlled by communication interface
	Bit11	1 : Parameter locked
	Bit12	1 : Enable to copy parameters from keypad
	Bit15~13	Reserved
	2102H	Frequency command (XXX.XX Hz)
	2103H	Output frequency (XXX.XX Hz)
	2104H	Output current (XX.XXA) . When current is higher than 655.35,it will shift decimal as (XXX.XA) . The decimal can refer to High byte of 211F.
	2105H	DC-BUS Voltage (XXX.XV)
	2106H	Output voltage (XXX.XV)
	2107H	Current step number of Multi-Step Speed Operation
	2108H	Reserved
	2109H	Counter value
	210AH	Power Factor Angle (XXX.X)
	210BH	Output Torque (XXX.X%)
	210CH	Actual motor speed (XXXXXrpm)
	210DH	Reserved
	210EH	Reserved
	210FH	Power output (X.XXX KWH)
	2116H	Multi-function display (Pr.00-04)
	211BH	Max. operation frequency (Pr.01-00) or Max. user defined value (Pr.00-26) When Pr00-26 is 0, this value is equal to Pr01-00 setting When Pr00-26 is not 0, and the command source is Keypad, this value = Pr00-24 * Pr00-26 / Pr01-00 When Pr00-26 is not 0, and the command source is 485, this value = Pr09-10 * Pr00-26 / Pr01-00
	211FH	High byte: decimal of current value (display)
	2200H	Display output current (A). When current is higher than 655.35,it will shift decimal as (XXX.XA) . The decimal can refer to High byte of 211F.
	2201H	Display counter value (c)
	2202H	Actual output frequency (XXXXXHz)
	2203H	DC-BUS voltage (XXX.XV)
	2204H	Output voltage (XXX.XV)
	2205H	Power angle (XXX.X)
	2206H	Display actual motor speed kW of U, V, W (XXXXXkW)
	2207H	Display motor speed in rpm estimated by the drive or encoder feedback (XXXXXrpm)
	2208H	Display positive/negative output torque in %, estimated by the drive (t0.0: positive torque, -0.0: negative torque) (XXX.X%)
	2209H	Reserved
	220AH	PID feedback value after enabling PID function (XXX.XX%)
	220BH	Display signal of AVI1 analog input terminal, 0~10V corresponds to 0.00~100.00% (1.) (as Pr. 00-04 NOTE 2)

Content	Register	Function
	220CH	Display signal of AC1 analog input terminal, 4~20mA/0~10V corresponds to 0.00~100.00% (2.) (as Pr. 00-04 NOTE 2)
	220DH	Display signal of AVI2 analog input terminal, 0V~10V corresponds to 0.00~100% (3.) (as Pr. 00-04 NOTE 2)
	220EH	IGBT temperature of drive power module (XXX.X°C)
	220FH	The temperature of capacitance (XXX.X°C)
	2210H	The status of digital input (ON/OFF), refer to Pr.02-12 (as Pr. 00-04 NOTE 3)
	2211H	The status of digital output (ON/OFF), refer to Pr.02-18 (as Pr. 00-04 NOTE 4)
	2212H	The multi-step speed that is executing (S)
	2213H	The corresponding CPU pin status of digital input (d.) (as Pr. 00-04 NOTE 3)
	2214H	The corresponding CPU pin status of digital output (O.) (as Pr. 00-04 NOTE 4)
	2215H ~ 2218H	Reserved
	2219H	Display times of counter overload (XXX.XX%)
	221AH	GFF (XXX.XX%)
	221BH	DCbus voltage ripples (XXX.XV)
	221CH	PLC register D1043 data (C)
	221DH	Reserved
	221EH	User page displays the value in physical measure
	221FH	Output Value of Pr.00-05 (XXX.XXHz)
	2220H	Number of revolutions of the motor
	2221H	Motor running position
	2222H	Fan speed of the drive (XXX%)
	2223H	Control mode of the drive 0: speed mode 1: torque mode
	2224H	Carrier frequency of the drive (XXKHZ)
	2225H	Reserved
	2226H	Drive status bit 1~0 00b: No direction 01b: Forward 10b: Reverse bit 3~2 01b: Driver ready 10b: Error bit 4 0b: Motor drive did not output 1b: Motor drive did output bit 5 0b: No alarm 1b: Have Alarm
	2227H	Drive's estimated output torque(positive or negative direction) (XXXX Nt-m)
	2228H	Reserved
	2229H	KWH display (XXXX.X)
	222AH ~ 222DH	Reserved
	222EH	PID reference (XXX.XX%)
	222FH	PID offset (XXX.XX%)
	2230H	PID output frequency (XXX.XXHz)
	2231H	Hardware ID

5. Exception response:

The AC motor drive is expected to return a normal response after receiving command messages from the master device. The following depicts the conditions when no normal response is replied to the master device.

The AC motor drive does not receive the messages due to a communication error; thus, the AC motor drive has no response. The master device will eventually process a timeout condition.

The AC motor drive receives the messages without a communication error, but cannot handle them. An exception response will be returned to the master device and an error message “CExx” will be displayed on the keypad of AC motor drive. The xx of “CExx” is a decimal code equal to the exception code that is described below.

In the exception response, the most significant bit of the original command code is set to 1, and an exception code which explains the condition that caused the exception is returned.

Example:

ASCII mode:		RTU mode:	
STX	‘.’	Address	01H
Address	‘0’	Function	86H
	‘1’	Exception code	02H
Function	‘8’	CRC CHK Low	C3H
	‘6’	CRC CHK High	A1H
Exception code	‘0’		
	‘2’		
LRC CHK	‘7’		
	‘7’		
END	CR		
	LF		

The explanation of exception codes:

Exception code	Explanation
1	Function code is not supported or unrecognized.
2	Address is not supported or unrecognized.
3	Data is not correct or unrecognized.
4	Fail to execute this function code

09-09 Response Delay Time

Factory Setting: 2.0

Settings 0.0~200.0ms

This parameter is the response delay time after AC drive receives communication command as shown in the following.

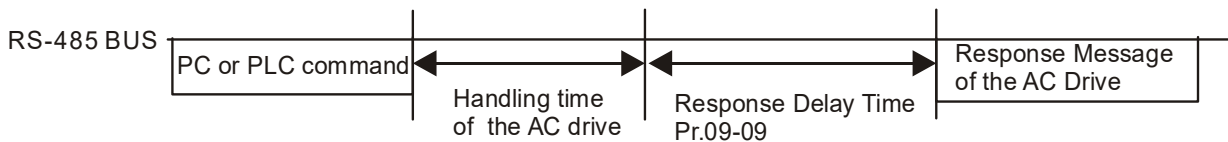

09-10 Main Frequency of the Communication

Factory Setting: 60.00

Settings 0.00~599.00Hz

When Pr.00-20 is set to 1 (RS485 communication). The AC motor drive will save the last frequency command into Pr.09-10 when abnormal turn-off or momentary power loss. After reboots the power, it will regard the frequency set in Pr.09-10 if no new frequency command is inputted. When frequency command of 485 is changed (the source of frequency command needs to be set as MODBUS), this parameter is also be changed.

↗	09-11	Block Transfer 1
↗	09-12	Block Transfer 2
↗	09-13	Block Transfer 3
↗	09-14	Block Transfer 4
↗	09-15	Block Transfer 5
↗	09-16	Block Transfer 6
↗	09-17	Block Transfer 7
↗	09-18	Block Transfer 8
↗	09-19	Block Transfer 9
↗	09-20	Block Transfer 10
↗	09-21	Block Transfer 11
↗	09-22	Block Transfer 12
↗	09-23	Block Transfer 13
↗	09-24	Block Transfer 14
↗	09-25	Block Transfer 15
↗	09-26	Block Transfer 16

Factory Setting: 0000

Settings 0~FFFFh

 There is a group of block transfer parameter available in the AC motor drive (Pr.09-11 to Pr.09-26). Through communication code 03H, users can use Pr.09-11 to Pr.09-26 to save those parameters that they want to read.

09-30 Communication Decoding Method

Factory Setting: 1

Settings 0: Decoding Method 1 (20xx)
1: Decoding Method 2 (60xx)



		Decoding Method 1	Decoding Method 2
Source of Operation Control	Digital Keypad	Digital keypad controls the drive action regardless decoding method 1 or 2.	
	External Terminal	External terminal controls the drive action regardless decoding method 1 or 2.	
	RS-485	Refer to address: 2000h~20FFh	Refer to address: 6000h ~ 60FFh
	CANopen	Refer to index: 2020-01h~2020-FFh	Refer to index:2060-01h ~ 2060-FFh
	Communication Card	Refer to address: 2000h ~ 20FFh	Refer to address: 6000h ~ 60FFh
PLC		PLC commands the drive action regardless decoding method 1 or 2.	

09-31 Internal Communication Protocol

Factory Setting: 0

Settings -12: Internal PLC Control
-10: Internal Communication Master
-8: Internal Communication Slave 8
-7: Internal Communication Slave 7
-6: Internal Communication Slave 6

- 5: Internal Communication Slave 5
- 4: Internal Communication Slave 4
- 3: Internal Communication Slave 3
- 2: Internal Communication Slave 2
- 1: Internal Communication Slave 1
- 0: Modbus 485
- 1: BACnet

-  When it is defined as internal communication, see CH16-10 for information on Main Control Terminal of Internal Communication.
-  When it is defined as internal PLC control, see CH16-12 for Remote IO control application (by using MODRW).

09-33 PLC command force to 0

Factory Setting : 0000

Setting 0~FFFFh

-  It defines the action that before PLC scans time sequence, the frequency command or speed command needs to be cleared as 0 or not.

Bit	Explanation
Bit0	Before PLC scan, set up PLC target frequency=0
Bit1	Before PLC scan, set up the PLC target torque=0
Bit2	Before PLC scan, set up the speed limit of torque control mode=0

09-35 PLC Address

Factory Setting: 2

Settings 1~254

09-36 CANopen Slave Address

Factory Setting: 0

Settings 0: Disable
0~127

09-37 CANopen Speed

Factory Setting: 0

Settings 0: 1Mbps
1: 500Kbps
2: 250Kbps
3: 125Kbps
4: 100Kbps (Delta only)
5: 50Kbps

09-39 CANopen Warning Record

Factory Setting: 0

Settings bit 0: CANopen Guarding Time out
bit 1: CANopen Heartbeat Time out
bit 2: CANopen SYNC Time out
bit 3: CANopen SDO Time out
bit 4: CANopen SDO buffer overflow

bit 5: Can Bus Off

bit 6: Error protocol of CANOPEN

bit 8: The setting values of CANopen indexes are fail

bit 9: The setting value of CANopen address is fail

bit10: The checksum value of CANopen indexes is fail

09-40 CANopen Decoding Method

Factory Setting: 1

Settings 0: Delta defined decoding method
1: CANopen Standard DS402 protocol

09-41 CANopen Status

Factory Setting: Read Only

Settings 0: Node Reset State
1: Com Reset State
2: Boot up State
3: Pre Operation State
4: Operation State
5: Stop State

09-42 CANopen Control Status

Factory Setting: Read Only

Settings 0: Not ready for use state
1: Inhibit start state
2: Ready to switch on state
3: Switched on state
4: Enable operation state
7: Quick stop active state
13: Error reaction activation state
14: Error state

09-45 CANopen Master Function

Factory Setting: 0

Settings 0: Disable
1: Enable

09-46 CANopen Master Address

Factory Setting: 100

Settings 0~127

09-50 BACnet Dnet (MAC ID)

Factory Setting: 10

Settings 0~127

09-51 BACnet Baud Rate

Factory Setting: 38.4

Settings 9.66~76.8 Kbps

09-52	BACnet Device ID L	Factory Setting: 10
	Settings 0~65535	
09-53	BACnet Device ID H	Factory Setting: 0
	Settings 0~63	
09-55	BACnet Max Address	Factory Setting: 127
	Settings 0~127	
09-56	BACnet Password	Factory Setting: 0
	Settings 0~65535	
09-60	Identifications for Communication Card	Factory Setting: 0
	Settings 0: No communication card 1: DeviceNet Slave 2: Profibus-DP Slave 3: CANopen Slave/Master 4: Modbus-TCP Slave 5: EtherNet/IP Slave	
09-61	Firmware Version of Communication Card	Factory Setting: ##
	Settings Read only	
09-62	Product Code	Factory Setting: ##
	Settings Read only	
09-63	Fault Code	Factory Setting: ##
	Settings Read only	
09-70	Address of Communication Card (for DeviceNet and PROFIBUS)	Factory Setting: 1
	Settings DeviceNet: 0~63 Profibus-DP: 1~125	
09-71	Setting of DeviceNet Speed (for DeviceNet and PROFIBUS)	Factory Setting: 2
	Settings Standard DeviceNet: 0: 125Kbps 1: 250Kbps 2: 500Kbps 3: 1Mbps (Delta only)	

Non standard DeviceNet : (Delta only)

- 0: 10Kbps
- 1: 20Kbps
- 2: 50Kbps
- 3: 100Kbps
- 4: 125Kbps
- 5: 250Kbps
- 6: 500Kbps
- 7: 800Kbps
- 8: 1Mbps

✎ **09-72** Other Setting of DeviceNet Speed (for DeviceNet and PROFIBUS)

Factory Setting: 0

Settings 0: Standard DeviceNet
1: Nonstandard DeviceNet

📖 It needs to use with Pr.09-71.

📖 Setting 0: the baud rate can only be set to 125Kbps, 250Kbps or 500Kbps.

📖 Setting 1: setting of DeviceNet communication rate can be the same as CANopen (setting 0-8).

✎ **09-75** IP Configuration of the Communication Card (for MODBUS TCP)

Factory Setting: 0

Settings 0~65535
0: Static IP
1: DynamicIP (DHCP)

📖 Setting 0: it needs to set IP address manually.

📖 Setting 1: IP address will be auto set by host controller.

✎ **09-76** IP Address 1 of the Communication Card (for MODBUS TCP)

✎ **09-77** IP Address 2 of the Communication Card (for MODBUS TCP)

✎ **09-78** IP Address 3 of the Communication Card (for MODBUS TCP)

✎ **09-79** IP Address 4 of the Communication Card (for MODBUS TCP)

Factory Setting: 0

Settings 0~65535

📖 Pr.09-76~09-79 needs to use with communication card.

✎ **09-80** Address Mask 1 of the Communication Card (for MODBUS TCP)

✎ **09-81** Address Mask 2 of the Communication Card (for MODBUS TCP)

✎ **09-82** Address Mask 3 of the Communication Card (for MODBUS TCP)

✎ **09-83** Address Mask 4 of the Communication Card (for MODBUS TCP)

Factory Setting: 0

Settings 0~65535

↗	09-84	Gateway Address 1 of the Communication Card (for MODBUS TCP)
↗	09-85	Gateway Address 2 of the Communication Card (for MODBUS TCP)
↗	09-86	Gateway Address 3 of the Communication Card (for MODBUS TCP)
↗	09-87	Gateway Address 4 of the Communication Card (for MODBUS TCP)

Factory Setting: 0

Settings 0~65535

↗	09-88	Password for Communication Card (Low word) (for MODBUS TCP)
↗	09-89	Password for Communication Card (High word) (for MODBUS TCP)

Factory Setting: 0

Settings 0~99

↗	09-90	Reset Communication Card (for MODBUS TCP)
---	--------------	---

Factory Setting: 0

Settings 0: Disable

1: Reset, return to factory setting

↗	09-91	Additional Setting for Communication Card (for MODBUS TCP)
---	--------------	--

Factory Setting: 1

Settings Bit 0: Enable IP Filter

Bit 1: Internet parameters enable(1bit)

When IP address is set up, this bit need to be enabled to write down the parameters. This bit will change to disable when it finishes saving the update of internet parameters.

Bit 2: Login password enable(1bit)

When enter login password, this bit will be enabled. After updating the parameters of communication card, this bit will change to disable.

	09-92	Status of Communication Card (for MODBUS TCP)
--	--------------	---

Factory Setting: 0











Settings Bit 0: password enable

When the communication card is set with password, this bit is enabled.

When the password is clear, this bit is disabled.

10 Speed Feedback Control Parameters

✎ This parameter can be set during operation.

- ✎ **10-31** I/F Mode, current command
- Factory Setting: 40
- Settings 0~150% rated current of motor
-  The parameter is the current command of the drive in low-speed area (low-speed area: frequency command < Pr.10-39). When it is stalling on heavy duty start-up or forward / reverse with load, adjust the parameter (increase). If inrush current is too high to cause oc stall, then decrease it.
-
- ✎ **10-32** PM Sensorless Observer Bandwidth for High Speed Zone
- Factory Setting: 5.00
- Settings 0.00~600.00Hz
-  The parameter is speed estimator bandwidth. Adjust the parameter will influence the stability and the accuracy of speed for motor.
-  If there is low frequency vibrates (the waveform is similar to sin wave) during the process, then increase the bandwidth. If there is high frequency vibrates (the waveform vibrates extremely and is like spur), then decrease the bandwidth.
-
- ✎ **10-34** PM Sensorless Observer Low-pass Filter Gain
- Factory Setting: 1.00
- Settings 0.00~655.35
-  Adjust the parameter will influence the response speed of speed estimator.
-  If there is low frequency vibrates (the waveform is similar to sin wave) during the process, then increase the gain. If there is high frequency vibrates (the waveform vibrates extremely and is like spur), then decrease the gain.
-
- ✎ **10-39** Frequency Point when switch from I/F mode to PM Sensorless mode
- Factory Setting: 20.00
- Settings 0.00~599.00Hz
-  The parameter is the switch point, which is from low frequency to high frequency.
-  If the switch point is too low, motor will not generate enough back EMF to let the speed estimator measure the right position and speed of rotator, and cause stall and oc when the frequency of switch point is running.
-  If the switch point is too high, the active area of I/F will be too wide, which will generate larger current and cannot save energy. (The reason is that if the current of Pr.10-31 sets too high, and the high switch point will make the drive keeps outputting with the setting value of Pr.10-31).
-
- ✎ **10-40** Frequency Point when Switch from PM Sensorless Mode to I/F Mode
- Factory Setting: 20.00
- Settings 0.00~599.00Hz
-  The parameter is the switch point, which is from high frequency to low frequency.
-  If the switch point is too low, motor will not generate enough back EMF to let the speed



estimator measure the right position and speed of rotator when the frequency of switch point is running.

-  If the switch point is too high, the active area of I/F will be too wide, which will generate larger current and cannot save energy. (The reason is that if the current of Pr.10-31 sets too high, and the high switch point will make the drive keeps outputting with the setting value of Pr.10-31).

 **10-41** I/F mode, low pass-filter time

Factory Setting: 0.2



Settings 0.0~6.0 sec

-  This parameter is the filter time of Pr.10-31.It can let magnetic field under I/F mode increased smoothly to the current command setting value.
-  If you want to increase the size of Id slowly, you can adjust high to avoid the starting current output Step phenomenon; If you adjust to low (minimum 0), the faster the current rises, there will be a Step phenomenon.

 **10-42** Initial Angle Detection Pulse Value

Factory Setting: 1.0





Settings 0.0~3.0 times of motor rated current

-  This parameter is only available when Pr.10-53=2 or 3.
-  The parameter influences the value of pulse during the angle detection. The larger the pulse is, the higher of the accuracy of rotator’s position reaches. But it might cause an over current trip up more easily.
-  Increase the parameter when the running direction and the command are opposite while start-up. If over current occurs in the start-up moment, then decrease the parameter.

 **10-49** Zero voltage time while start up

Factory Setting: 00.000

Settings 00.000~60.000 sec

-  When the motor is in static status at the startup, the accuracy to estimate angles will be increased. In order to make the motor in “static status”, the drive 3 phase U, V, W output 0V to motor to reach this goal. The Pr.10-49 setting time is the length of time when three-phase output 0V.
-  It is possible that even when this parameter is being applied but the motor at the installation site cannot go in to the “static status” caused by the inertia or by any external force. So, if the motor doesn’t go into a complete “static status” in 0.2 sec, increase appropriately this setting value.
-  This parameter is functional only when the setting of Pr.07-12 Speed Search during Startup ≠0.
-  When the Pr.10-49 is set too large, it will obviously delay the start-up time. But when the parameter is set to small, the braking capacity would be insufficient.



 **10-51** Injection Frequency

Factory Setting: 500

Settings 0~1200Hz

-  This parameter is a high frequency injection command in PM SVC control mode, and usually it doesn’t need to be adjusted. But if a motor’s rated frequency (i.e. 400 Hz) is too close to the frequency setting of this parameter (i.e. factory setting 500 Hz), the accuracy of angles detected





will be affected. Therefore, refer to the setting of Pr.01-01 before adjusting this parameter.

-  If the setting value of Pr.00-17 is lower than Pr.10-51*10, then increase the frequency of carrier wave.
-  Pr.10-51 is valid only when Pr.10-53 = 2.

↗ **10-52** Injection Magnitude

Factory Setting: 15.0/30.0

Settings 0.0~200.0V

-  The parameter is magnitude command of high frequency injection signal in PM SVC control mode.
-  Increasing the parameter can get more accurate estimated value of angle. But the noise of electromagnetic might be louder if the setting value is too high.
-  This parameter will be received when motor's parameter is "Auto". And this parameter will influence the accuracy of angle's estimation.
-  When the ratio of salient pole (L_q / L_d) is lower, increase Pr. 10-52 to make angle detection be accurate.
-  Pr.10-52 is valid only when Pr. 10-53 = 2.

↗ **10-53** PM Motor Rotor Initial Angle Position Detection Method

Factory Setting : 0

Settings 0 : Disabled

1 : Internal 1/4 rated current attracting the rotor to zero degrees

2 : High frequency injection

3 : Pulse injection

-  It is suggested to set as "2" if it is IPM; set as "3" if it is SPM. If there is bad effect when set as "2" or "3", then set as "1".

11 Advanced Parameters

Group 11 Advanced parameters are reserved.

12 Pump Parameters

✦ This parameter can be set during operation.

12-00 Circulative Control

Factory Setting: 0

- Settings 0: No operation
- 1: Fixed Time Circulation (by time)
- 2: Fixed Quantity
- 3: Fixed Quantity Control
- 4: Fixed Time Circulation + Fixed Quantity Circulation
- 5: Fixed Time Circulation + Fixed Quantity Control

📖 In this mode, CFP2000 can control up to 8 motors at a time. The total number of the motors can be determined by Pr.12-01. In accordance with the Fixed Time Circulation of Pr12-02, you can adjust the switching time between Start/Stop of each motor. That means when an operating motor reaches the time setting of Pr12-02, CFP2000 will stop that motor. Then after the delay time setting of Pr12-03, next motor will start operating. See diagram below.

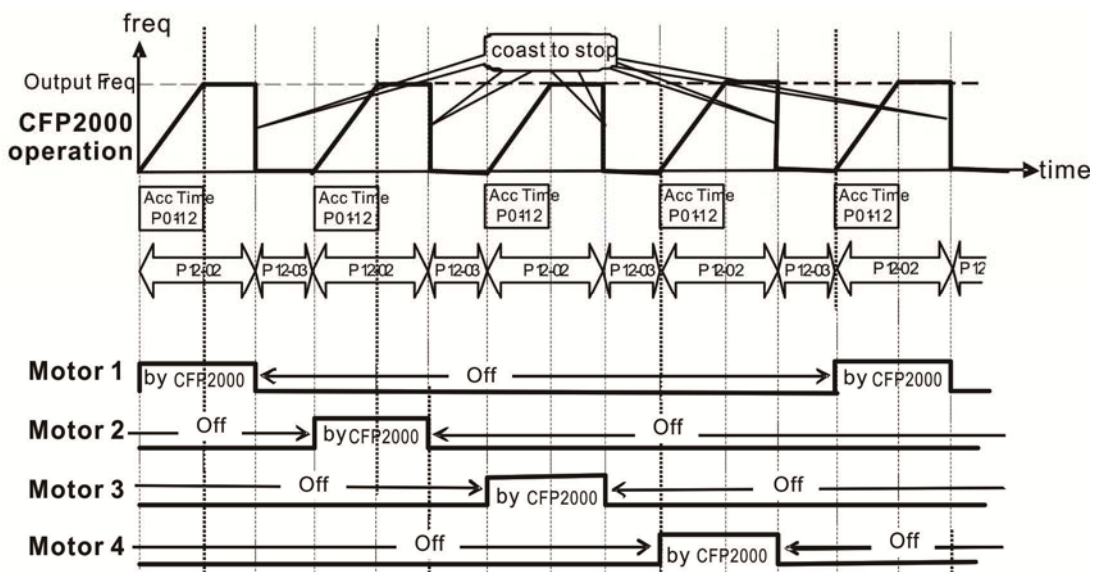



Diagram 12-1: Sequential Diagram of the Fixed Time Circulation (by time)

📖 Disable Motors' Output

Set the Multifunction Input Commands as Disable Motors' Output can stop corresponding motors. The settings are:

P02-01~P02-06=	60	61	62	63	64	65	66	67	68
Disable Motors' Output	ALL	1	2	3	4	5	6	7	8

When a motor's output is disabled, this motor will park freely.

 **Wiring:** Fixed Time Circulation (by time) Control can control up to 8 motors. The diagram 12-2 is an example of controlling 4 motors at the same time.

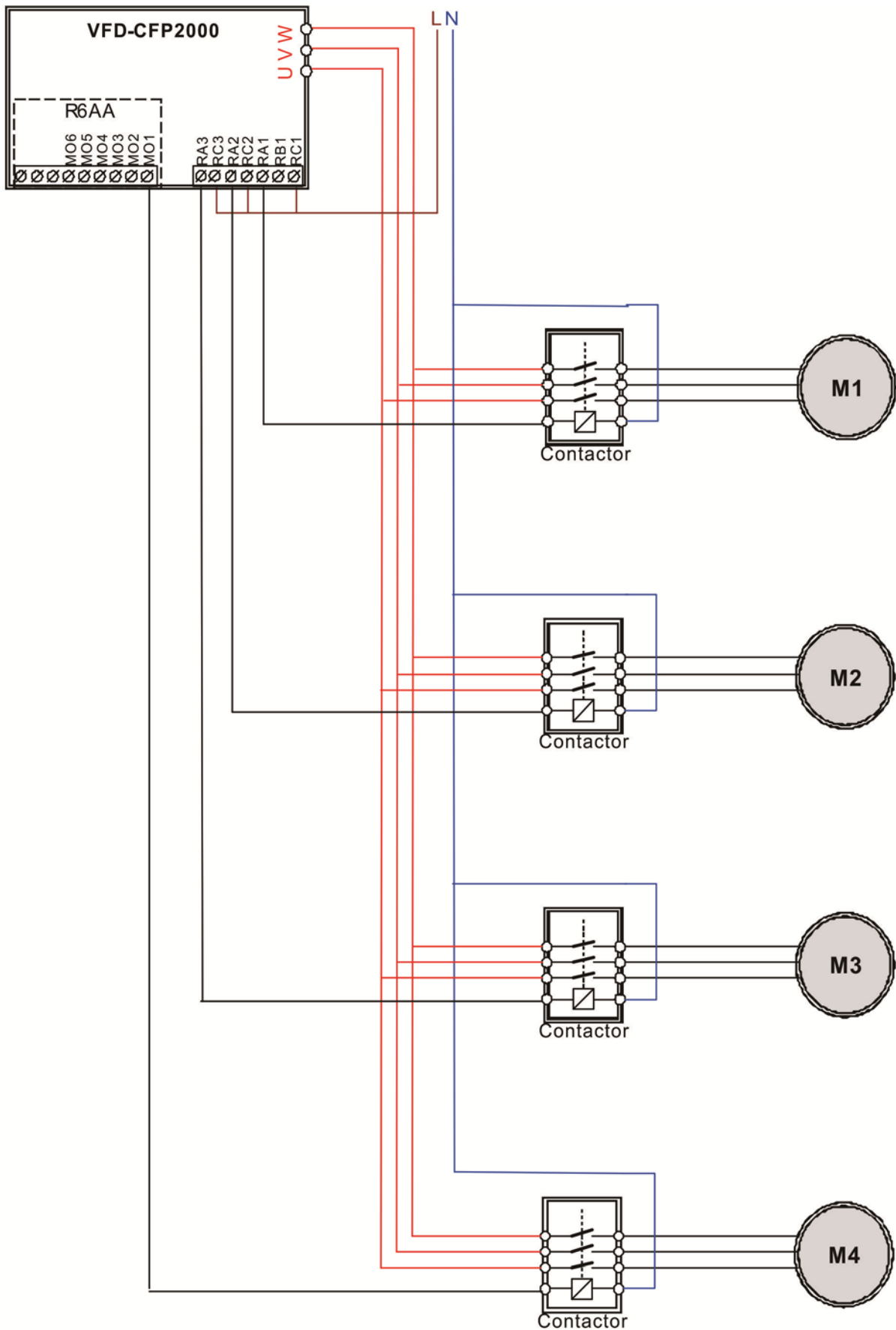

Diagram 12-2: Wiring

12-01 Number of Motors to be connected

Factory Setting: 1

Settings 1~8

Number of Motors: Maximum 8 motors. After setting number of motor to be connected at the same time, multi-function output terminals will follow automatically the setting as shown in the table below.

P12-01	01	02	03	04	05	06	07	08
P02-13	55	55	55	55	55	55	55	55
P02-14		56	56	56	56	56	56	56
P02-15			57	57	57	57	57	57
P02-36				58	58	58	58	58
P02-37					59	59	59	59
P02-38						60	60	60
P02-39							61	61
P02-40								62

Table 1: Setting of Multi-function Output Terminal on Circulating Motors**12-02** Operating time of each motor (minutes)

Factory Setting: 0

Settings 0~65500 minutes

 Setting of Fixed Time Circulation by minute. If Pr12-02 = 0, that means stop timing, the current running motors will keep on operating until a stop command is given.

12-03 Delay Time due to the Acceleration (or the Increment) at Motor Switching (seconds)

Factory Setting: 1.0

Settings 0.0~3600.0 seconds

 Delay time when switching motors in seconds. When the current running motors reach the time setting of Pr12-02, CFP2000 will follow the delay time setting of Pr12-03 and then switch to run the next motors.

12-04 Delay Time due to the Deceleration (or the Decrement) at Motor Switching (seconds)

Factory Setting: 1.0

Settings 0.0~3600.0 seconds

 **12-05** Delay time while fixed quantity circulation at Motor Switching (seconds)

Factory Setting: 100

Settings 0.0~3600.0 seconds

 Fixed quantity circulation with PID

Sequential Diagram

In this mode, CFP2000 can control up to 4 motors to increase controlling flow quantity and pressure range. When controlling flow quantity, motors will be in parallel connection. When controlling pressure range, motors will be in series connection.

If need to increase flow quantity or pressure range, CFP2000 will increase first motor’s pressure from 0Hz to the largest operating frequency. If output frequency reaches the frequency setting of Pr12-06 and delay time of Pr12-05, then CFP2000 will delay the time setting of Pr12-03. Then CFP2000 will switch the motor to use mains electricity and delay the time setting of Pr12-03 to run next motor. If necessary, other motors will be activated in sequence. See sequential diagram of 12-3 and 12-4.

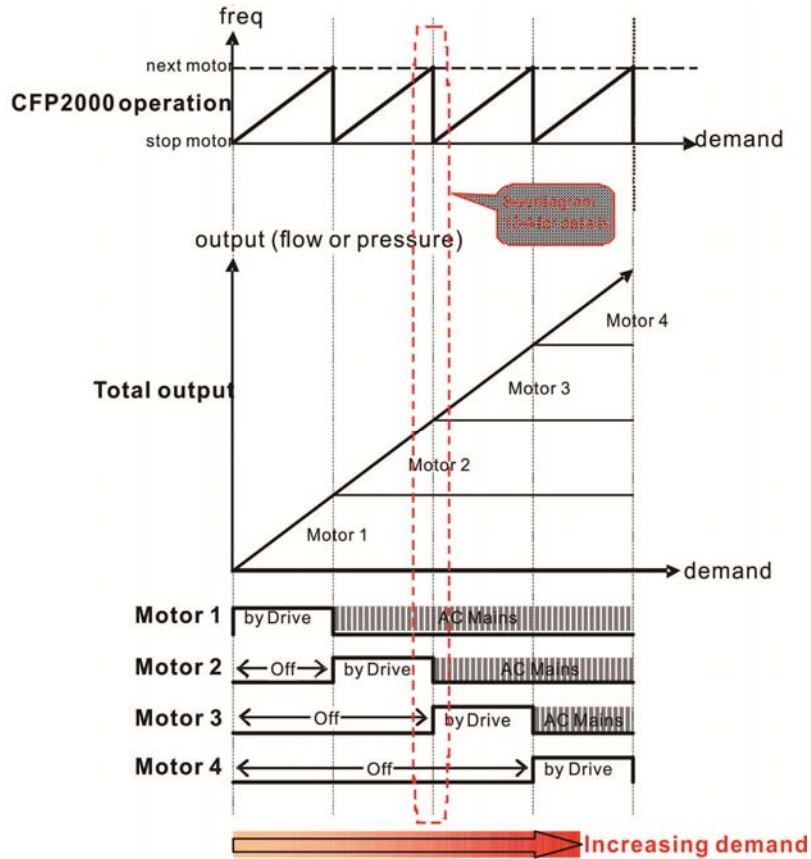

Diagram 12-3: Sequence of Fixed quantity circulation with PID – Increasing Demand

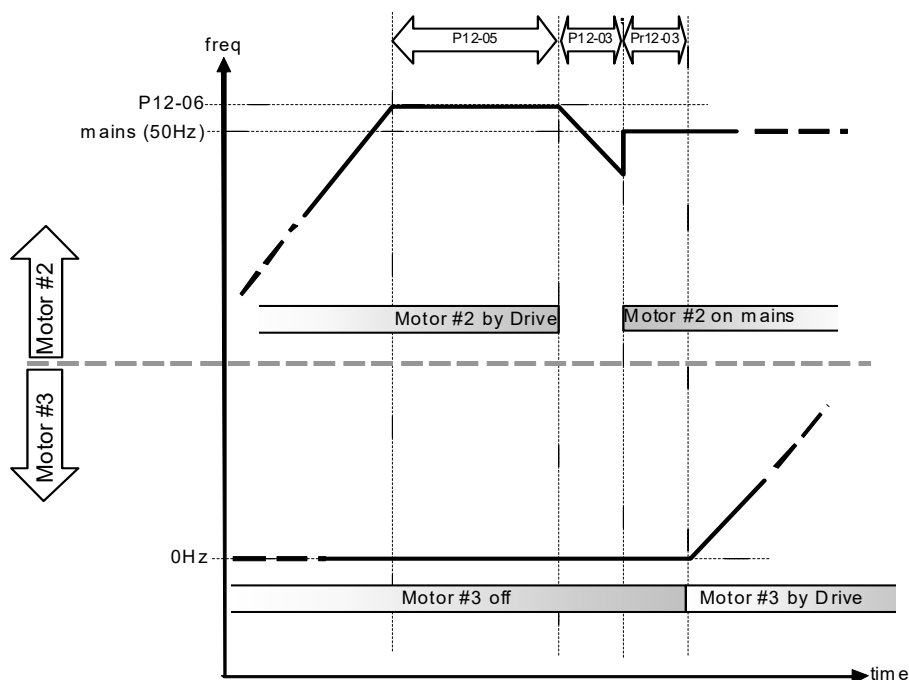

Diagram 12-4: Sequence of switching motors at fixed quantity circulation with PID – Increasing Demands

However, if decreasing demands when flow quantity and pressure are too big, CFP2000 will stop the current operating motors and wait for the delay time setting of Pr12-04. Then keep on doing this until the last motor stop using mains electricity. See sequential diagram 12-5 and 12-6 below.

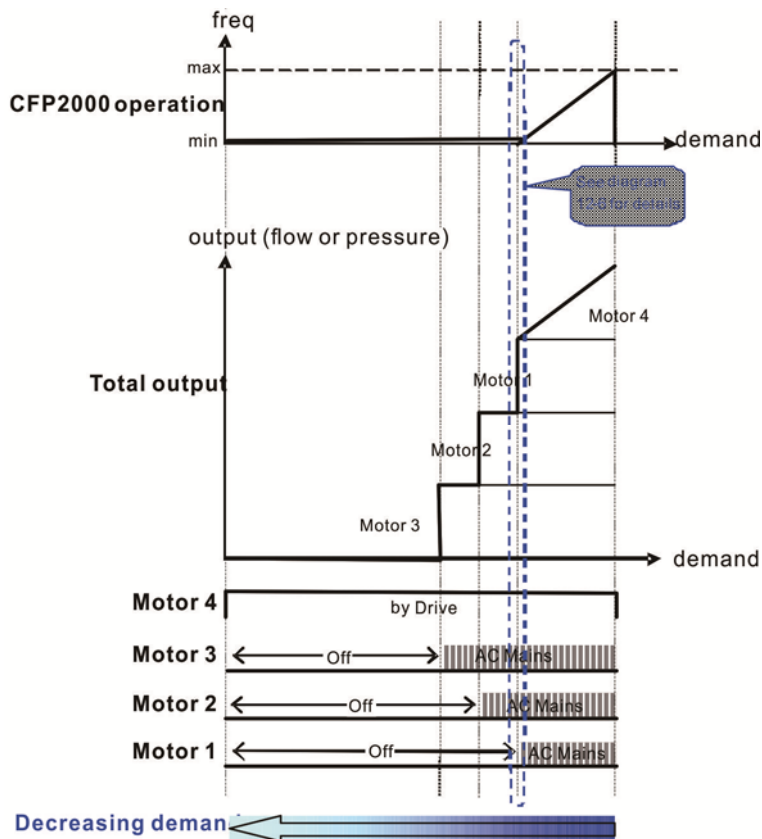

Diagram 12-5: Sequence of switching motors at fixed quantity circulation with PID – Decreasing Demands

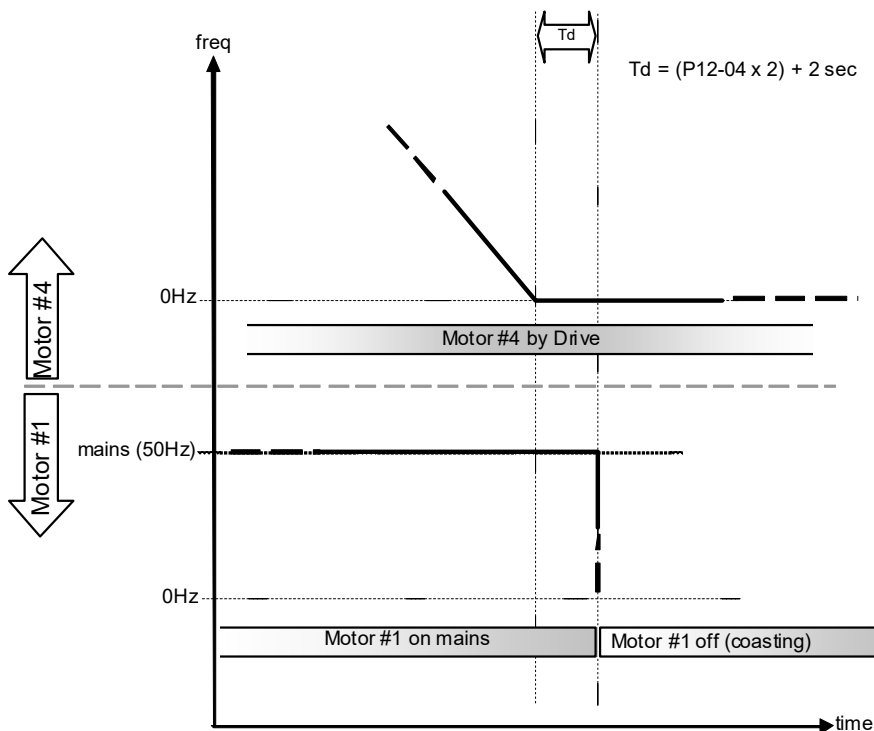

Diagram 12-6: Sequence of switching motors at fixed quantity circulation with PID – Decreasing Demands

 Parameter Setting

Parameter Setting	Description																																																																																										
P12-00=2	Choose Fixed quantity circulation with PID																																																																																										
P12-01=X	<p>Number of Motors: Maximum 4 motors. After setting number of motor to be connected at the same time, multi-function output terminals will follow automatically the setting as shown in the table below.</p> <table border="1" style="width: 100%; border-collapse: collapse;"> <tr> <td>P12-01</td> <td>01</td> <td>01</td> <td>02</td> <td>02</td> <td>03</td> <td>03</td> <td>04</td> <td>04</td> <td></td> </tr> <tr> <td>P02-13</td> <td>55</td> <td>55</td> <td>55</td> <td>55</td> <td>55</td> <td>55</td> <td>55</td> <td>55</td> <td>Motor #1 by Drive</td> </tr> <tr> <td>P02-14</td> <td></td> <td>56</td> <td>56</td> <td>56</td> <td>56</td> <td>56</td> <td>56</td> <td>56</td> <td>Motor #1 by Mains</td> </tr> <tr> <td>P02-15</td> <td></td> <td></td> <td>57</td> <td>57</td> <td>57</td> <td>57</td> <td>57</td> <td>57</td> <td>Motor #2 by Drive</td> </tr> <tr> <td>P02-36</td> <td></td> <td></td> <td></td> <td>58</td> <td>58</td> <td>58</td> <td>58</td> <td>58</td> <td>Motor #2 by Mains</td> </tr> <tr> <td>P02-37</td> <td></td> <td></td> <td></td> <td></td> <td>59</td> <td>59</td> <td>59</td> <td>59</td> <td>Motor #3 by Drive</td> </tr> <tr> <td>P02-38</td> <td></td> <td></td> <td></td> <td></td> <td></td> <td>60</td> <td>60</td> <td>60</td> <td>Motor #3 by Mains</td> </tr> <tr> <td>P02-39</td> <td></td> <td></td> <td></td> <td></td> <td></td> <td></td> <td>61</td> <td>61</td> <td>Motor #4 by Drive</td> </tr> <tr> <td>P02-40</td> <td></td> <td></td> <td></td> <td></td> <td></td> <td></td> <td></td> <td>62</td> <td>Motor #4 by Mains</td> </tr> </table> <p>Table 2: Setting of Multi-function Output Terminal on Circulating Motors</p>	P12-01	01	01	02	02	03	03	04	04		P02-13	55	55	55	55	55	55	55	55	Motor #1 by Drive	P02-14		56	56	56	56	56	56	56	Motor #1 by Mains	P02-15			57	57	57	57	57	57	Motor #2 by Drive	P02-36				58	58	58	58	58	Motor #2 by Mains	P02-37					59	59	59	59	Motor #3 by Drive	P02-38						60	60	60	Motor #3 by Mains	P02-39							61	61	Motor #4 by Drive	P02-40								62	Motor #4 by Mains
P12-01	01	01	02	02	03	03	04	04																																																																																			
P02-13	55	55	55	55	55	55	55	55	Motor #1 by Drive																																																																																		
P02-14		56	56	56	56	56	56	56	Motor #1 by Mains																																																																																		
P02-15			57	57	57	57	57	57	Motor #2 by Drive																																																																																		
P02-36				58	58	58	58	58	Motor #2 by Mains																																																																																		
P02-37					59	59	59	59	Motor #3 by Drive																																																																																		
P02-38						60	60	60	Motor #3 by Mains																																																																																		
P02-39							61	61	Motor #4 by Drive																																																																																		
P02-40								62	Motor #4 by Mains																																																																																		
P12-03=X	Delay Time due to the Acceleration (or the Increment) at Motor Switching (unit: second)																																																																																										
P12-04=X	Delay Time due to the Deceleration (or the Decrement) at Motor Switching (unit: sec)																																																																																										
P12-05=X	Delay time while fixed quantity circulation at Motor Switching with PID (unit: seconds)																																																																																										
P12-06=X	Frequency when switching motors at fixed quantity circulation (Hz)																																																																																										

 Disable Motor Output

Set the Multifunction Input Commands as Disable Motors' Output can stop corresponding motors.

The settings are:

P02-01~P02-06=	60	61	62	63	64	65	66	67	68
Disable Motor Output	ALL	1	2	3	4	5	6	7	8

When a motor's output is disabled, this motor will park freely

Fixed quantity circulation with PID can control up to 4 motors. The Diagram 12-7 below is an example of controlling 4 motors.

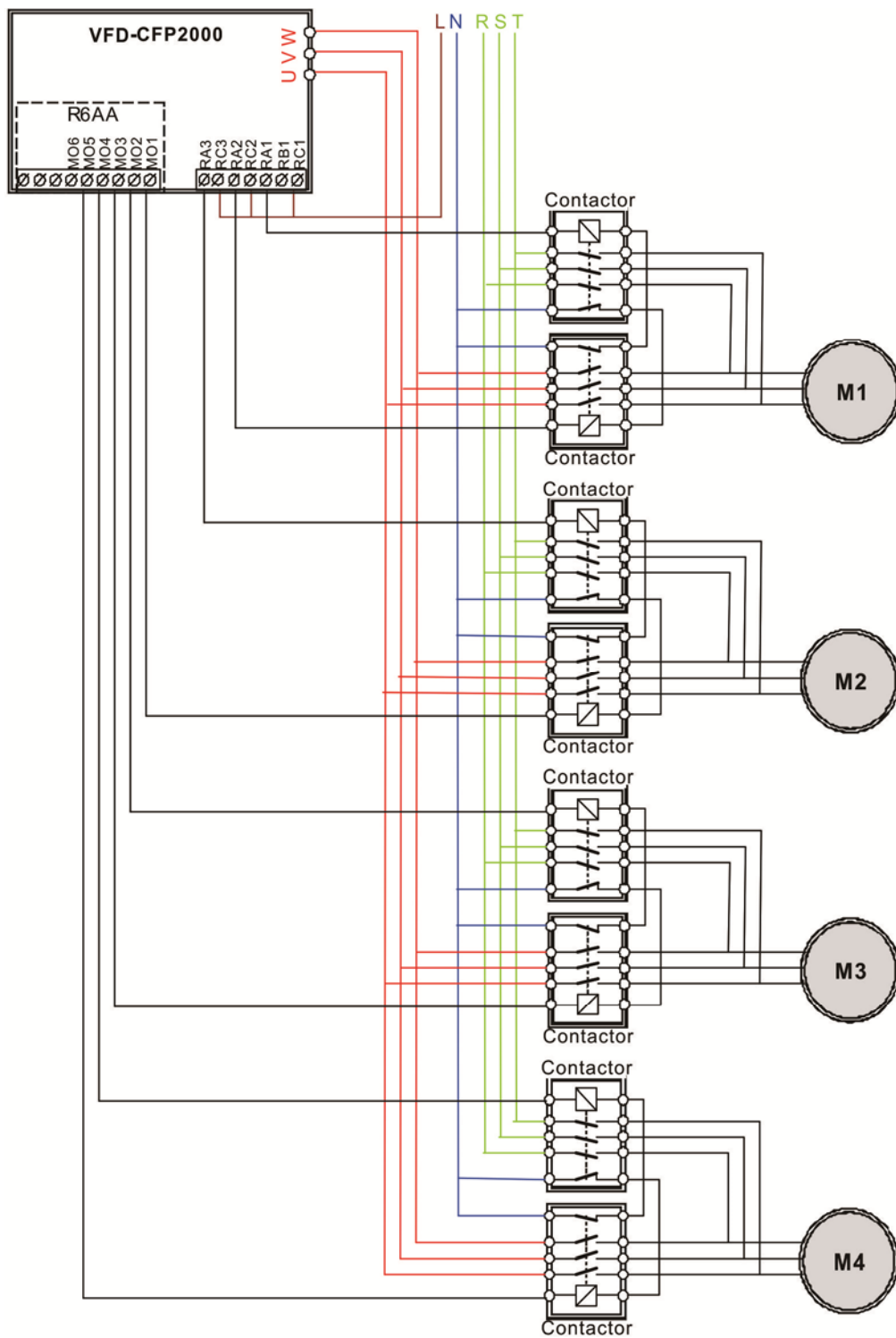

Diagram 12-7

12-06 Frequency when switching motors at fixed quantity circulation (Hz)

Factory Setting: 60.00

Settings 0.0~599.00 Hz

When the drive's output frequency reaches the setting value of Pr12-06, the system will start preparing to switch motors.

12-07 Actions to do when Fixed Quantity Circulation breaks down

Factory Setting: 0

Settings 0: Turn off all output

1: Motors powered by mains electricity continues to operate

12-08 Frequency when stopping auxiliary motor (Hz)

Factory Setting: 0

Settings 0.00~599.00 Hz

When the output frequency is smaller than the setting value of Pr12-08 and remains at the time setting of Pr12-04, motors will be shut down one by one.

Fixed quantity control with PID

In this mode, CFP2000 can control up to 8 motors to increase controlling flow quantity and pressure range.

CFP2000 connects directly to a main motor while the rest of motors are using mains electricity and controlled by a relay. When controlling flow quantity, motors will be in parallel connection. When controlling pressure range, motors will be in series connection.

If need to increase flow quantity or pressure range, CFP2000 will increase the main motor's pressure from 0Hz to the largest operating frequency. If necessary, CFP2000 will switch in sequence the motors to use mains electricity. See sequential diagram of 12-8 and 12-9.

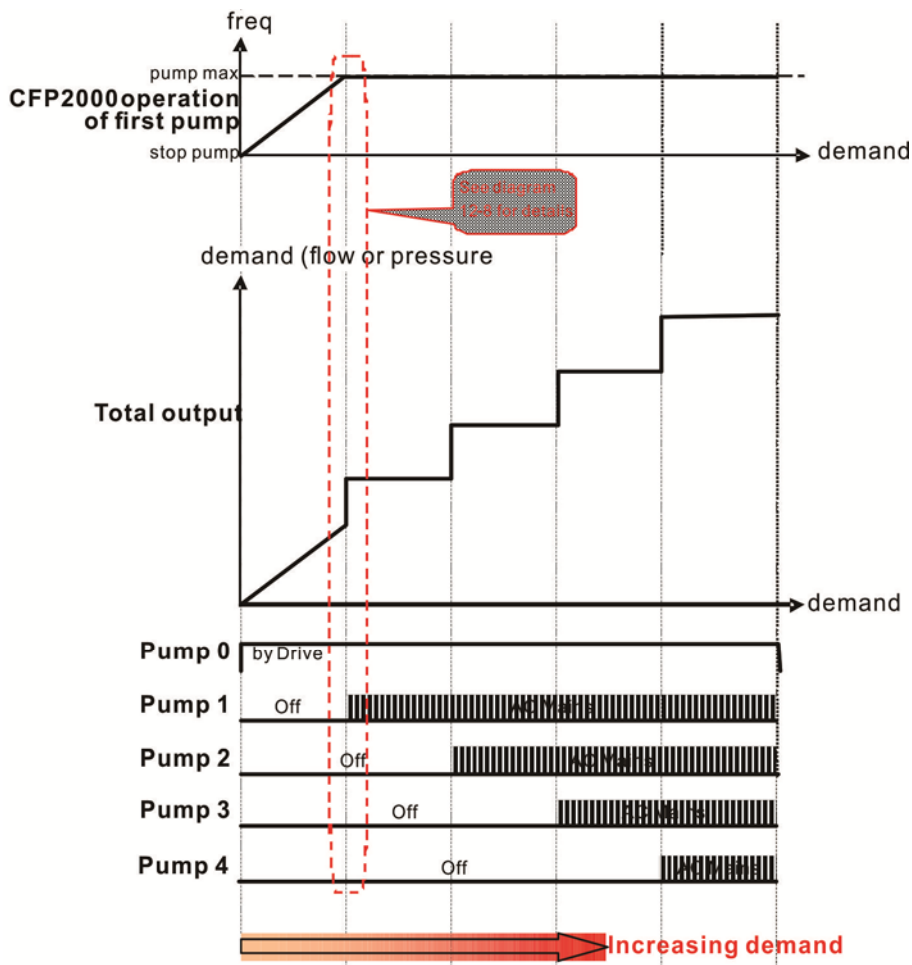

Diagram 12-8: Fixed quantity control with PID – Increasing Demand

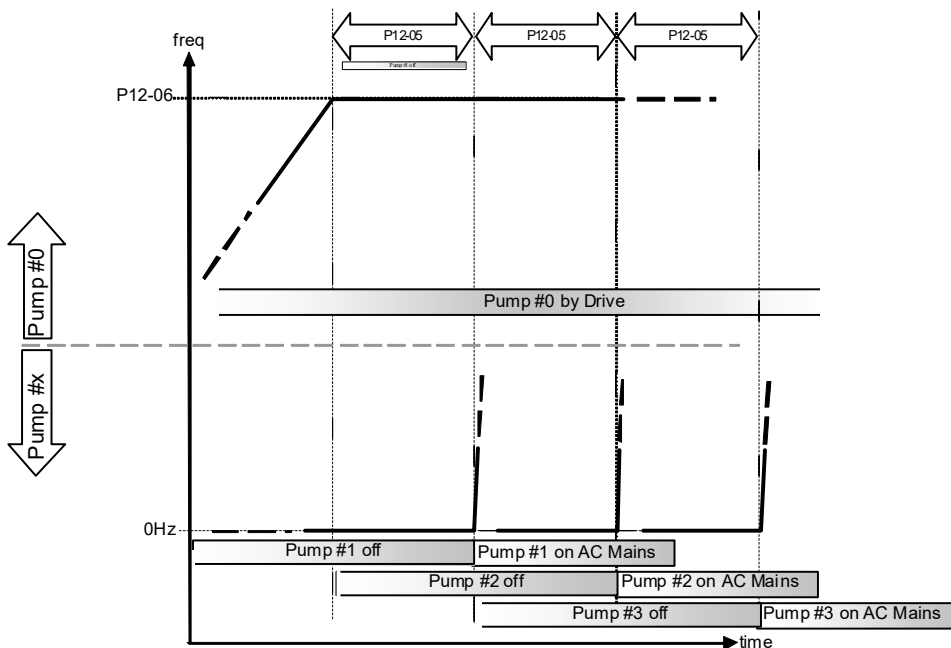

Diagram 12-9: Sequence of switching motors at fixed quantity control with PID – Increasing Demand

However, if the flow quantity or pressure is too big, CFP2000 will stop, one by one, the motors from using mains electricity until CFP2000 decrease the main motor’s frequency to 0Hz. See diagram 12-10 and diagram 12-11.

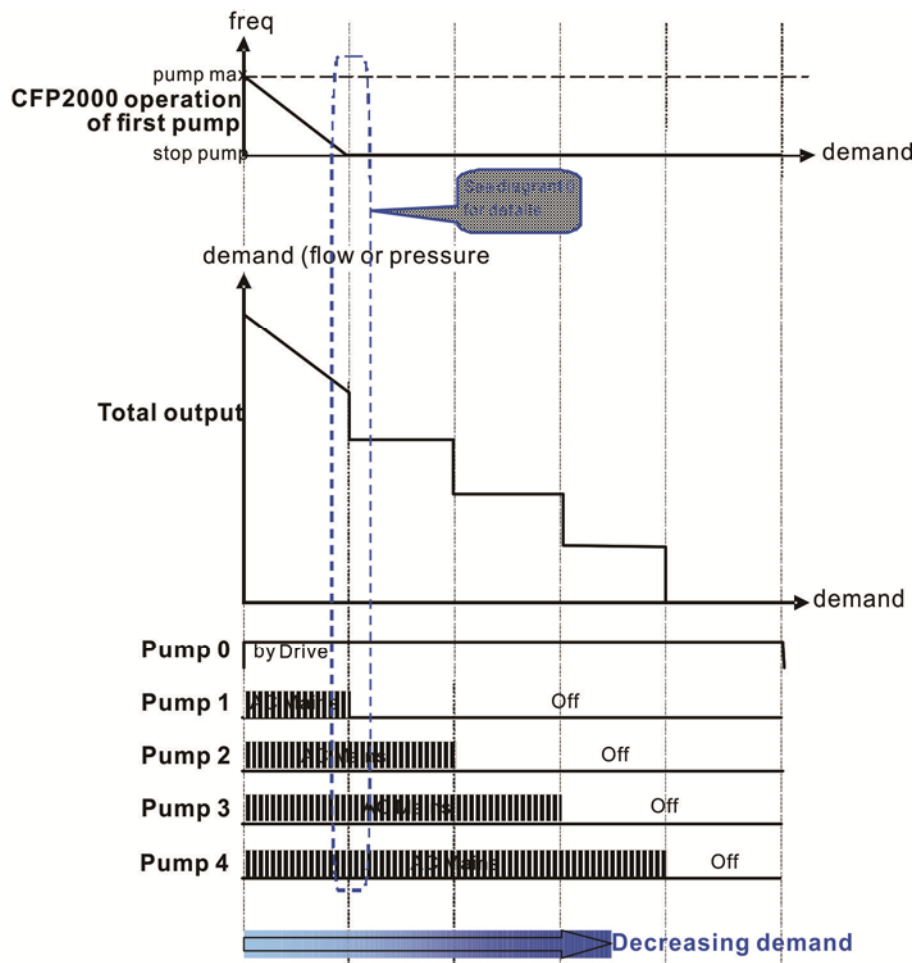

Diagram 12-10: Sequence of switching motors at fixed quantity control with PID – Decreasing Demand

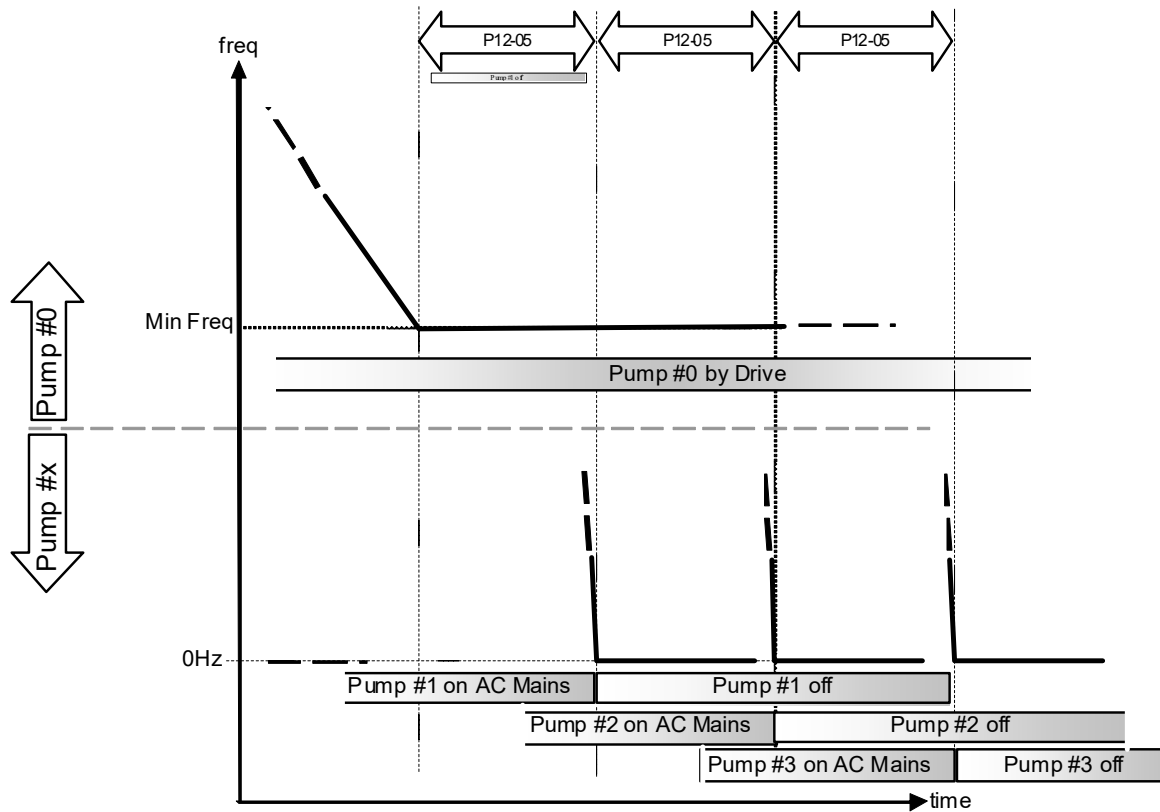

Diagram 12-10: Sequence of switching motors at fixed quantity control with PID – Decreasing Demand

Parameter Setting	Description																																																																																										
P12-00=3	Choose Fixed quantity control																																																																																										
P12-01=X	<p>Number of Motors: Maximum 8 motors. After setting number of motor to be connected at the same time, multi-function output terminals will follow automatically the setting as shown in the table below.</p> <table border="1"> <thead> <tr> <th>P12-01</th> <th>01</th> <th>02</th> <th>03</th> <th>04</th> <th>05</th> <th>06</th> <th>07</th> <th>08</th> <th></th> </tr> </thead> <tbody> <tr> <td>P02-13</td> <td>55</td> <td>55</td> <td>55</td> <td>55</td> <td>55</td> <td>55</td> <td>55</td> <td>55</td> <td>Motor #1 by Mains</td> </tr> <tr> <td>P02-14</td> <td></td> <td>56</td> <td>56</td> <td>56</td> <td>56</td> <td>56</td> <td>56</td> <td>56</td> <td>Motor #2 by Mains</td> </tr> <tr> <td>P02-15</td> <td></td> <td></td> <td>57</td> <td>57</td> <td>57</td> <td>57</td> <td>57</td> <td>57</td> <td>Motor #3 by Mains</td> </tr> <tr> <td>P02-36</td> <td></td> <td></td> <td></td> <td>58</td> <td>58</td> <td>58</td> <td>58</td> <td>58</td> <td>Motor #4 by Mains</td> </tr> <tr> <td>P02-37</td> <td></td> <td></td> <td></td> <td></td> <td>59</td> <td>59</td> <td>59</td> <td>59</td> <td>Motor #5 by Mains</td> </tr> <tr> <td>P02-38</td> <td></td> <td></td> <td></td> <td></td> <td></td> <td>60</td> <td>60</td> <td>60</td> <td>Motor #6 by Mains</td> </tr> <tr> <td>P02-39</td> <td></td> <td></td> <td></td> <td></td> <td></td> <td></td> <td>61</td> <td>61</td> <td>Motor #7 by Mains</td> </tr> <tr> <td>P02-40</td> <td></td> <td></td> <td></td> <td></td> <td></td> <td></td> <td></td> <td>62</td> <td>Motor #8 by Mains</td> </tr> </tbody> </table> <p>Table 2: Setting of Multi-function Output Terminal on Circulating Motors</p>	P12-01	01	02	03	04	05	06	07	08		P02-13	55	55	55	55	55	55	55	55	Motor #1 by Mains	P02-14		56	56	56	56	56	56	56	Motor #2 by Mains	P02-15			57	57	57	57	57	57	Motor #3 by Mains	P02-36				58	58	58	58	58	Motor #4 by Mains	P02-37					59	59	59	59	Motor #5 by Mains	P02-38						60	60	60	Motor #6 by Mains	P02-39							61	61	Motor #7 by Mains	P02-40								62	Motor #8 by Mains
P12-01	01	02	03	04	05	06	07	08																																																																																			
P02-13	55	55	55	55	55	55	55	55	Motor #1 by Mains																																																																																		
P02-14		56	56	56	56	56	56	56	Motor #2 by Mains																																																																																		
P02-15			57	57	57	57	57	57	Motor #3 by Mains																																																																																		
P02-36				58	58	58	58	58	Motor #4 by Mains																																																																																		
P02-37					59	59	59	59	Motor #5 by Mains																																																																																		
P02-38						60	60	60	Motor #6 by Mains																																																																																		
P02-39							61	61	Motor #7 by Mains																																																																																		
P02-40								62	Motor #8 by Mains																																																																																		
P12-05=X	Delay time while fixed quantity circulation at Motor Switching (seconds)																																																																																										
P12-06=X	Frequency when switching motors at fixed quantity circulation (Hz)																																																																																										

Disable Motor's Output

Set the Multifunction Input Commands as Disable Motors' Output can stop corresponding motors. The settings are: :

P02-01~P02-06=	60	61	62	63	64	65	66	67	68
Disable Motor's Output	ALL	1	2	3	4	5	6	7	8

When a motor's output is disabled, this motor will park freely

Wiring: Fixed Quantity Control can control up to 8 motors. The diagram 12-12 is an example of controlling 4 motors at the same time.

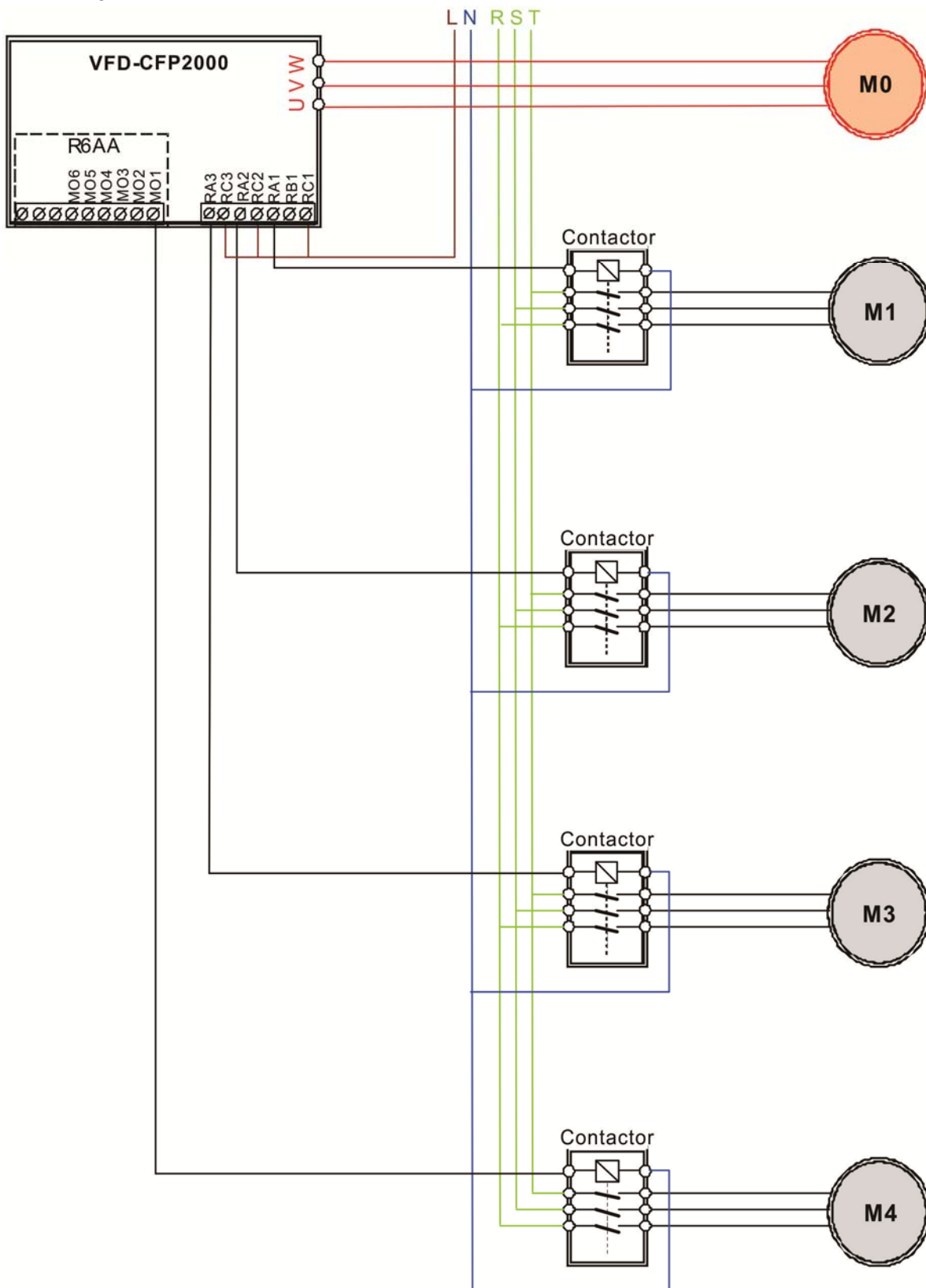

Diagram 12-12

📖 Fixed Time circulation and Fixed quantity circulation with PID

This mode combines Fixed Time circulation and fixed quantity circulation with PID. It is to prevent motors to become rusty if they are not in use for a long period of time. If some motors are not activated, set the fixed time circulation to run motors one by one to make sure each of them has the chance to run.

While all the motors are running and water pressure is enough, the time circulation will not be enabled. Suppose that motor1 and motor2 run to reach a balance in water pressure and when the time reaches the setting at Pr12-02, the motor1 will be running without using mains electricity and the motor2 will decelerate to stop.

When the motor2 reaches the frequency setting at Pr12-06 and the time setting at Pr12-05, it will be separating from the motor drive. Then when time reaches the setting at Pr12-03, the motor2 will run by using the mains electricity. Then when the time passes the setting at Pr12-03, the motor3 will be enabled by the motor drive. The time sequence diagram is as shown below.

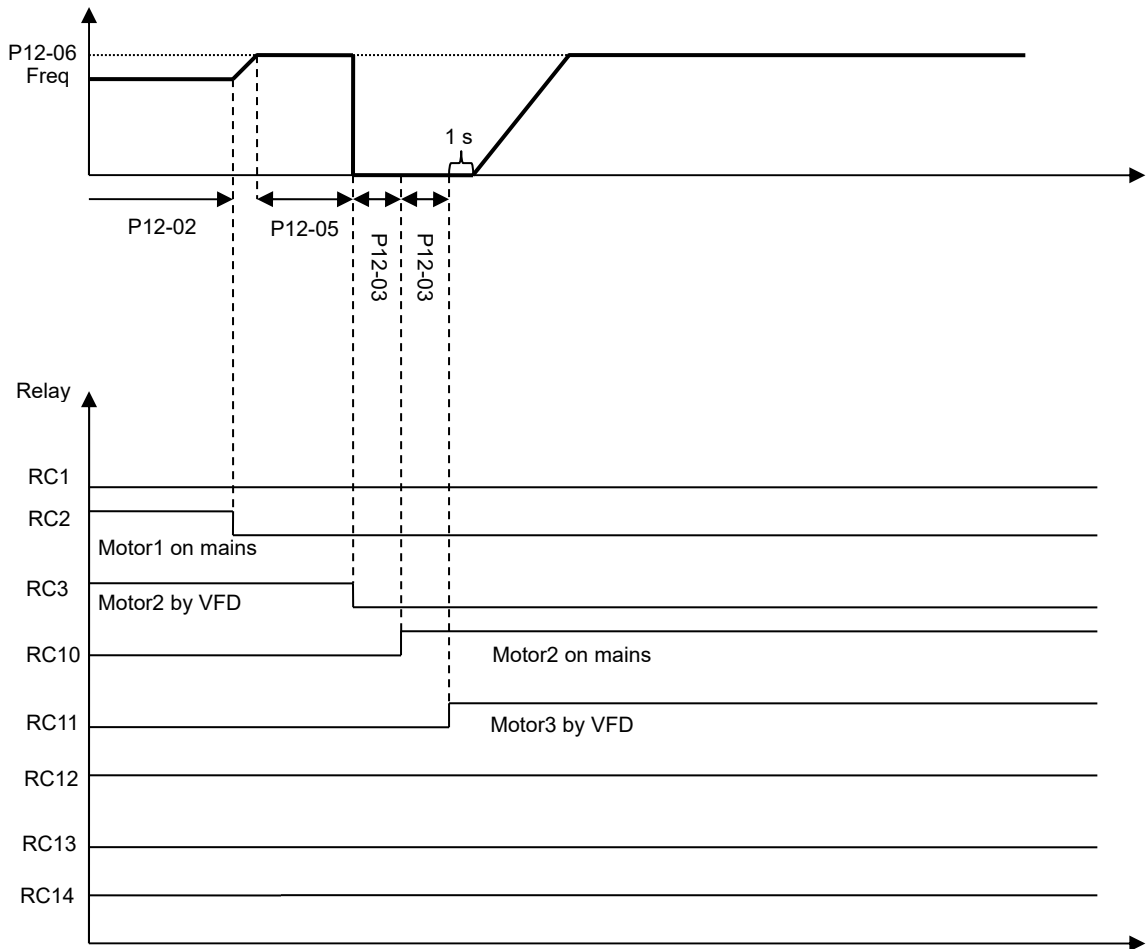

Fixed Time Circulation and Fixed Quantity Control with PID

 Time circulation and Fixed amount control with PID

This mode combines Fixed Time circulation and fixed quantity control with PID. It is to prevent motors to become rusty if they are not in use for a long period of time. If some motors are not activated, set the fixed time circulation to run motors one by one to make sure each of them has the chance to run.

When all the motors are running and water pressure is enough, the fixed time circulation will not be enabled. Suppose that the motor1 and motor2 run to reach a balance in water pressure and when time reach the setting at Pr12-02, the motor1 will be running without using mains electricity. Then when time reaches the setting at Pr12-03, the motor3 will be running by using mains electricity. At this moment, the operating time of each motor will be reset, once reach the time setting at Pr12-02 again, the motor2 will be running without using mains electricity. Then when time reaches the setting at Pr12-03, the fourth motor4 will be running by using mains electricity. The time sequence diagram 12-14 is as shown below

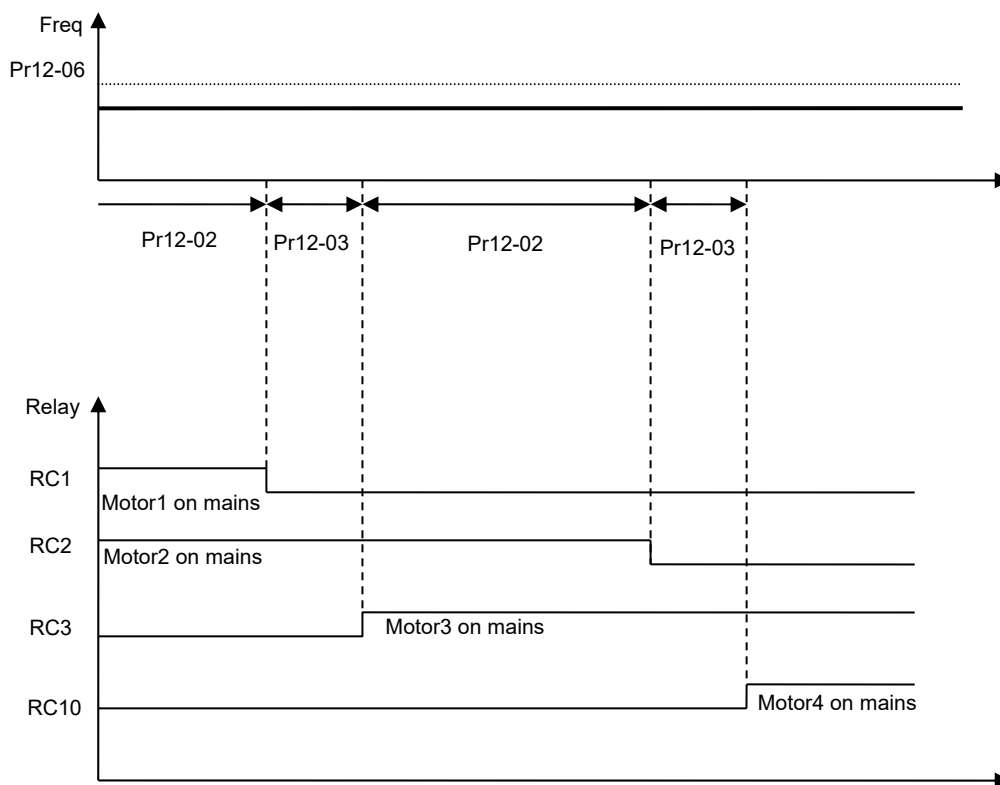

Diagram 12-14: Enabling Fixed Time Circulation under Fixed Amount Control Balance

13 Application Parameters by Industry

✎ This parameter can be set during operation.

13-00 Application selection

Factory Setting: 0

- Settings
- 0: Disabled
 - 1: User Parameter
 - 2: Compressor IM
 - 3: Fan
 - 4: Pump
 - 10: Air Handling Unit(AHU)

 In parameter group13, the related paramters and settings will be brought up automatically when the application is selected.

 Each setting varies with different application selection, its value will be different as well.

 See Chapter 10-2 for more operation details.

 Settings:

2: Compressor IM

The following table describes the use of parameters for the relevant compressor application.

Pr.	Explanation	Settings
00-11	Control of Speed Mode	0: VF (IM V/F control)
00-16	Duty Selection	0: Light duty
00-17	Carrier Frequency	Factory default setting
00-20	Source of Master Frequency Command (AUTO)	2: External analog input (Pr.03-00)
00-21	Source of the Operation Command (AUTO)	1: External terminals. Keypad STOP disabled.
00-22	Stop Method	0: Ramp to stop
00-23	Control of Motor Direction	1: Reverse disable
01-00	Max. Operation Frequency	Factory default setting
01-01	Output Frequency of Motor 1	Factory default setting
01-02	Output Voltage of Motor 1	Factory default setting
01-03	Mid-point Frequency 1 of Motor 1	Factory default setting
01-04	Mid-point Voltage 1 of Motor 1	Factory default setting
01-05	Mid-point Frequency 2 of Motor 1	Factory default setting
01-06	Mid-point Voltage 2 of Motor 1	Factory default setting
01-07	Min. Output Frequency of Motor 1	Factory default setting
01-08	Min. Output Voltage of Motor 1	Factory default setting
01-11	Output Frequency Lower Limit	20 (Hz)
01-12	Accel. Time 1	20 (s)
01-13	Decel Time 1	20 (s)
03-00	Analog Input Selection (AVI1)	0: No function
03-01	Analog Input Selection (ACI)	1: Frequency command (speed limit under torque control mode)
05-01	Full-load Current of Induction Motor 1(A)	Factory default setting

Pr.	Explanation	Settings
05-03	Rated Speed of Induction Motor 1 (rpm)	Factory default setting
05-04	Pole Number of Induction Motor 1	Factory default setting

3: Fan

The following table describes the use of parameters for the relevant fan application.

Pr.	Explanation	Settings
00-11	Control of Speed Mode	0 (VF)
00-16	Duty Selection	0: Light duty
00-17	Carrier Frequency	Factory default setting
00-20	Source of Master Frequency Command (AUTO)	2: External analog input (Pr.03-00)
00-21	Source of the Operation Command (AUTO)	1: External terminals. Keypad STOP disabled.
00-22	Stop Method	1: Coast to stop
00-23	Control of Motor Direction	1: Reverse disable
00-30	Source of the Master Frequency Command (HAND)	0: Digital keypad
00-31	Source of the Operation Command (HAND)	0: Digital keypad
01-00	Max. Operation Frequency	Factory default setting
01-01	Output Frequency of Motor 1	Factory default setting
01-02	Output Voltage of Motor 1	Factory default setting
01-03	Mid-point Frequency 1 of Motor 1	Factory default setting
01-04	Mid-point Voltage 1 of Motor 1	Factory default setting
01-05	Mid-point Frequency 2 of Motor 1	Factory default setting
01-06	Mid-point Voltage 2 of Motor 1	Factory default setting
01-07	Min. Output Frequency of Motor 1	Factory default setting
01-08	Min. Output Voltage of Motor 1	Factory default setting
01-10	Output Frequency Upper Limit	50 (Hz)
01-11	Output Frequency Lower Limit	35 (Hz)
01-12	Accel. Time 1	15 (s)
01-13	Decel Time 1	15 (s)
01-43	V/F Curve Selection	2: 2 nd V/F curve
02-05	Multi-function Input Command 5 (MI5)	16: Operation speed command from ACI
03-00	Analog Input Selection (AVI1)	1: Frequency command (speed limit under torque control mode)
03-01	Analog Input Selection (ACI)	1: Frequency command (speed limit under torque control mode)
03-28	AVI1 Selection	0 (0~10 V)
03-29	ACI Selection	1 (0~10 V)
03-31	AFM2 Output Selection	0 (0~10 V)
03-50	Analog Input Curve Selection	1: 3 point curve of AVI1
07-06	Restart after Momentary Power Loss	2: Speed search for minimum output frequency
07-11	Number of Times of Auto Restart After Fault	5

Pr.	Explanation	Settings
07-33	Auto restart interval of Fault	60 (s)

4: Pump

The following table describes the use of parameters for the relevant pump application.

Pr.	Explanation	Settings
00-11	Control of Speed Mode	0 (VF)
00-16	Duty Selection	0: Light duty
00-20	Source of Master Frequency Command (AUTO)	2: External analog input (Pr.03-00)
00-21	Source of the Operation Command (AUTO)	1: External terminals. Keypad STOP disabled.
00-23	Control of Motor Direction	1: Reverse disable
01-00	Max. Operation Frequency	Factory default setting
01-01	Output Frequency of Motor 1	Factory default setting
01-02	Output Voltage of Motor 1	Factory default setting
01-03	Mid-point Frequency 1 of Motor 1	Factory default setting
01-04	Mid-point Voltage 1 of Motor 1	Factory default setting
01-05	Mid-point Frequency 2 of Motor 1	Factory default setting
01-06	Mid-point Voltage 2 of Motor 1	Factory default setting
01-07	Min. Output Frequency of Motor 1	Factory default setting
01-08	Min. Output Voltage of Motor 1	Factory default setting
01-10	Output Frequency Upper Limit	50 (Hz)
01-11	Output Frequency Lower Limit	35 (Hz)
01-12	Accel. Time 1	15 (s)
01-13	Decel Time 1	15 (s)
01-43	V/F Curve Selection	2: 2 nd V/F curve
07-06	Restart after Momentary Power Loss	2: Speed search for minimum output frequency
07-11	Number of Times of Auto Restart After Fault	5
07-33	Auto restart interval of Fault	60 (s)

10: Air Handling Unit (AHU)

The following table describes the use of parameters for the relevant AHU application.

Pr.	Explanation	Settings
00-04	Multi-function Display	2
00-11	Control of speed mode	0 (V/F)
00-16	Duty selection	0: Light duty
00-20	Source of Master Frequency Command (AUTO)	2 (External analog input)
00-21	Source of the operation command (AUTO)	1 (External terminals)
00-22	Stop Method	1 (Coast to stop)
00-23	Control of motor direction	1 (Disable reverse)
00-30	Source of the Master Frequency Command (HAND)	0

Pr.	Explanation	Settings
00-31	Source of the Operation Command (HAND)	0
01-00	Max. operation frequency of motor 1	Factory default setting
01-01	Output frequency of motor 1	Factory default setting
01-02	Output voltage of motor 1	Factory default setting
01-07	Min. output frequency of motor 1	Factory default setting
01-10	Output frequency upper limit	50 (Hz)
01-11	Output frequency lower limit	35 (Hz)
01-34	Zero-speed Mode	2
01-43	V/F curve selection	2 (2 nd V/F curve)
02-05	Multi-function Input Command 5 (MI5)	16 or 17
02-13	Relay1: Multi Output Terminal	11
02-14	Relay2: Multi Output Terminal	1
03-00	Analog Input 1 (AVI1)	1
03-01	Analog Input 2(ACI)	1
03-02	Analog Input 3 (AVI2)	1
03-28	AVI1 Selection	0
03-29	ACI Selection	1
03-20	Multi-function Output 1 (AFM1)	0
03-23	Multi-function Output 2 (AFM2)	0
03-31	AFM2 0~20mA Output Selection	0 or 1
03-34	AFM1 0~20mA Output Selection	0 or 1
03-50	Analog Calculation Selection	4
07-06	Restart after momentary power loss	2 (Speed tracking by minimum output frequency)
07-11	Restart times after fault	5 (times)
07-33	Return Time of Fault Restart	60 (s)

13-01

~

Application Parameter 1~99

13-99

Factory Setting: 0.00

Settings 0.00~655.35

12-2 Adjustment & Application

Standard PM Motor Adjustment Procedure

- Pr00-11=2 SVC

Flow chart of adjustment when starting up WITHOUT load

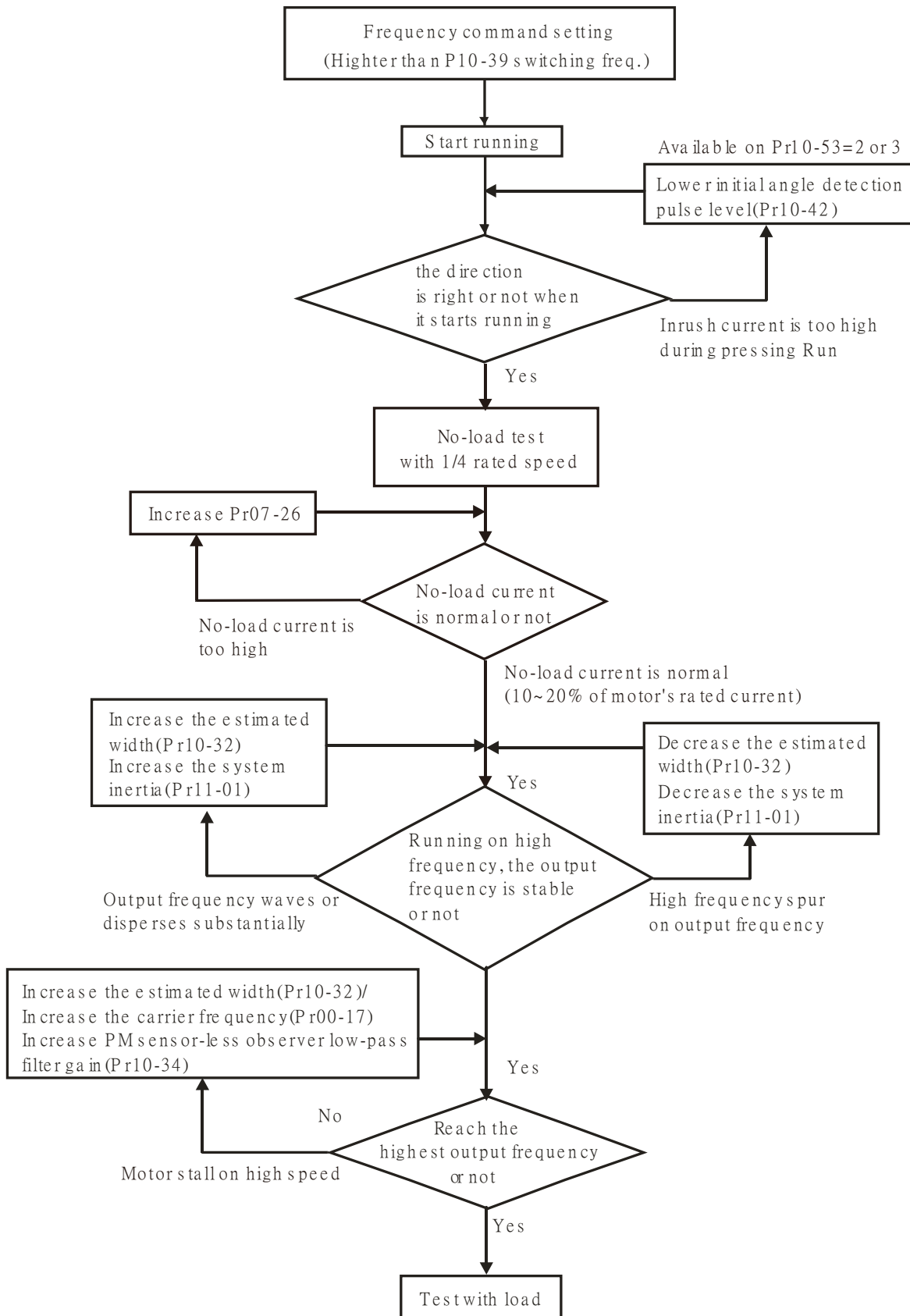

Flow chart of adjustment when starting up WITH load

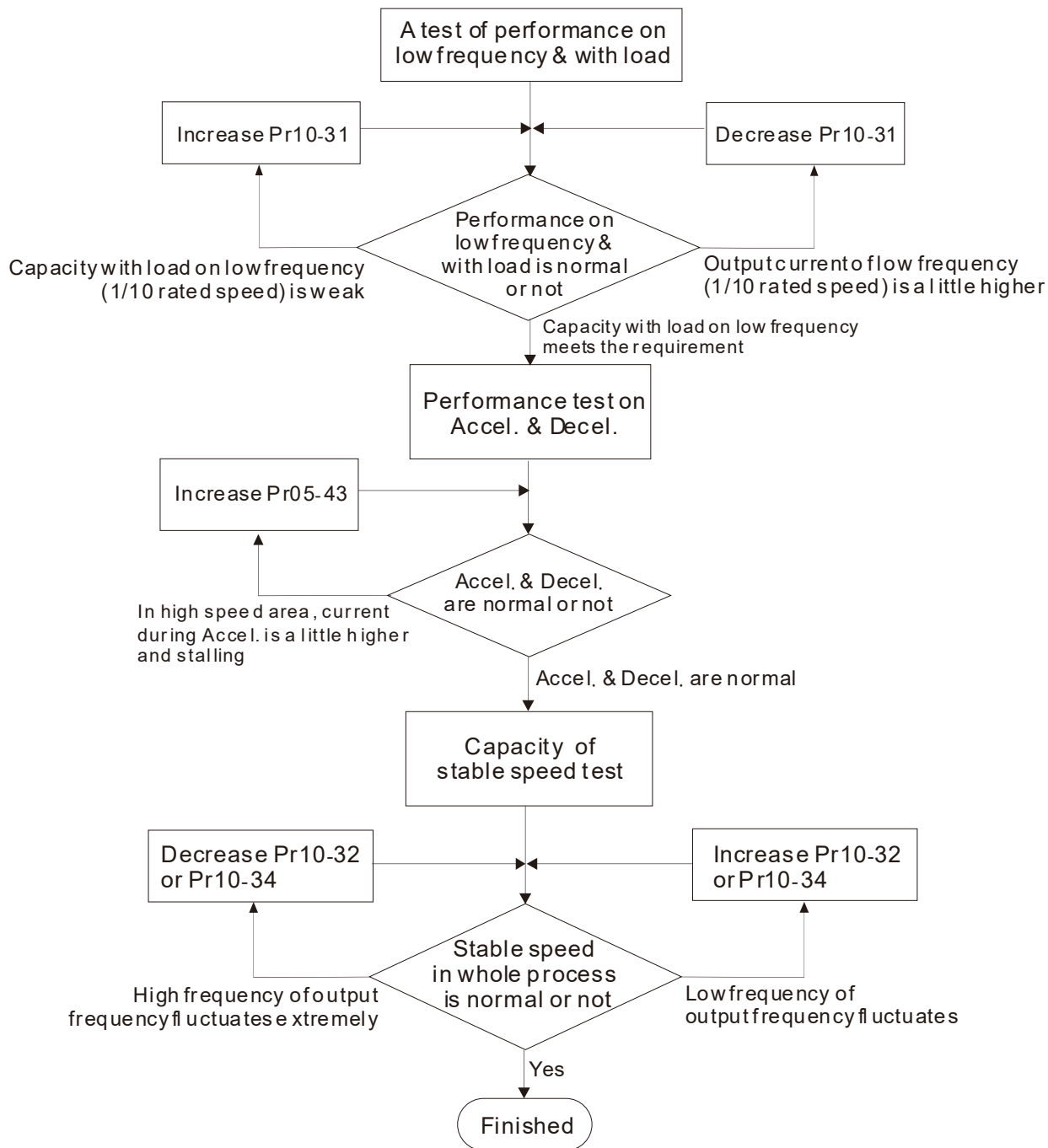

PMSVC control diagram

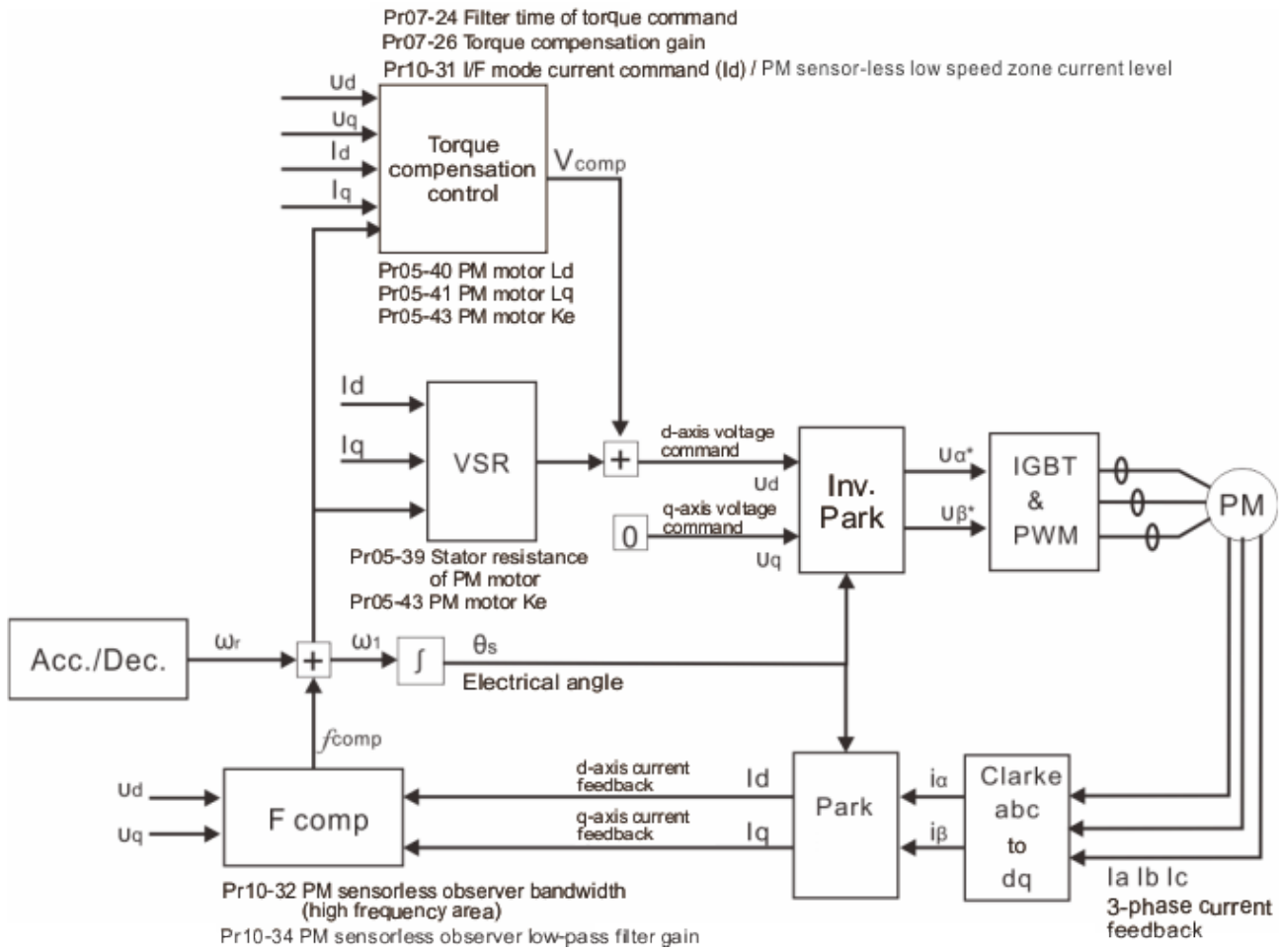

Adjustment procedure

1. Set up PM motor control
 - Pr05-33=1 or 2
2. Set up motor parameter according to the nameplate on the motor
 - Pr01-01 Output Frequency of Motor 1 (base frequency and motor rated frequency)
 - Pr01-02 Output Voltage of Motor 1 (base frequency and motor rated frequency)
 - Pr05-34 Full-load current of Permanent Magnet Motor
 - Pr05-35 Rated Power of Permanent Magnet Motor
 - Pr05-36 Rated speed of Permanent Magnet Motor
 - Pr05-37 Pole number of Permanent Magnet Motor

3. Execute Auto-tuning

05-00 Motor Auto Tuning

Factory Setting: 0

- Settings
- 0: No function
 - 1: Rolling test for induction motor(IM) (R_s, R_r, L_m, L_x , no-load current) [motor running]
 - 2: Static test for induction motor [motor not running]
 - 3~12: No function
 - 13: Static test for PM motor

- 📖 Set up Pr05-00=13 for PM motor tuning and press Run (static-tuning). When the tuning is done, the following parameters will be obtained.

Pr05-39 Stator Resistance of PM Motor

Pr05-40 Permanent Magnet Motor Ld

Pr05-41 Permanent Magnet Motor Lq

Pr05-43 (V/1000rpm), the Ke parameter of PM motor (this can be calculated automatically according to power, current and speed of motor).

Pr10-52 Injection magnitude

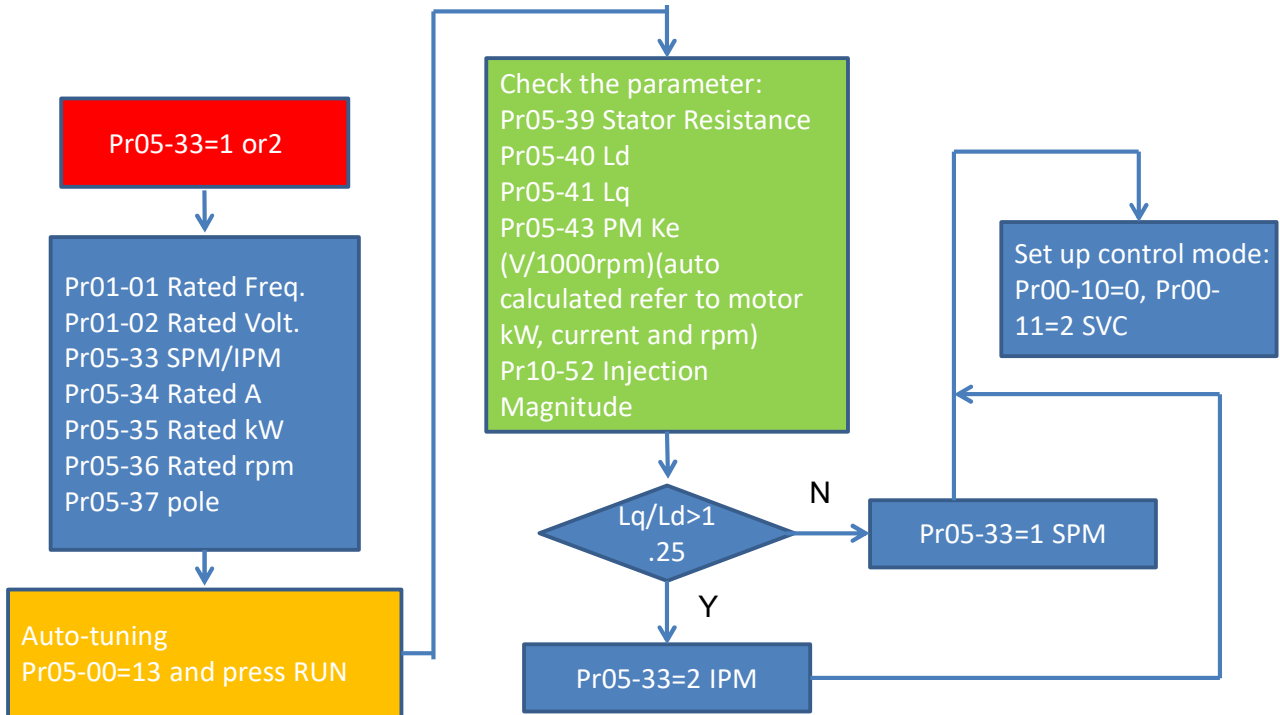

4. Set up speed control mode: Pr00-10=0, Pr00-11=2 SVC.
5. It is suggested that cutting off the power after finishing tuning, and then re-power on.
6. The ration of PMSVC control mode is 1:20.
7. When PMSVC control mode is under 1/20 rated speed, load bearing capacity=100% motor rated torque.
8. PMSVC control mode is not applicable for zero speed control.
9. Start-up with load and forward/reverse load bearing capacity of PMSVC control mode=100% rated torque of motor.
10. Set up the speed estimators related parameters

↗ **10-31** I/F Mode Current Command / Low-speed Current Command under PMSVC Control

Factory Setting:40

Settings 0~150% of motor's rated current

- 📖 The parameter is the current reference level of the drive in low-speed zone (low-speed zone: frequency command < Pr10-39).
- 📖 When it is stalling on heavy duty start-up or forward/reverse with load, adjust the parameter (to increase it). If inrush current too high to cause oc stall, then decrease it.

10-32 High-speed Estimator Bandwidth

Factory Setting:5.00

Settings 0.00~600.00Hz

- 📖 The parameter is high-speed estimator bandwidth. Adjust the parameter will influence the stability and the accuracy of speed for motor.
- 📖 If there is low frequency vibrates (the waveform is similar to sine wave) during the process, then increase the bandwidth. If there is high frequency vibrates (the waveform vibrates extremely and is like spur), then decrease the bandwidth.

10-34 Estimate frequency filter time

Factory Setting:1.00

Settings 0.00~655.35

- 📖 Adjust the parameter will influence the speed estimator's speed of response.
- 📖 If there is low frequency vibrates (the waveform is similar to sine wave) during the process, then increase the gain. If there is high frequency vibrates (the waveform vibrates extremely and is like spur), then decrease the gain.

10-39 Frequency Point when switch from I/F Mode to PM Sensorless Mode

Factory Setting:20.00

Settings 0.00~599.00Hz

- 📖 The parameter is the switch point, which is from low frequency to high frequency. It will influence high/low frequency area of speed observer.
- 📖 If the switch point is too low, motor could not generate enough back emf for the speed estimator to measure the right rotator's position and speed, and cause stall and over current when the frequency of switch point is running.
- 📖 If the switch point is too high, the active area of I/F will be too wide, and then it will generate larger current to make it cannot save energy. (The reason is that if the current of Pr10-31 sets too high, and the high switch point will make the drive keeps outputting with the setting value of Pr10-31)

10-42 Initial Angle Detection Pulse Level

Factory Setting:10

Settings 0.0~3.0 times of motor rated current

- 📖 This parameter is only available when the Pr10-53=2 or 3.
- 📖 The parameter influences the value of pulse during the angle detection. The larger the pulse is, the higher of the accuracy of rotator's position reaches. But it might cause an over-current trip up more easily.
- 📖 Increase the parameter when the running direction and the command are opposite while start-up. If over-current occurs in the start-up moment, then decrease the parameter.



10-49 Zero voltage time while start up

Factory Setting: 0.000

Settings 0.000~60.000 sec.

- 📖 When the motor is in static status at the startup, the accuracy to estimate angles will be



increased. In order to make the motor in “static status”, the drive 3 phase U, V, W output 0V to motor to reach this goal. The Pr10-49 setting time is the length of time when three-phase output 0V.

-  It is possible that even when this parameter is being applied but the motor at the installation site cannot go in to the “static status” caused by the inertia or by any external force. So, if the motor doesn't go into a complete “static status” in 0.2 sec, increase appropriately this setting value.
-  This parameter is functional only when the setting of Pr07-12 Speed Search during Startup $\neq 0$.
-  If Pr10-49 sets too high, the start-up time will be longer obviously. If is too low, then the braking performance will be weak.

10-51 Injection Frequency

Factory Setting: 500Hz





Settings 0~1200Hz

-  This parameter is a High Frequency Injection Command when the motor drive is under PMSVC control mode and it doesn't often need to be adjusted. But, if a motor's rated frequency (i.e. 400Hz) is too close to the frequency setting of this parameter (i.e. 500Hz), the accuracy of angles detected will be affected. Therefore, refer to the setting of Pr01-01 before adjusting this parameter.
-  If the setting value of Pr00-17 is lower than 10 times of Pr.10-51, then increase the frequency of carrier wave.
-  Parameter 10-51 is valid only when the parameter 10-53=2.

10-52 Injection Magnitude

Factory Setting: 15/30V

Settings 0.0~200.0V

-  The parameter is magnitude command of high frequency injection signal when the motor drive is under PMSVC control mode.
-  Increase the parameter can get more accurate estimated value of angle. But the noise of electromagnetic might be louder if the setting value is too high.
-  The setting value of this parameter will be received automatically when the motor parameter is auto-tuning. And the parameter will influence the accuracy of angel's estimation.
-  When the ratio of salient pole (Lq/Ld) is lower, increase Pr10-52 to make angle detection be accurate.

10-53 PM Motor Initial Rotor Position Detection Method

Factory Setting: 0

Settings

- 0: No function
- 1: DC injection
- 2: High frequency injection
- 3: Pulse injection
- 4~5: Reserved



-  It is suggested to set as “2” if it's IPM; set as “3” if it's SPM. If there is bad effect when set as “2” or “3”, then set as “1”.

11. Parameters for speed adjustment

↘ **07-26** Torque Compensation Gain (V/F and SVC control mode)

Factory Setting: 0

Settings 0~10

-  The parameter influences the output current during the running process. There will be less effect on the low speed area.
-  Increase the setting value if the current with no-load is too high. But it might also cause the motor to vibrate. If the motor vibrates during the operation, decrease the setting value.

Chapter 13 Warning Codes

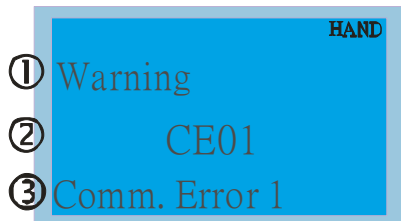

① Warning

② CE01

③ Comm. Error 1





① Display error signal

② Abbreviate error code

③ Display error description

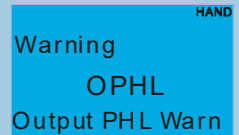
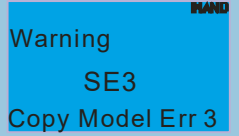
ID No.	Display on LCM Keypad	Descriptions
1		RS485 Modbus function code error
2		RS485 Address of Modbus data error
3		RS485 Modbus data error
4		RS485 Modbus communication error
5		RS485 Modbus transmission time-out
6		Keypad transmission time-out
7		Keypad COPY error 1 Keypad simulation error, including communication delays, communication error (keypad received error FF86) and parameter value error.
8		Keypad COPY error 2 Keypad simulation done, parameter write error
9		IGBT over-heating warning

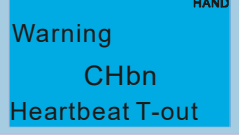
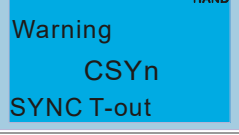
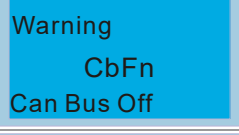
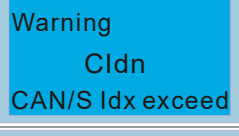
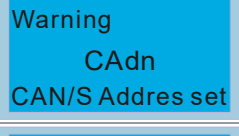
ID No.	Display on LCM Keypad	Descriptions
10		Capacity over-heating warning
11		PID feedback error
12		ACI signal error When Pr03-19 is set to 1 and 2.
13		Low current
14		Auto tuning error
19		Phase loss
20		Over torque 1
21		Over torque 2
22		Motor over-heating
23		Current control
24		Over slip
25		Auto tuning processing

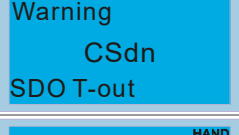
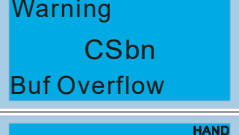
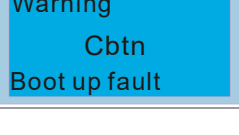
ID No.	Display on LCM Keypad	Descriptions
28	 <p>Warning OPHL Output PHL Warn</p>	Output phase loss
30	 <p>Warning SE3 Copy Model Err 3</p>	Keypad COPY error 3 Keypad copy between different power range drive
36	 <p>Warning CGdn Guarding T-out</p>	CAN guarding time-out 1
37	 <p>Warning CHbn Heartbeat T-out</p>	CAN heartbeat time-out 2
38	 <p>Warning CSYn SYNC T-out</p>	CAN synchrony time-out
39	 <p>Warning CbFn Can Bus Off</p>	CAN bus off
40	 <p>Warning CIdn CAN/S Idx exceed</p>	CAN index error
41	 <p>Warning CAdn CAN/S Address set</p>	CAN station address error
42	 <p>Warning CFrn CAN/S FRAM fail</p>	CAN memory error
43	 <p>Warning CSdn SDO T-out</p>	CAN SDO transmission time-out
44	 <p>Warning CSbn Buf Overflow</p>	CAN SDO received register overflow
45	 <p>Warning Cbtn Boot up fault</p>	CAN boot up error

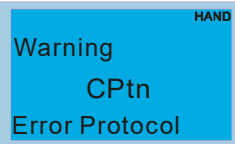
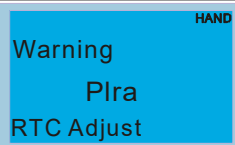
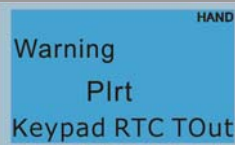
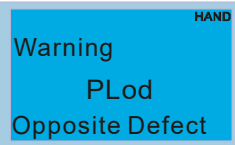
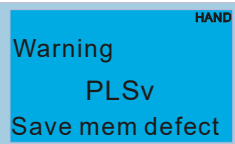
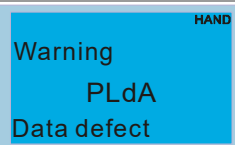
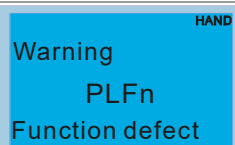
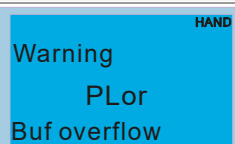
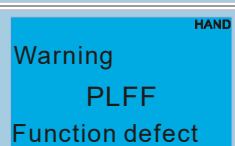
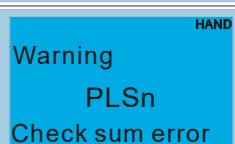
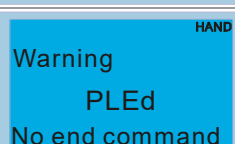
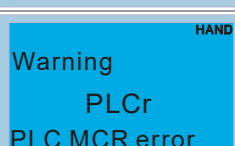
ID No.	Display on LCM Keypad	Descriptions
46		CAN format error
47		Adjust RTC
49		Keypad RTC time-out
50		PLC download error
51		Save error of PLC download
52		Data error during PLC operation
53		Function code of PLC download error
54		PLC register overflow
55		Function code of PLC operation error
56		PLC checksum error
57		PLC end command is missing
58		PLC MCR command error

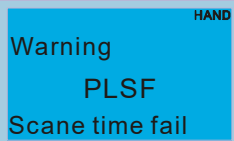
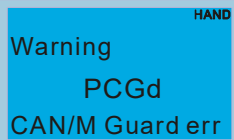
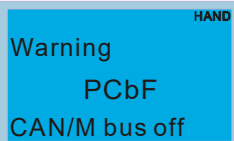
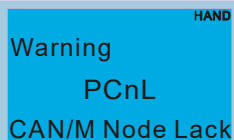
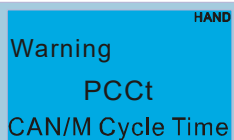
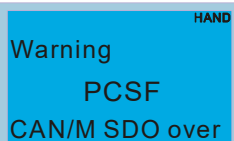
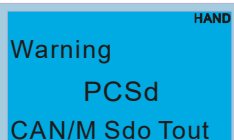
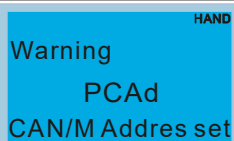
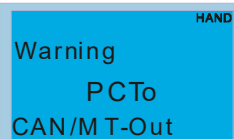
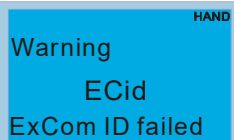
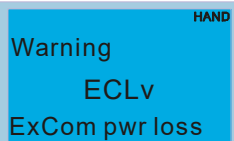
ID No.	Display on LCM Keypad	Descriptions
59	 <p>Warning PLdF Download fail</p>	PLC download fail
60	 <p>Warning PLSF Scane time fail</p>	PLC scan time exceed
61	 <p>Warning PCGd CAN/M Guard err</p>	CAN Master guarding error
62	 <p>Warning PCbF CAN/M bus off</p>	CAN Master bus off
63	 <p>Warning PCnL CAN/M Node Lack</p>	CAN Master node error
64	 <p>Warning PCct CAN/M Cycle Time</p>	CAN / M cycle time-out
65	 <p>Warning PCSF CAN/M SDO over</p>	CAN/M SDOover
66	 <p>Warning PCsd CAN/M Sdo Tout</p>	CAN/M SDO time-out
67	 <p>Warning PCAd CAN/M Adres set</p>	CAN / M station address error
68	 <p>Warning PCTo CAN/M T-Out</p>	PLC / CAN Master Slave communication time out
70	 <p>Warning ECid ExCom ID failed</p>	Duplicate MAC ID error Node address setting error
71	 <p>Warning ECLv ExCom pwr loss</p>	Low voltage of communication card

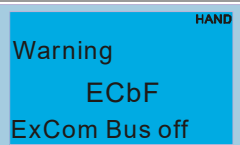
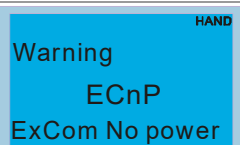
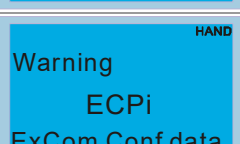
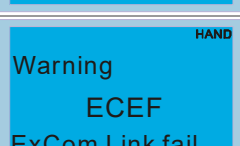
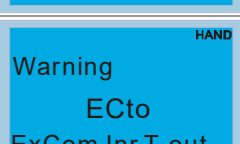
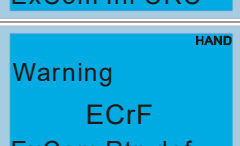
ID No.	Display on LCM Keypad	Descriptions
72	 <p>Warning ECtt ExCom Test Mode</p>	Communication card in test mode
73	 <p>Warning ECbF ExCom Bus off</p>	DeviceNet bus-off
74	 <p>Warning ECnP ExCom No power</p>	DeviceNet no power
75	 <p>Warning ECFF ExCom Factory def</p>	Factory default setting error
76	 <p>Warning ECiF ExCom Inner err</p>	Serious internal error
77	 <p>Warning ECio ExCom IONet brk</p>	I/O connection break off
78	 <p>Warning ECPD ExCom Pr data</p>	Profibus parameter data error
79	 <p>Warning ECPi ExCom Conf data</p>	Profibus configuration data error
80	 <p>Warning ECEF ExCom Link fail</p>	Ethernet Link fail
81	 <p>Warning ECto ExCom Inr T-out</p>	Communication time-out for communication card and drive
82	 <p>Warning ECCS ExCom Inr CRC</p>	Check sum error for Communication card and drive
83	 <p>Warning ECrF ExCom Rtn def</p>	Communication card returns to default setting

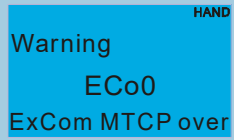
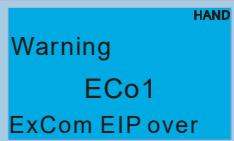
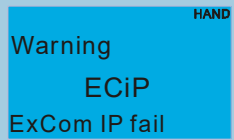
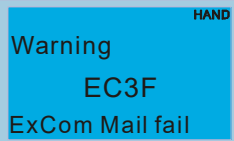
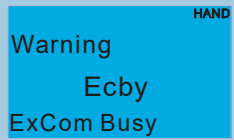
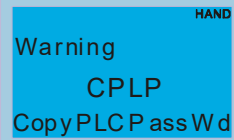
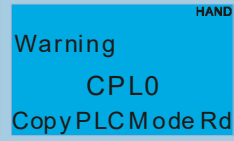
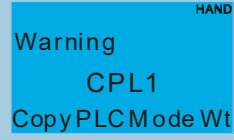
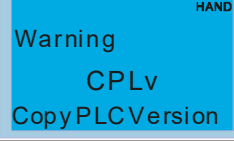
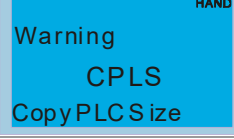
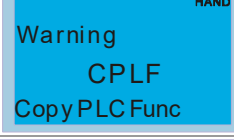
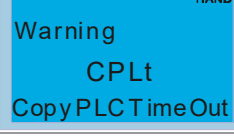
ID No.	Display on LCM Keypad	Descriptions
84	 <p>Warning ECo0 ExCom MTCP over</p>	Modbus TCP exceed maximum communication value
85	 <p>Warning ECo1 ExCom EIP over</p>	EtherNet / IP exceed maximum communication value
86	 <p>Warning ECiP ExCom IP fail</p>	IP fail
87	 <p>Warning EC3F ExCom Mail fail</p>	Mail fail
88	 <p>Warning Ecby ExCom Busy</p>	Communication card busy
90	 <p>Warning CPLP CopyPLCP assWd</p>	Copy PLC password error
91	 <p>Warning CPL0 CopyPLCMode Rd</p>	Copy PLC Read mode error
92	 <p>Warning CPL1 CopyPLCMode Wt</p>	Copy PLC Write mode error
93	 <p>Warning CPLv CopyPLCVersion</p>	Copy PLC Version error
94	 <p>Warning CPLS CopyPLCSize</p>	Copy PLC Capacity size error
95	 <p>Warning CPLF CopyPLCFunc</p>	Copy PLC: PLC can only be copied when PLC function is OFF
96	 <p>Warning CPLt CopyPLCTimeOut</p>	Copy PLC time out

ID No.	Display on LCM Keypad	Descriptions
101		Internal communication is off

Chapter 14 Fault Codes and Descriptions

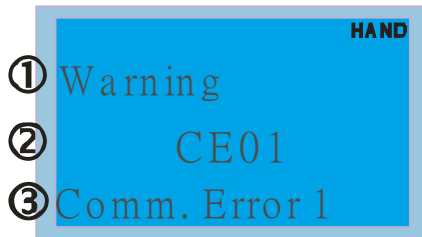

- ① Warning
- ② CE01
- ③ Comm. Error 1

- ① Display error signal
- ② Abbreviate error code
- ③ Display error description

* Refer to setting of Pr06-17~Pr06~22.

ID*	Fault Name	Fault Descriptions	Corrective Actions
1	<p>Fault ocA Oc at accel</p>	Over-current during acceleration (Output current exceeds 2.4 rated current during acceleration.)	<ol style="list-style-type: none"> 1. Short-circuit at motor output: Check for possible poor insulation at the output. 2. Acceleration Time too short: Increase the Acceleration Time. 3. AC motor drive output power is too small: Replace the AC motor drive with the next higher power model.
2	<p>Fault ocd Oc at decel</p>	Over-current during deceleration (Output current exceeds 2.4 rated current during deceleration.)	<ol style="list-style-type: none"> 1. Short-circuit at motor output: Check for possible poor insulation at the output. 2. Deceleration Time too short: Increase the Deceleration Time. 3. AC motor drive output power is too small: Replace the AC motor drive with the next higher power model.
3	<p>Fault ocn Oc at normal SPD</p>	Over-current during steady state operation (Output current exceeds 2.4 rated current during constant speed.)	<ol style="list-style-type: none"> 1. Short-circuit at motor output: Check for possible poor insulation at the output. 2. Sudden increase in motor loading: Check for possible motor stall. 3. AC motor drive output power is too small: Replace the AC motor drive with the next higher power model.
4	<p>Fault GFF Ground fault</p>	Ground fault	<p>When (one of) the output terminal(s) is grounded, short circuit current is more than 50% of AC motor drive rated current, the AC motor drive power module may be damaged.</p> <p>NOTE: The short circuit protection is provided for AC motor drive protection, not for protecting the user.</p> <ol style="list-style-type: none"> 1. Check the wiring connections between the AC motor drive and motor for possible short circuits, also to ground. 2. Check whether the IGBT power module is damaged. 3. Check for possible poor insulation at the output.
5	<p>Fault occ Short Circuit</p>	Short-circuit is detected between upper bridge and lower bridge of the IGBT module	Return to the factory

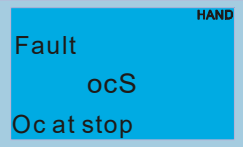
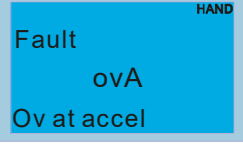
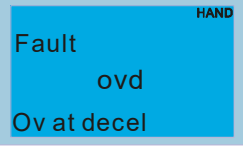
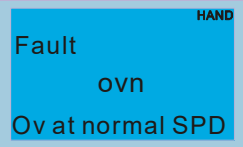
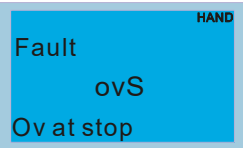
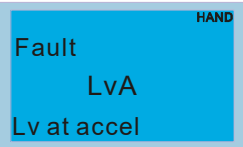
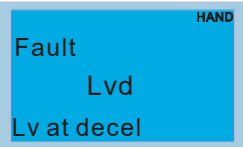
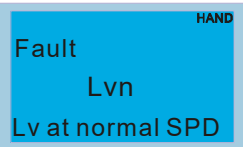
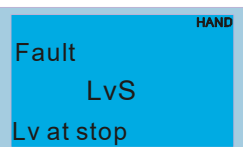
ID*	Fault Name	Fault Descriptions	Corrective Actions
6		Hardware failure in current detection	Return to the factory
7		DC BUS over-voltage during acceleration (460V: DC 820V)	<ol style="list-style-type: none"> 1. Check if the input voltage falls within the rated AC motor drive input voltage range. 2. Check for possible voltage transients. 3. If DC BUS over-voltage due to regenerative voltage, please increase the acceleration time or add an optional brake resistor.
8		DC BUS over-voltage during deceleration (460V: DC 820V)	<ol style="list-style-type: none"> 1. Check if the input voltage falls within the rated AC motor drive input voltage range. 2. Check for possible voltage transients. 3. If DC BUS over-voltage due to regenerative voltage, please increase the Deceleration Time or add an optional brake resistor.
9		DC BUS over-voltage at constant speed (460V: DC 820V)	<ol style="list-style-type: none"> 1. Check if the input voltage falls within the rated AC motor drive input voltage range. 2. Check for possible voltage transients. 3. If DC BUS over-voltage due to regenerative voltage, please increase the Deceleration Time or add an optional brake resistor.
10		Hardware failure in voltage detection	<ol style="list-style-type: none"> 1. Check if the input voltage falls within the rated AC motor drive input voltage range. 2. Check for possible voltage transients.
11		DC BUS voltage is less than Pr.06-00 during acceleration	<ol style="list-style-type: none"> 1. Check if the input voltage is normal 2. Check for possible sudden load 3. Adjust setting of Pr.06-00
12		DC BUS voltage is less than Pr.06-00 during deceleration	<ol style="list-style-type: none"> 1. Check if the input voltage is normal 2. Check for possible sudden load 3. Adjust setting of Pr.06-00
13		DC BUS voltage is less than Pr.06-00 in constant speed	<ol style="list-style-type: none"> 1. Check if the input voltage is normal 2. Check for possible sudden load 3. Adjust setting of Pr.06-00
14		DC BUS voltage is less than Pr.06-00 at stop	<ol style="list-style-type: none"> 1. Check if the input voltage is normal 2. Check for possible sudden load 3. Adjust setting of Pr.06-00

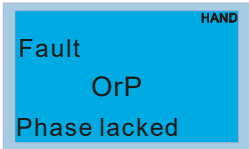
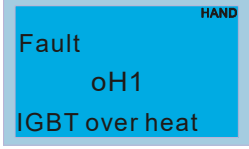
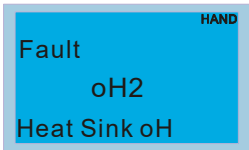
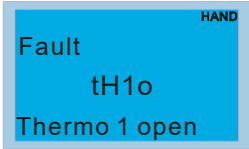
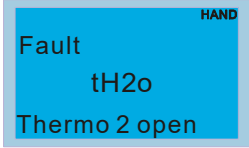
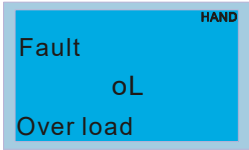
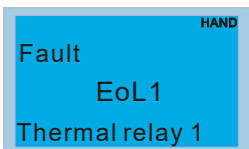
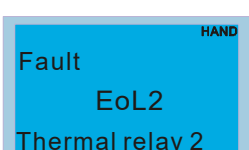
ID*	Fault Name	Fault Descriptions	Corrective Actions
15	 Fault OrP Phase lacked	Phase Loss	Check Power Source Input if all 3 input phases are connected without loose contacts. For models 40hp and above, please check if the fuse for the AC input circuit is blown.
16	 Fault oH1 IGBT over heat	IGBT overheating IGBT temperature exceeds protection level	<ol style="list-style-type: none"> 1. Ensure that the ambient temperature falls within the specified temperature range. 2. Make sure that the ventilation holes are not obstructed. 3. Remove any foreign objects from the heatsinks and check for possible dirty heat sink fans. 4. Check the fan and clean it. 5. Provide enough spacing for adequate ventilation.
17	 Fault oH2 Heat Sink oH	Heatsink overheating capacitance temperature exceeds cause heatsink overheating.	<ol style="list-style-type: none"> 1. Ensure that the ambient temperature falls within the specified temperature range. 2. Make sure heat sink is not obstructed. Check if the fan is operating 3. Check if there is enough ventilation clearance for AC motor drive.
18	 Fault tH1o Thermo 1 open	IGBT Hardware Error	Return to the factory
19	 Fault tH2o Thermo 2 open	Capacitor Hardware Error	Return to the factory
21	 Fault oL Over load	Overload The AC motor drive detects excessive drive output current.	<ol style="list-style-type: none"> 1. Check if the motor is overloaded. 2. Take the next higher power AC motor drive model.
22	 Fault EoL1 Thermal relay 1	Electronics thermal relay 1 protection	<ol style="list-style-type: none"> 1. Check the setting of electronics thermal relay (Pr.06-13~06-14) 2. Take the next higher power AC motor drive model
23	 Fault EoL2 Thermal relay 2	Electronics thermal relay 2 protection	<ol style="list-style-type: none"> 1. Check the setting of electronics thermal relay (Pr.06-27~06-28) 2. Take the next higher power AC motor drive model

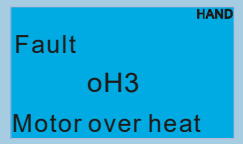
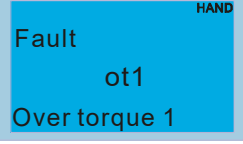
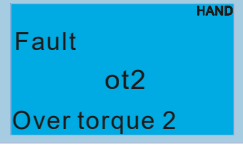
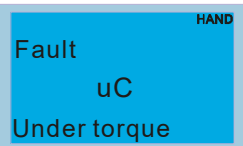
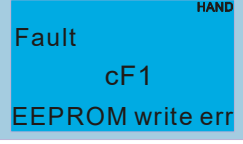
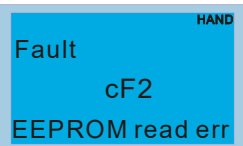
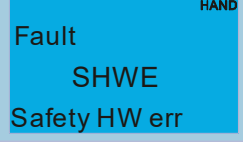
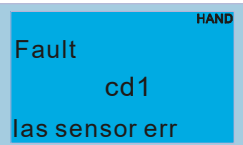
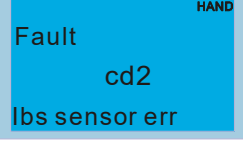
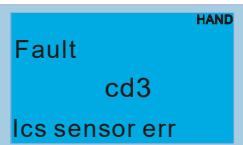
ID*	Fault Name	Fault Descriptions	Corrective Actions
24	 <p>Fault oH3 Motor over heat</p>	Motor overheating The AC motor drive detecting internal temperature exceeds the setting of Pr.06-30 (PTC level) or Pr.06-57 (PT100 level 2).	<ol style="list-style-type: none"> 1. Make sure that the motor is not obstructed. 2. Ensure that the ambient temperature falls within the specified temperature range. 3. Change to a higher power motor.
26	 <p>Fault ot1 Over torque 1</p>	These two fault codes will be displayed when output current exceeds the over-torque detection level (Pr.06-07 or Pr.06-10) and exceeds over-torque detection (Pr.06-08 or Pr.06-11) and it is set to 2 or 4 in Pr.06-06 or Pr.06-09.	<ol style="list-style-type: none"> 1. Check whether the motor is overloaded. 2. Check whether motor rated current setting (Pr.05-01) is suitable 3. Take the next higher power AC motor drive model.
27	 <p>Fault ot2 Over torque 2</p>		
28	 <p>Fault uC Under torque</p>	Low current detection	Check Pr.06-71, Pr.06-72, Pr.06-73.
30	 <p>Fault cF1 EEPROM write err</p>	Internal EEPROM can not be programmed.	<ol style="list-style-type: none"> 1. Press "RESET" key to the factory setting 2. Return to the factory.
31	 <p>Fault cF2 EEPROM read err</p>	Internal EEPROM can not be read.	<ol style="list-style-type: none"> 1. Press "RESET" key to the factory setting 2. Return to the factory.
32	 <p>Fault SHWE Safety HW err</p>	Safety hardware error	
33	 <p>Fault cd1 las sensor err</p>	U-phase error	Reboots the power. If fault code is still displayed on the keypad, please return to the factory
34	 <p>Fault cd2 lbs sensor err</p>	V-phase error	Reboots the power. If fault code is still displayed on the keypad, please return to the factory
35	 <p>Fault cd3 lcs sensor err</p>	W-phase error	Reboots the power. If fault code is still displayed on the keypad, please return to the factory

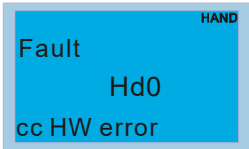
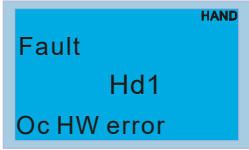
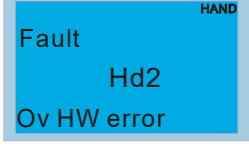
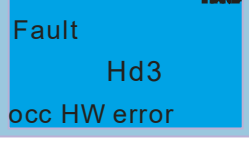
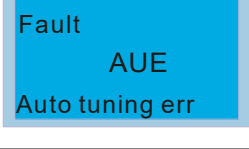
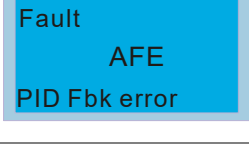
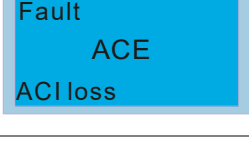
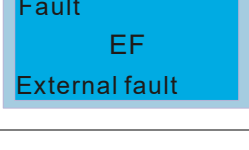
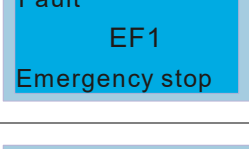
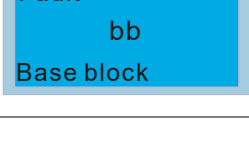
ID*	Fault Name	Fault Descriptions	Corrective Actions
36	 Fault Hd0 cc HW error	CC (current clamp)	Reboots the power. If fault code is still displayed on the keypad, please return to the factory
37	 Fault Hd1 Oc HW error	OC hardware error	Reboots the power. If fault code is still displayed on the keypad, please return to the factory
38	 Fault Hd2 Ov HW error	OV hardware error	Reboots the power. If fault code is still displayed on the keypad, please return to the factory
39	 Fault Hd3 occ HW error	Occ hardware error	Reboots the power. If fault code is still displayed on the keypad, please return to the factory
40	 Fault AUE Auto tuning err	Auto tuning error	<ol style="list-style-type: none"> 1. Check cabling between drive and motor 2. Check motor capacity and parameter setting 3. Try again.
41	 Fault AFE PID Fbk error	PID loss (ACI)	<ol style="list-style-type: none"> 1. Check the wiring of the PID feedback 2. Check the PID parameters settings
48	 Fault ACE ACI loss	ACI loss	<ol style="list-style-type: none"> 1. Check the ACI wiring 2. Check if the ACI signal is less than 4mA
49	 Fault EF External fault	External Fault	<ol style="list-style-type: none"> 1. Input EF (N.O.) on external terminal is closed to GND. Output U, V, W will be turned off. 2. Give RESET command after fault has been cleared.
50	 Fault EF1 Emergency stop	Emergency stop	<ol style="list-style-type: none"> 1. When the multi-function input terminals MI1 to MI6 are set to emergency stop, the AC motor drive stops output U, V, W and the motor coasts to stop. 2. Press RESET after fault has been cleared.
51	 Fault bb Base block	External Base Block	<ol style="list-style-type: none"> 1. When the external input terminal (B.B) is active, the AC motor drive output will be turned off. 2. Deactivate the external input terminal (B.B) to operate the AC motor drive again.

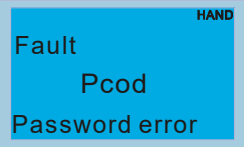
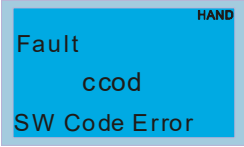
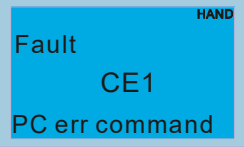
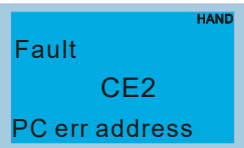
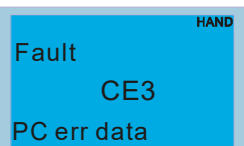
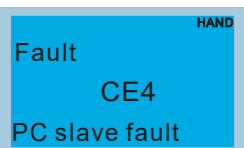
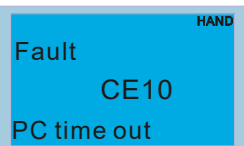
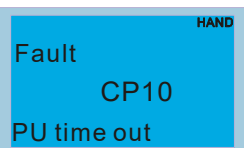
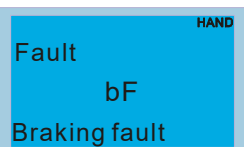
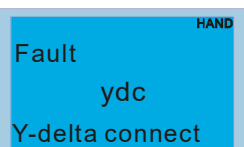
ID*	Fault Name	Fault Descriptions	Corrective Actions
52	 Fault pcod Password error	Password is locked.	Keypad will be locked. Turn the power ON after power OFF to re-enter the correct password. See Pr.00-07 and 00-08. Power off and restart the driver before entering the correct password.
53	 Fault ccod SW Code Error	Software version error	
54	 Fault CE1 PC err command	Illegal function code	Check if the function code is correct (function code must be 03, 06, 10, 63)
55	 Fault CE2 PC err address	Illegal data address (00H to 254H)	Check if the communication address is correct
56	 Fault CE3 PC err data	Illegal data value	Check if the data value exceeds max./min. value
57	 Fault CE4 PC slave fault	Data is written to read-only address	Check if the communication address is correct
58	 Fault CE10 PC time out	Modbus transmission time-out	
59	 Fault CP10 PU time out	Keypad transmission time-out	
60	 Fault bF Braking fault	Brake resistor fault	If the fault code is still displayed on the keypad after pressing "RESET" key, please return to the factory.
61	 Fault ydc Y-delta connect	Y-connection/ Δ -connection switch error	<ol style="list-style-type: none"> 1. Check the wiring of the Y-connection/Δ-connection 2. Check the parameters settings

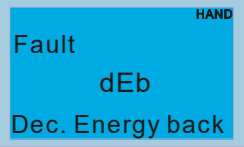
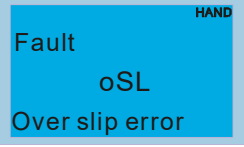
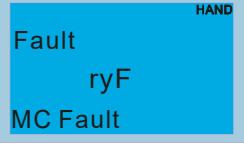
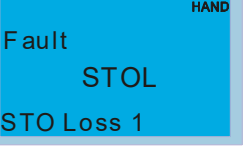
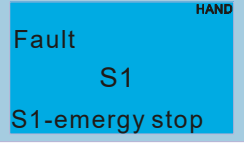
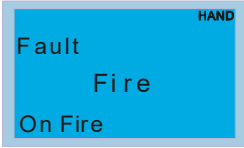
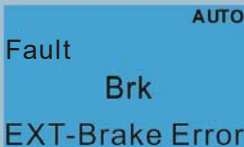
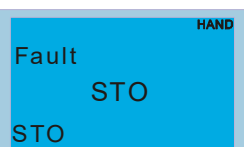
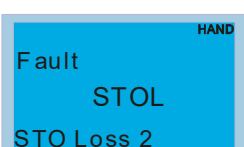
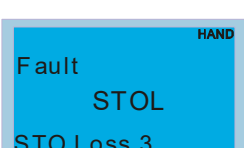
ID*	Fault Name	Fault Descriptions	Corrective Actions
62		When Pr.07-13 is not set to 0 and momentary power off or power cut, it will display dEb during accel./decel. stop.	<ol style="list-style-type: none"> 1. Set Pr.07-13 to 0 2. Check if input power is stable
63		It will be displayed when slip exceeds Pr.07-29 setting and time exceeds Pr.07-30 setting.	<ol style="list-style-type: none"> 1. Check if motor parameter is correct (please decrease the load if overload) 2. Check the settings of Pr.07-29 and Pr.07-30
64		Electric valve switch error when executing Soft Start. Do not disconnect RST when drive is still operating.	
72		STO1~SCM1 internal hardware detect error	
73		Emergency stop for external safety	
74		Fire mode	
75		External Brake Error	Verify M/I terminal signal
76		Safe Torque Off function active	
77		STO2~SCM2 internal hardware detect error	
78		STO1~SCM1 and STO2~SCM2 internal hardware detect error	

ID*	Fault Name	Fault Descriptions	Corrective Actions
79		U phase short circuit	
80		V phase short circuit	
81		W phase short circuit	
82		Output phase loss (Phase U)	
83		Output phase loss (Phase V)	
84		Output phase loss (Phase W)	
87		OL3 Derating error	
90		Internal PLC forced to stop Verify the setting of Pr.00-32	
99		CPU trap error	
101		CANopen guarding error	

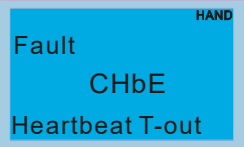
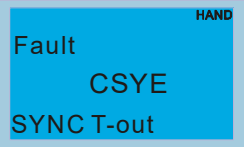
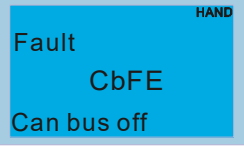
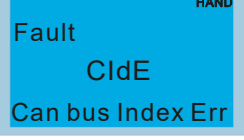
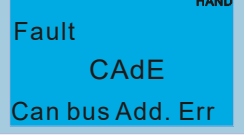
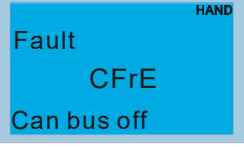
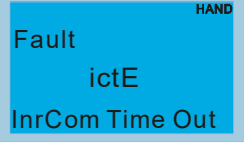
ID*	Fault Name	Fault Descriptions	Corrective Actions
102		CANopen heartbeat error	
103		CANopen synchronous error	
104		CANopen bus off error	
105		CANopen index error	
106		CANopen station address error	
107		CANopen memory error	
111		Internal communication time-out	

[This page intentionally left blank]

Chapter 15 CANopen Overview

15-1 CANopen Overview

15-2 Wiring for CANopen

15-3 CANopen Communication Interface Description

15-4 CANopen Supporting Index

15-5 CANopen Fault Code

15-6 CANopen LED Function

The built-in CANopen function is a kind of remote control. Master can control the AC motor drive by using CANopen protocol. CANopen is a CAN-based higher layer protocol. It provides standardized communication objects, including real-time data (Process Data Objects, PDO), configuration data (Service Data Objects, SDO), and special functions (Time Stamp, Sync message, and Emergency message). And it also has network management data, including Boot-up message, NMT message, and Error Control message. Refer to CiA website <http://www.can-cia.org/> for details. The content of this instruction sheet may be revised without prior notice. Please consult our distributors or download the most updated version at <http://www.delta.com.tw/industrialautomation>

Delta CANopen supporting functions:

- Support CAN2.0A Protocol;
- Support CANopen DS301 V4.02;
- Support DSP-402 V2.0.

Delta CANopen supporting services:

- PDO (Process Data Objects): PDO1~ PDO4
- SDO (Service Data Object):
 - Initiate SDO Download;
 - Initiate SDO Upload;
 - Abort SDO;
 - SDO message can be used to configure the slave node and access the Object Dictionary in every node.
- SOP (Special Object Protocol):
 - Support default COB-ID in Predefined Master/Slave Connection Set in DS301 V4.02;
 - Support SYNC service;
 - Support Emergency service.
- NMT (Network Management):
 - Support NMT module control;
 - Support NMT Error control;
 - Support Boot-up.

Delta CANopen not supporting service:

- Time Stamp service

15-1 CANopen Overview

CANopen Protocol

CANopen is a CAN-based higher layer protocol, and was designed for motion-oriented machine control networks, such as handling systems. Version 4.02 of CANopen (CiA DS301) is standardized as EN50325-4. The CANopen specifications cover application layer and communication profile (CiA DS301), as well as a framework for programmable devices (CiA 302), recommendations for cables and connectors (CiA 303-1) and SI units and prefix representations (CiA 303-2).

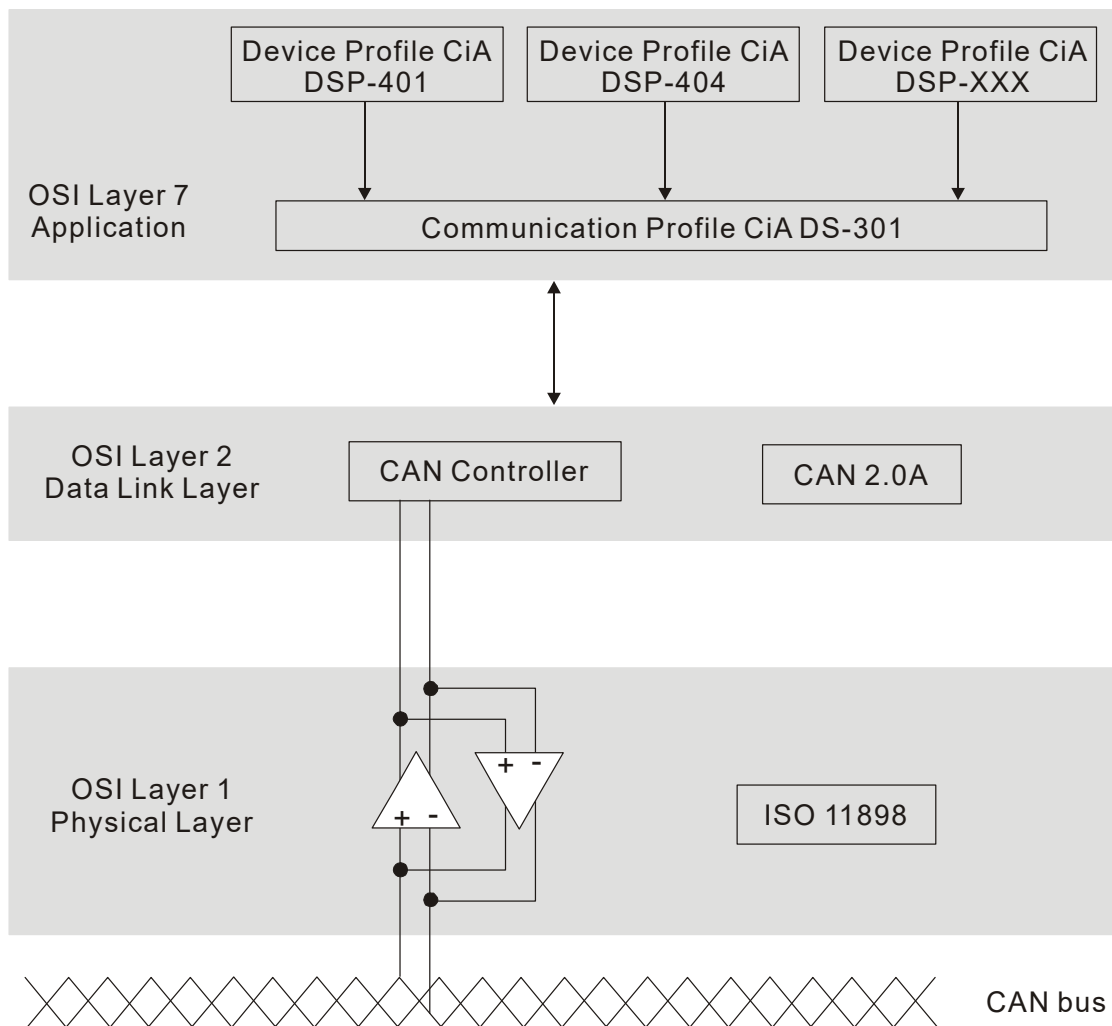

RJ-45 Pin Definition

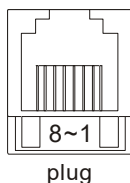

PIN	Signal	Description
1	CAN_H	CAN_H bus line (dominant high)
2	CAN_L	CAN_L bus line (dominant low)
3	CAN_GND	Ground / 0V /V-
6	CAN_GND	Ground / 0V /V-

CANopen Communication Protocol

It has services as follows:

- NMT (Network Management Object)
- SDO (Service Data Objects)
- PDO (Process Data Object)
- EMCY (Emergency Object)

NMT (Network Management Object)

The Network Management (NMT) follows a Master/Slave structure for executing NMT service. Only one NMT master is in a network, and other nodes are regarded as slaves. All CANopen nodes have a present NMT state, and NMT master can control the state of the slave nodes. The state diagram of a node is shown as follows:

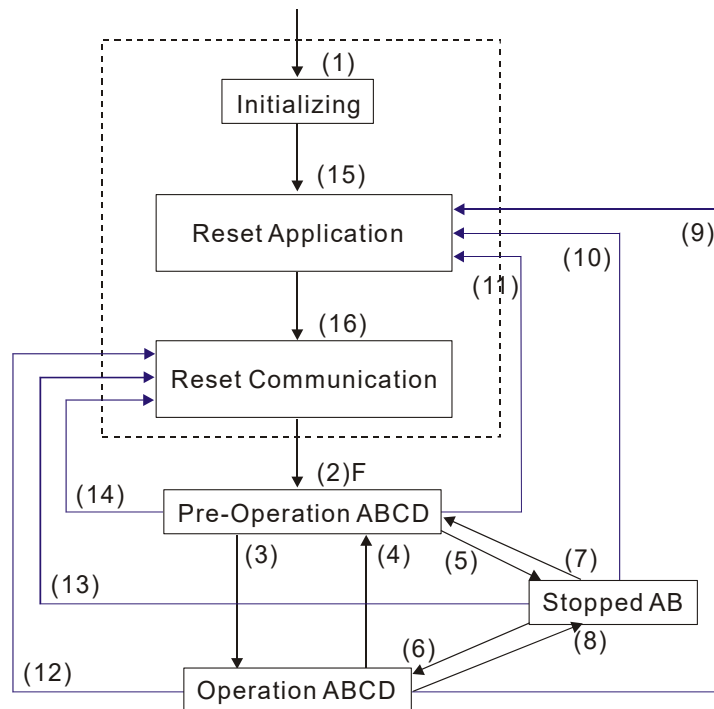

- (1) After power is applied, it is auto in initialization state
- (2) Enter pre-operational state automatically
- (3) (6) Start remote node
- (4) (7) Enter pre-operational state
- (5) (8) Stop remote node
- (9) (10) (11) Reset node
- (12) (13) (14) Reset communication
- (15) Enter reset application state automatically
- (16) Enter reset communication state automatically

- A: NMT
- B: Node Guard
- C: SDO
- D: Emergency
- E: PDO
- F: Boot-up

	Initializing	Pre-Operational	Operational	Stopped
PDO			○	
SDO		○	○	
SYNC		○	○	
Time Stamp		○	○	
EMCY		○	○	
Boot-up	○			
NMT		○	○	○

SDO (Service Data Objects)

SDO is used to access the Object Dictionary in every CANopen node by Client/Server model. One SDO has two COB-ID (request SDO and response SDO) to upload or download data between two nodes. No data limit for SDOs to transfer data. But it needs to transfer by segment when data exceeds 4 bytes with an end signal in the last segment.

The Object Dictionary (OD) is a group of objects in CANopen node. Every node has an OD in the system, and OD contains all parameters describing the device and its network behavior. The access path of OD is the index and sub-index, each object has a unique index in OD, and has sub-index if necessary. The request and response frame structure of SDO communication is shown as follows:

PDO (Process Data Object)

PDO communication can be described by the producer/consumer model. Each node of the network will listen to the messages of the transmission node and distinguish if the message has to be processed or not after receiving the message. PDO can be transmitted from one device to one another device or to many other devices. Every PDO has two PDO services: a TxPDO and a RxPDO. PDOs are transmitted in a non-confirmed mode.

PDO Transmission type is defined in the PDO communication parameter index (1400h for the 1st RxPDO or 1800h for the 1st TxPDO), and all transmission types are listed in the following table:

Type Number	PDO				
	Cyclic	Acyclic	Synchronous	Asynchronous	RTR only
0		○	○		
1-240	○		○		
241-251	Reserved				
252			○		○
253				○	○
254				○	
255				○	

Type number 1-240 indicates the number of SYNC message between two PDO transmissions.

Type number 252 indicates the data is updated (but not sent) immediately after receiving SYNC.

Type number 253 indicates the data is updated immediately after receiving RTR.

Type number 254: Delta CANopen doesn't support this transmission format.

Type number 255 indicates the data is asynchronous transmission.

All PDO transmission data must be mapped to index via Object Dictionary.

EMCY (Emergency Object)

When errors occurred inside the hardware, an emergency object will be triggered. An emergency object will only be sent when an error occurs. As long as there is nothing wrong with the hardware, there will be no emergency object to be served as a warning of an error message.

15-2 Wiring for CANopen

An external adapter card: EMC-COP01 is used for CANopen wiring to connect CANopen to CFP2000. The link is enabled by using RJ45 cable. The two farthest ends must be terminated with 120Ω terminating resistors.

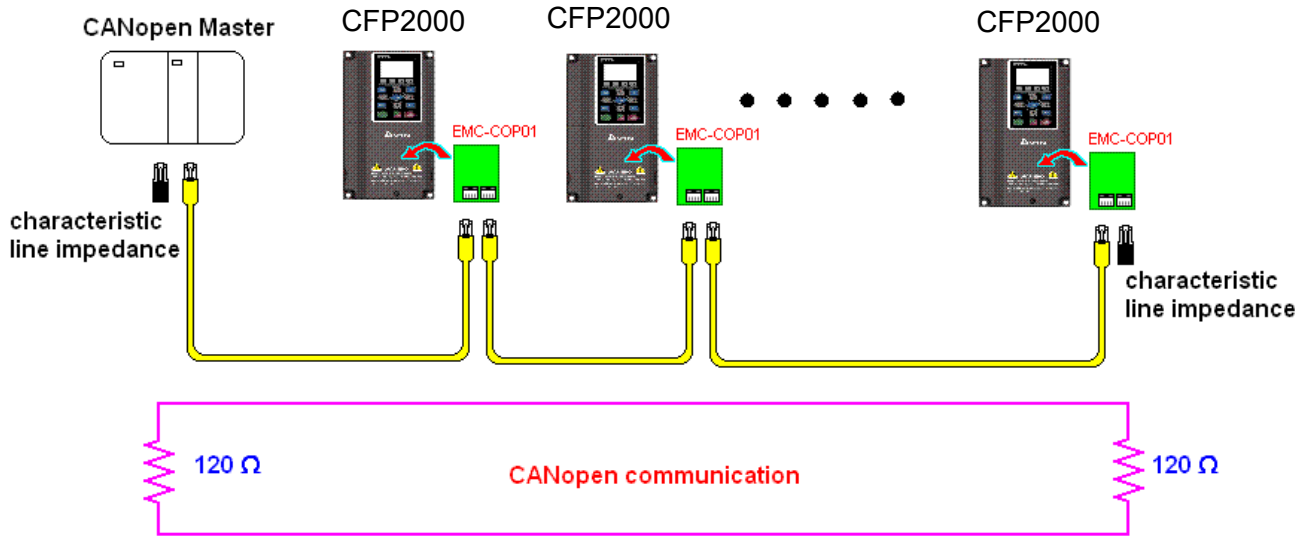

15-3 CANopen Communication Interface Descriptions

15-3-1 CANopen Control Mode Selection

There are two control modes for CANopen; Pr.09-40 set to 1 is the factory setting mode DS402 standard and Pr.09-40 set to 0 is Delta's standard setting mode.

There are also two control modes according to Delta's standard. One is the old control mode (Pr09-30=0), which can only control the motor drive under frequency control. Another one is a new standard (Pr09-30=1) control mode, that allows the motor drive to be controlled under all sort of mode. Currently, CFP2000 can only support speed mode.

The definition of relating control mode are:

CANopen Control Mode Selection	Control Mode	
	Speed	
	Index	Description
DS402 standard Pr09-40=1	6042-00	Target rotating speed (RPM)
	-----	-----
Delta Standard (Old definition) Pr09-40=0 Pr09-30=0	2020-02	Target rotating speed (Hz)
Delta Standard (New definition) Pr09-40=0, Pr09-30=1	2060-03	Target rotating speed (Hz)
	2060-04	Torque Limit (%)

CANopen Control Mode Selection	Operation Control	
	Index	Description
	DS402 standard Pr. 09-40=1	6040-00
-----		-----
Delta Standard (Old definition) P09-40=0, P09-30=0	2020-01	Operation Command
Delta Standard (New definition) Pr09-40=0, Pr09-30=1	2060-01	Operation Command
	-----	-----

CANopen Control Mode Selection	Other	
	Index	Description
	DS402 standard Pr. 09-40=1	605A-00
605C-00		Disable operation processing method
Delta Standard (Old definition) Pr09-40=1, Pr09-30=0	-----	-----
Delta Standard (New definition) Pr09-40=0, Pr09-30=1	-----	-----
	-----	-----

However, some index can be used regardless of DS402 or Delta's standard.

For example:

1. Index that is defined as RO attributes.
2. Index corresponds to parameters such as (2000 ~200B-XX)
3. Accelerating/Decelerating Index: 604F 6050
4. Control mode Index: 6060

15-3-2 DS402 Standard Control Mode

15-3-2-1 Related set up of ac motor drive (by following DS402 standard)

If you want to use DS402 standard to control the motor drive, please follow the steps below:

1. Wiring for hardware (refer to chapter 15-2 Wiring for CANopen)
2. Operation source setting: set Pr.00-21 to 3 for CANopen communication card control.
3. Frequency source setting: set Pr.00.20 to 6. (Choose source of frequency command from CANopen setting.)
4. Set DS402 as control mode: Pr09-40=1
5. CANopen station setting: set Pr.09-36 (Range of setting is 1~127. When Pr.09-36=0, CANopen slave function is disabled.) (Note: If error arise (CAde or CANopen memory error) as station setting is completed, press Pr.00-02=7 for reset.)
6. CANopen baud rate setting: set Pr.09-37 (CANBUS Baud Rate: 1Mbps(0), 500Kbps(1), 250Kbps(2), 125Kbps(3), 100Kbps(4) and 50Kbps(5))
7. Set multiple input functions to Quick Stop (it can also be enable or disable, default setting is disabled). If it is necessary to enable the function, set MI terminal to 53 in one of the following parameter: Pr.02.01~Pr.02.08 or Pr.02.26~Pr.02.31. (Note: This function is available in DS402 only.)

15-3-2-1 The status of the motor drive (by following DS402 standard)

According to the DS402 definition, the motor drive is divided into 3 blocks and 9 status as described below.

3 blocks

Power Disable: Without PWM output

Power Enable: With PWM output

Fault: One or more than one error has occurred.

9 status

Start: Power On

Not ready to switch on: The motor drive is initiating.

Switch On Disable: When the motor drive finishes the initiation, it will be at this mode.

Ready to switch on: Warming up before running.

Switch On: The motor derive has the PWM output now, but the reference commend is not effective.

Operate Enable: Able to control normally.

Quick Stop Active: When there is a Quick Stop request, you have to stop running the motor drive.

Fault Reaction Active: The motor drive detects conditions which might trigger error(s).

Fault: One or more than one error has occurred.

Therefore, when the motor drive is turned on and initiated, it will remain at Ready to Switch on

Index	Sub	Definition	Factory Setting	R/W	Size	Unit	PDO Map	Mode	note
605Ah	0	Quick stop option code	2	RW	S16		No		0 : disable drive function 1 :slow down on slow down ramp 2: slow down on quick stop ramp 5: slow down on slow down ramp and stay in QUICK STOP 6: slow down on quick stop ramp and stay in QUICK STOP 7: slow down on the current limit and stay in Quick stop

Besides, when the control section switches from Power Enable to Power Disable, use 605C to define parking method.

Index	Sub	Definition	Factory Setting	R/W	Size	Unit	PDO Map	Mode	note
605Ch	0	Disable operation option code	1	RW	S16		No		0: Disable drive function 1: Slow down with slow down ramp; disable of the drive function

15-3-2-3 Various mode control method (by following DS402 standard)

CFP2000 only supports speed control at present which is described as below:

Speed mode

1. Let Ac Motor Drive be at the speed control mode: Set Index6060 to 2.
2. Switch to Operation Enable mode: Set 6040=0xE, then set 6040 = 0xF.
3. To set target frequency: Set target frequency of 6042, since the operation unit of 6042 is rpm, there is a transformation:

$$n = f \times \frac{120}{p}$$

n: rotation speed (rpm) (rounds/minute)
 P: motor's pole number (Pole)
 f: rotation frequency (Hz)

For example:

Set 6042H = 1500 (rpm), if the motor drive's pole number is 4 (Pr05-04 or Pr05-16), then the motor drive's operation frequency is 1500(120/4)=50Hz.

Besides, the 6042 is defined as a signed operation. The plus or minus sign means to rotate clockwise or counter clockwise

4. To set acceleration and deceleration: Use 604F (Acceleration) and 6050 (Deceleration).
5. Trigger an ACK signal: In the speed control mode, the bit 6~4 of Index 6040 needs to be controlled. It is defined as below:

Speed mode (Index 6060=2)	Index 6040			SUM
	Bit 6	Bit 5	Bit 4	
	1	0	1	Locked at the current signal.
	1	1	1	Run to reach targeting signal.
	Other			Decelerate to 0Hz.

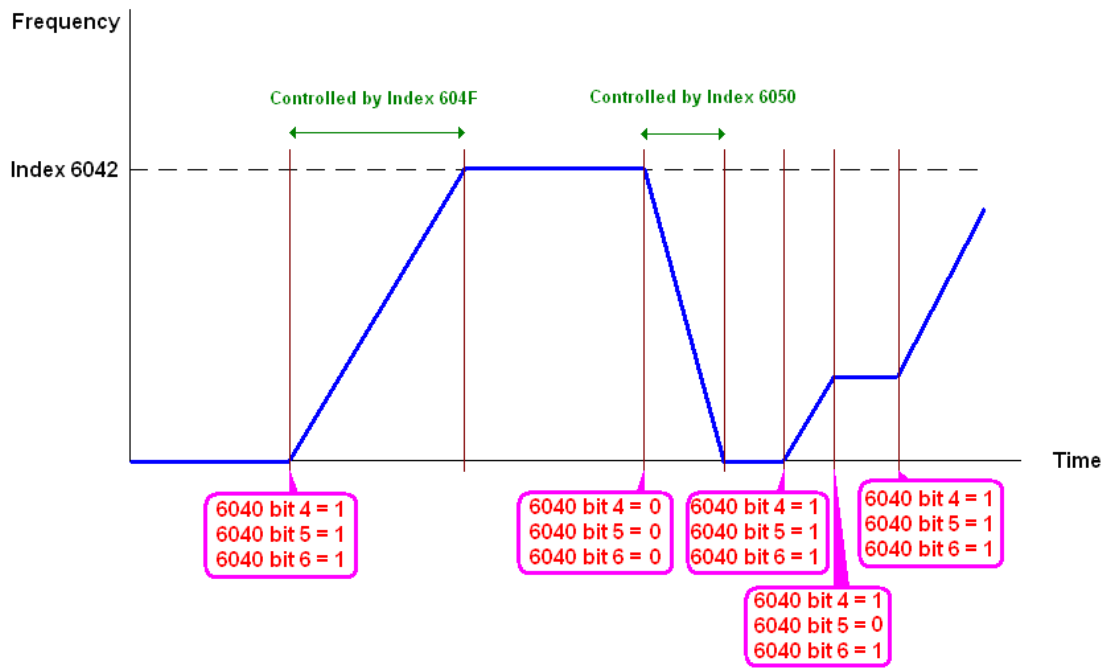

NOTE 01: To know the current rotation speed, read 6043. (unit: rpm)

NOTE 02: To know if the rotation speed can reach the targeting value; read bit 10 of 6041. (0: Not reached; 1: Reached)

15-3-3 By using Delta Standard (Old definition, only support speed mode)

15-3-3-1 Various mode control method (by following DS402 standard)

If you want to use DS402 standard to control the motor drive, please follow the steps below:

1. Wiring for hardware (Refer to chapter 15.2 Wiring for CANopen)
2. Operation source setting: set Pr.00-21 to 3 for CANopen communication card control.
3. Frequency source setting: set Pr.00.20 to 6. (Choose source of frequency command from CANopen setting.)
4. Set Delta Standard (Old definition, only support speed mode) as control mode: Pr. 09-40 = 0 and 09-30 = 0.
5. CANopen station setting: set Pr.09-36 (Range of setting is 1~127. When Pr.09-36=0, CANopen slave function is disabled.) (Note: If error occurs (CAde or CANopen memory error) as station setting is completed, press Pr.00-02=7 for reset.)
6. CANopen baud rate setting: set Pr.09-37 (CANBUS Baud Rate: 1Mbps(0), 500Kbps(1), 250Kbps(2), 125Kbps(3), 100Kbps(4) and 50Kbps(5))

15-3-3-2 By speed mode

1. Set the target frequency: Set 2020-02, the unit is Hz, with a number of 2 decimal places. For example 1000 is 10.00.
2. Operation control: Set 2020-01 = 0002H for Running, and set 2020-01 = 0001H for Stopping.

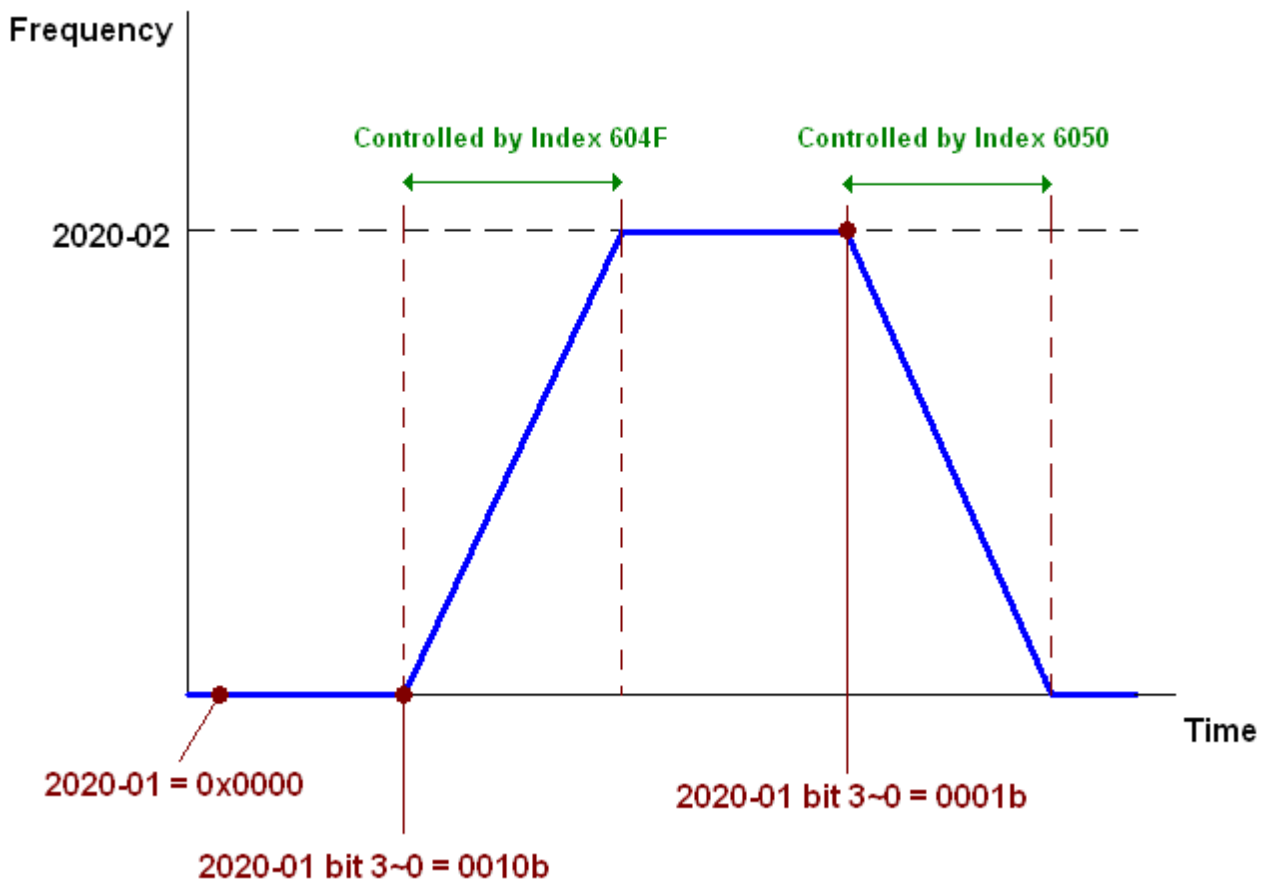

15-3-4 By using Delta Standard (New definition)

15-3-4-1 Related set up of AC motor drive (Delta New Standard)

If you want to use DS402 standard to control the motor drive, please follow the steps below:

1. Wiring for hardware (Refer to chapter 15-2 Wiring for CANopen)
2. Operation source setting: set Pr.00-21 to 3 for CANopen communication card control.
3. Frequency source setting: set Pr.00.20 to 6. (Choose source of frequency command from CANopen setting.)
4. Set Delta Standard (Old definition, only support speed mode) as control mode: Pr. 09-40 = 0 and 09-30 = 1
5. CANopen station setting: set Pr.09-36 (Range of setting is 1~127. When Pr.09-36=0, CANopen slave function is disabled.) (Note: If error occurred (CAde or CANopen memory error) as station setting is completed, press Pr.00-02=7 for reset.)
6. CANopen baud rate setting: set Pr.09.37 (CANBUS Baud Rate: 1Mbps(0), 500Kbps(1), 250Kbps(2), 125Kbps(3), 100Kbps(4) and 50Kbps(5))

15-3-4-2 Various mode control method (Delta New Standard)

Speed Mode

1. Let AC Motor Drive be at the speed control mode: Set Index6060 = 2.
2. Set the target frequency: set 2060-03, unit is Hz, with a number of 2 decimal places. For example, 1000 is 10.00Hz.
3. Operation control: set 2060-01 = 008H for Server on, and set 2060-01 = 0081H for Running.

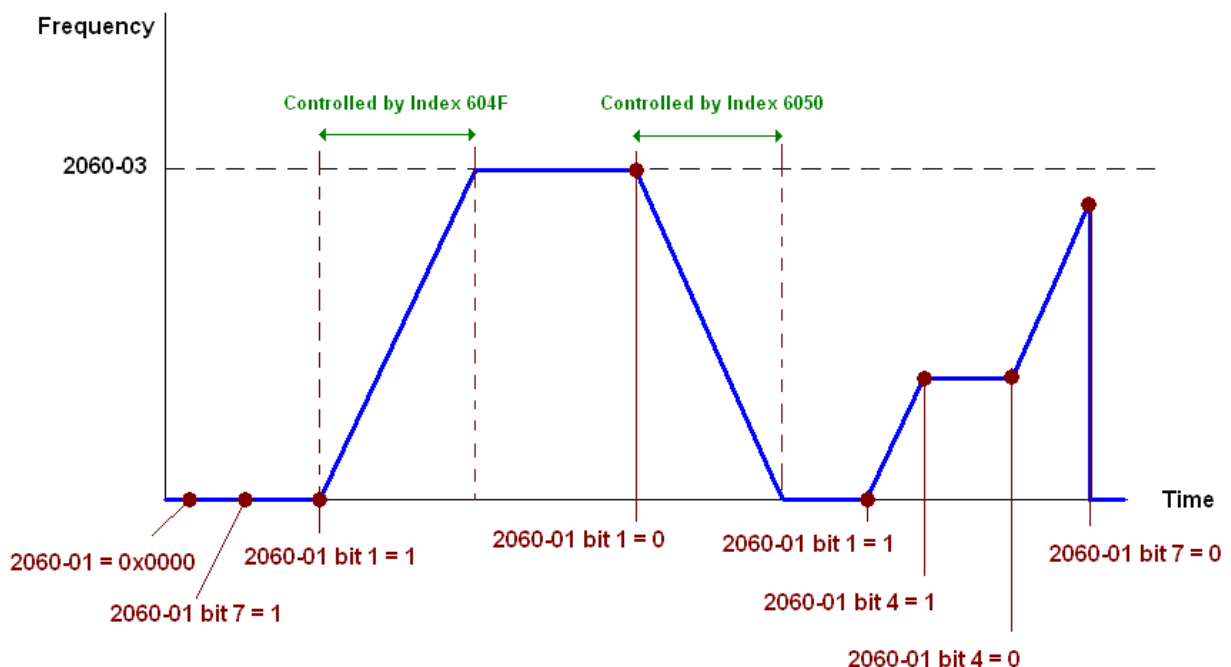

NOTE01: To know the current position, read 2061-05.

NOTE02: To know if reaching the target position, read bit 0 of 2061 (0: Not reached, 1: Reached).

15-3-5 DI/ DO/ AI/ AO are controlled via CANopen

To control the DO/AO of the motor drive through CANopen, follow the steps below:

1. To set the DO to be controlled, define this DO to be controlled by CANopen. For example, set Pr02-14=50 to control RY2.
2. To set the AO to be controlled, define this AO to be controlled by CANopen. For example, set Pr03-23=20 to control AFM2.
3. To control the mapping index of CANopen. If you want to control DO, then you will need to control Index2026-41. If you want to control AO, then you will need to control 2026-AX. If you want to set RY2 as ON, set the bit 1 of Index 2026-41 =1, then RY2 will output 1. If you want to control AFM2 output = 50.00%, then you will need to set Index 2026-A2 =5000, then AFM2 will output 50%.

Mapping table of CANopen DI/ DO/ AI/ AO:

DI:

Terminal	Related Parameters	R/W	Mapping Index
FWD	==	RO	2026-01 bit 0
REV	==	RO	2026-01 bit 1
MI 1	==	RO	2026-01 bit 2
MI 2	==	RO	2026-01 bit 3
MI 3	==	RO	2026-01 bit 4
MI 4	==	RO	2026-01 bit 5
MI 5	==	RO	2026-01 bit 6
MI 6	==	RO	2026-01 bit 7
MI 7	==	RO	2026-01 bit 8
MI 8	==	RO	2026-01 bit 9
MI 10	==	RO	2026-01 bit 10
MI 11	==	RO	2026-01 bit 11
MI 12	==	RO	2026-01 bit 12
MI 13	==	RO	2026-01 bit 13
MI 14	==	RO	2026-01 bit 14
MI 15	==	RO	2026-01 bit 15

DO :

Terminal	Related Parameters	R/W	Mapping Index
RY1	P2-13 = 50	RW	2026-41 bit 0
RY2	P2-14 = 50	RW	2026-41 bit 1
	P2-15 = 50	RW	2026-41 bit 2
MO1	P2-16 = 50	RW	2026-41 bit 3
MO2	P2-17 = 50	RW	2026-41 bit 4
MO3	P2-18 = 50	RW	2026-41 bit 5
MO4	P2-19 = 50	RW	2026-41 bit 6
MO5	P2-20 = 50	RW	2026-41 bit 7
MO6	P2-21 = 50	RW	2026-41 bit 8

Terminal	Related Parameters	R/W	Mapping Index
MO7	P2-22 = 50	RW	2026-41 bit 9
MO8	P2-23 = 50	RW	2026-41 bit 10

AI :

Terminal	Related Parameters	R/W	Mapping Index
AVI1	==	RO	Value of 2026-61
ACI	==	RO	Value of 2026-62
AVI2	==	RO	Value of 2026-63

AO :

Terminal	Related Parameters	R/W	Mapping Index
AFM1	P3-20 = 20	RW	Value of 2026-A1
AFM2	P3-23 = 20	RW	Value of 2026-A2

15-4 CANopen Supporting Index

CFP2000 Index:

Parameter index corresponds to each other as following:

Index	sub-Index
2000H + Group	member+1

For example:

Pr.10.15 (Encoder Slip Error Treatment)

Group	member
10(0 ^A H)	15(0FH)

Index = 2000H + 0AH = 200A

Sub Index = 0FH + 1H = 10H

CFP2000 Control Index:

Delta Standard Mode (Old definition)

Index	Sub	Definition	Factory Setting	R/W	Size	Note	
2020H	0	Number	3	R	U8		
	1	Control word	0	RW	U16	Bit 1~0	00B:disable 01B:stop 10B:disable 11B: JOG Enable
						Bit3~2	Reserved
						Bit5~4	00B:disable 01B: Direction forward 10B: Reverse 11B: Switch Direction
						Bit7~6	00B: 1 st step Accel. /Decel. 01B: 2 nd step Accel. /Decel. 10B: 3 rd step Accel. /Decel. 11B: 4 th step Accel. /Decel.
						Bit11~8	0000B: Master speed 0001B: 1 st step speed 0010B: 2 nd step speed 0011B: 3 rd step speed 0100B: 4 th step speed 0101B: 5 th step speed 0110B: 6 th step speed 0111B: 7 th step speed 1000B: 8 th step speed 1001B: 9 th step speed 1010B: 10 th step speed 1011B: 11 th step speed 1100B: 12 th step speed 1101B: 13 th step speed 1110B: 14 th step speed 1111B: 15 th step speed
						Bit12	1: Enable the function of Bit6-11
						Bit14~13	00B: no function 01B: Operation command by the digital keypad

Index	Sub	Definition	Factory Setting	R/W	Size	Note						
						Bit14~13	10B: Operation command by Pr. 00-21 setting 11B: Switch the source of operation command					
						Bit 15	Reserved					
						2	Freq. command (XXX.XXHz)	0	RW	U16		
	3	Other trigger	0	RW	U16	Bit0	1: E.F. ON					
						Bit1	1: Reset					
						Bit15~2	Reserved					
2021H	0	Number	DH	R	U8							
	1	Error code	0	R	U16	High byte: Warn code Low byte: Error code						
	2	AC motor drive status	0	R	U16	Bit 1~0	00B: stop 01B: decelerate to stop 10B: waiting for operation command 11B: in operation					
						Bit 2	1: JOG command					
						Bit 4~3	00B: forward running 01B: switch from reverse running to forward running 10B: switch from forward running to reverse running 11B: reverse running					
						Bit 7~5	Reserved					
						Bit 8	1: master frequency command controlled by communication interface					
						Bit 9	1: master frequency command controlled by analog signal input					
						Bit 10	1: operation command controlled by communication interface					
						Bit 15~11	Reserved					
						3	Freq. command (XXX.XXHz)	0	R	U16		
						4	Output freq. (XXX.XXHz)	0	R	U16		
	5	Output current (XX.XA)	0	R	U16							
	6	DC bus voltage (XXX.XV)	0	R	U16							
	7	Output voltage (XXX.XV)	0	R	U16							
	8	the current segment run by the multi-segment speed command	0	R	U16							
	9	Reserved	0	R	U16							
	A	Display counter value (c)	0	R	U16							
	B	Display output power angle (XX.X°)	0	R	U16							
	C	Display output torque (XXX.X%)	0	R	U16							
D	Display actual motor speed (rpm)	0	R	U16								
10	power output (X.XXXKWH)	0	R	U16								
2022H	0	Reserved	0	R	U16							
	1	Display output current	0	R	U16							
	2	Display counter value	0	R	U16							
	3	Display actual output frequency (XXX.XXHz)	0	R	U16							

Index	Sub	Definition	Factory Setting	R/W	Size	Note	
2022H	4	Display DC-BUS voltage (XXX.XV)	0	R	U16		
	5	Display output voltage (XXX.XV)	0	R	U16		
	6	Display output power angle (XX.X°)	0	R	U16		
	7	Display output power in kW	0	R	U16		
	8	Display actual motor speed (rpm)	0	R	U16		
	9	Display estimate output torque (XXX.X%)	0	R	U16		
	B	Display PID feedback value after enabling PID function in % (To 2 decimal places)	0	R	U16		
	C	Display signal of AVI1 analog input terminal, 0~10V corresponds to 0~100% (To 2 decimal places)	0	R	U16		
	D	Display signal of ACI analog input terminal, 4~20mA/0~10V corresponds to 0~100% (To 2 decimal places)	0	R	U16		
	E	Display signal of AVI2 analog input terminal, -10V~10V corresponds to -100~100% (To 2 decimal places)	0	R	U16		
	F	Display the IGBT temperature of drive power module in °C	0	R	U16		
	10	Display the temperature of capacitance in °C	0	R	U16		
	11	The status of digital input (ON/OFF), refer to Pr.02-12	0	R	U16		
	12	The status of digital output (ON/OFF), refer to Pr.02-18	0	R	U16		
	13	Display the multi-step speed that is executing	0	R	U16		
	14	The corresponding CPU pin status of digital input	0	R	U16		
	15	The corresponding CPU pin status of digital output	0	R	U16		
	19	Position command tracing error	0	R	U16		
	1A	Display times of counter overload (0.00~100.00%)	0	R	U16		
	1B	Display GFF in %	0	R	U16		
	1C	Display DCbus voltage ripples (Unit: VDC)	0	R	U16		
	1D	Display PLC register D1043 data	0	R	U16		
	1E	Display Pole of Permanent Magnet Motor	0	R	U16		
1F	User page displays the value in physical measure	0	R	U16			
20	Output Value of Pr.00-05	0	R	U16			
21	Number of motor turns when drive operates	0	R	U16			
22	Operation position of motor	0	R	U16			
23	Fan speed of the drive	0	R	U16			

Index	Sub	Definition	Factory Setting	R/W	Size	Note
	24	Control mode of the drive 0: speed mode	0	R	U16	
	25	Carrier frequency of the drive	0	R	U16	

CANopen Remote IO mapping

Index	Sub	R/W	Definition
2026H	01h	R	Each bit corresponds to the different input terminals
	02h	R	Each bit corresponds to the different input terminals
	03h~40h	R	Reserved
	41h	RW	Each bit corresponds to the different output terminals
	42h~60h	R	Reserved
	61h	R	AVI1 (%)
	62h	R	ACI (%)
	63h	R	AVI2 (%)
	64h~A0h	R	Reserved
	A1h	RW	AFM1 (%)
	A2h	RW	AFM2 (%)

Delta Standard Mode (New definition)

Index	sub	R/W	Size	Descriptions			Speed Mode
				bit	Definition	Priority	
2060h	00h	R	U8				
	01h	RW	U16	0	Ack	4	0:fcmd =0 1:fcmd = Fset(Fpid)
				1	Dir	4	0: FWD run command 1: REV run command
				2			
				3	Halt		0: drive run till target speed is attained 1: drive stop by deceleration setting
				4	Hold		0: drive run till target speed is attained 1: frequency stop at current frequency
				5	JOG		0:JOG OFF Pulse 1:JOG RUN
				6	QStop		Quick Stop
				7	Power		0:Power OFF 1:Power ON
				14~8			
				15			Pulse 1: Fault code cleared
	02h	RW	U16				
	03h	RW	U16				Speed command (unsigned decimal)
	04h	RW	U16				
	05h	RW	S32				
06h	RW						
07h	RW	U16					
08h	RW	U16					
2061h	01h	R	U16	0	Arrive		Frequency attained
				1	Dir		0: Motor FWD run 1: Motor REV run
				2	Warn		Warning

Index	sub	R/W	Size	Descriptions			Speed Mode
				bit	Definition	Priority	
				3	Error		Error detected
				4			
				5	JOG		JOG
				6	QStop		Quick stop
				7	Power On		Switch ON
				15~8			
	02h	R					
	03h	R	U16				Actual output frequency
	04h	R					
	05h	R	S32				Actual position (absolute)
	06h	R					
	07h	R	S16				Actual torque

DS402 Standard

Index	Sub	Definition	Factory Setting	R/W	Size	Unit	PDO Map	Mode	Note
6007h	0	Abort connection option code	2	RW	S16		Yes		0: No action 2: Disable Voltage 3: quick stop
603Fh	0	Error code	0	R0	U16		Yes		
6040h	0	Control word	0	RW	U16		Yes		
6041h	0	Status word	0	R0	U16		Yes		
6042h	0	vl target velocity	0	RW	S16	rpm	Yes	vl	
6043h	0	vl velocity demand	0	RO	S16	rpm	Yes	vl	
6044h	0	vl control effort	0	RO	S16	rpm	Yes	vl	
604Fh	0	vl ramp function time	10000	RW	U32	1ms	Yes	vl	Unit must be: 100ms, and check if the setting is set to 0.
6050h	0	vl slow down time	10000	RW	U32	1ms	Yes	vl	
6051h	0	vl quick stop time	1000	RW	U32	1ms	Yes	vl	
605Ah	0	Quick stop option code	2	RW	S16		No		0 : disable drive function 1 :slow down on slow down ramp 2: slow down on quick stop ramp 5 slow down on slow down ramp and stay in QUICK STOP 6 slow down on quick stop ramp and stay in QUICK STOP
605Ch	0	Disable operation option code	1	RW	S16		No		0: Disable drive function 1: Slow down with slow down ramp; disable of the drive function
6060h	0	Mode of operation	2	RW	S8		Yes		1: Profile Position Mode 2: Velocity Mode 4: Torque Profile Mode 6: Homing Mode
6061h	0	Mode of operation display	2	RO	S8		Yes		Same as above
6071h	0	tq Target torque	0	RW	S16	0.1%	Yes	tq	Valid unit: 1%
6072h	0	tq Max torque	150	RW	U16	0.1%	No	tq	Valid unit: 1%
6075h	0	tq Motor rated current	0	RO	U32	mA	No	tq	
6077h	0	tq torque actual value	0	RO	S16	0.1%	Yes	tq	

Index	Sub	Definition	Factory Setting	R/W	Size	Unit	PDO Map	Mode	Note
6078h	0	tq current actual value	0	RO	S16	0.1%	Yes	tq	
6079h	0	tq DC link circuit voltage	0	RO	U32	mV	Yes	tq	

15-5 CANopen Fault Code

①	Fault	①	Display error signal
②	ocA	②	Abbreviate error code
③	Oc at accel	③	Display error description











*Follow the settings of Pr.06-17~Pr.06-22

ID No.	Display	Fault code	Description	CANopen fault register (bit0~7)	CANopen fault code
1	Fault ocA Oc at accel	0001H	Over-current during acceleration	1	2213 H
2	Fault ocd Oc at decel	0002H	Over-current during deceleration	1	2213 H
3	Fault ocn Oc at normal SPD	0003H	Over-current during steady status operation	1	2214H
4	Fault GFF Ground fault	0004H	Ground fault. When (one of) the output terminal(s) is grounded, short circuit current is more than 50% of AC motor drive rated current. NOTE: The short circuit protection is provided for AC motor drive protection, not for protection of the user.	1	2240H
5	Fault occ Short Circuit	0005H	Short-circuit is detected between upper bridge and lower bridge of the IGBT module.	1	2250H
6	Fault ocS Oc at stop	0006H	Over-current at stop. Hardware failure in current detection	1	2314H
7	Fault ovA Ov at accel	0007H	Over-current during acceleration. Hardware failure in current detection	2	3210H

ID No.	Display	Fault code	Description	CANopen fault register (bit0~7)	CANopen fault code
8	Fault ovd Ov at decel	0008H	Over-current during deceleration. Hardware failure in current detection.	2	3210H
9	Fault ovn Ov at normal SPD	0009H	Over-current during steady speed. Hardware failure in current detection.	2	3210H
10	Fault ovS Ov at stop	000AH	Over-voltage at stop. Hardware failure in current detection	2	3210H
11	Fault LvA Lv at accel	000BH	DC BUS voltage is less than Pr.06.00 during acceleration.	2	3220H
12	Fault Lvd Lv at decel	000CH	DC BUS voltage is less than Pr.06.00 during deceleration.	2	3220H
13	Fault Lvn Lv at normal SPD	000DH	DC BUS voltage is less than Pr.06.00 in constant speed.	2	3220H
14	Fault LvS Lv at stop	000EH	DC BUS voltage is less than Pr.06-00 at stop	2	3220H
15	Fault OrP Phase Lacked	000FH	Phase Loss Protection	2	3130H
16	Fault oH1 IGBT over heat	0010H	IGBT overheat IGBT temperature exceeds protection level. 1~15HP: 90°C 20~100HP: 100°C	3	4310H
17	Fault oH2 Hear Sink oH	0011H	Heat sink overheat Heat sink temperature exceeds 90°C	3	4310H
18	Fault tH1o Thermo 1 open	0012H	Temperature detection circuit error (IGBT) IGBT NTC	3	FF00H

ID No.	Display	Fault code	Description	CANopen fault register (bit0~7)	CANopen fault code
19	Fault tH2o Thermo 2 open	0013H	Temperature detection circuit error (capacity module) CAP NTC	3	FF01H
21	Fault oL Inverter oL	0015H	Overload. The AC motor drive detects excessive drive output current. NOTE: The AC motor drive can withstand up to 150% of the rated current for a maximum of 60 seconds.	1	2310H
22	Fault EoL1 Thermal relay 1	0016H	Electronics thermal relay 1 protection	1	2310H
23	Fault EoL2 Thermal relay 2	0017H	Electronics thermal relay 2 protection	1	2310H
24	Fault oH3 Motor over heat	0018H	Motor PTC overheat	3	FF20H
26	Fault ot1 Over torque 1	001AH	These two fault codes will be displayed when output current exceeds the over-torque detection level (Pr.06-07 or Pr.06-10) and exceeds over-torque detection (Pr.06-08 or Pr.06-11) and it is set 2 or 4 in Pr.06-06 or Pr.06-09.	3	8311H
27	Fault ot2 Over torque 2	001BH		3	8311H
28	Fault uC Under torque 1	001CH	Low current	1	8321H
30	Fault cF1 EEPROM write Err	001EH	Internal EEPROM cannot be programmed.	5	5530H
31	Fault cF2 EEPROM read Err	001FH	Internal EEPROM cannot be read.	5	5530H
33	Fault cd1 las sensor Err	0021H	U-phase error	1	FF04H

ID No.	Display	Fault code	Description	CANopen fault register (bit0~7)	CANopen fault code
34	Fault cd2 lbs sensor Err	0022H	V-phase error	1	FF05H
35	Fault cd3 lcs sensor Err	0023H	W-phase error	1	FF06H
36	Fault Hd0 cc HW Error	0024H	cc (current clamp) hardware error	5	FF07H
37	Fault Hd1 oc HW Error	0025H	oc hardware error	5	FF08H
38	Fault Hd2 ov HW Error	0026H	ov hardware error	5	FF09H
39	Fault Hd3 GFF HW Error	0027H	GFF hardware error	5	FF0AH
40	Fault AUE Auto tuning Err	0028H	Auto tuning error	1	FF21H
41	Fault AFE PID Fbk Error	0029H	PID loss (ACI)	7	FF22H
48	Fault ACE ACI loss	0030H	ACI loss	1	FF25H
49	Fault EF External Fault	0031H	External Fault When input EF (N.O.) on external terminal is closed to GND, AC motor drive stops output U, V, and W.	5	9000H

ID No.	Display	Fault code	Description	CANopen fault register (bit0~7)	CANopen fault code
50	 Fault EF1 Emergency stop	0032H	Emergency stop When the multi-function input terminals MI1 to MI6 are set to emergency stop, the AC motor drive stops output U, V, W and the motor coasts to stop.	5	9000H
51	 Fault bb Base block	0033H	External Base Block When the external input terminals MI1 to MI16 are set as bb and active, the AC motor drive output will be turned off	5	9000H
52	 Fault Pcod Password Error	0034H	Password will be locked if three fault passwords are entered	5	FF26H
53	 Fault ccod SW code Error	0035H	Software error	5	6100H
54	 Fault cE1 Modbus CMD err	0036H	Illegal function code	4	7500H
55	 Fault cE2 Modbus ADDR err	0037H	Illegal data address (00H to 254H)	4	7500H
56	 Fault cE3 Modbus DATA err	0038H	Illegal data value	4	7500H
57	 Fault cE4 Modbus slave FLT	0039H	Data is written to read-only address	4	7500H
58	 Fault cE10 Modbus time out	003AH	Modbus transmission timeout.	5	7500H
59	 Fault cP10 Keypad time out	003BH	Keypad transmission timeout.	4	7500H

ID No.	Display	Fault code	Description	CANopen fault register (bit0~7)	CANopen fault code
60	Fault bF Braking fault	003CH	Brake resistor fault	4	7110H
61	Fault ydc Y-delta connect	003DH	Motor Y-Δ switch error	2	3330H
62	Fault dEb Dec. Energy back	003EH	Energy regeneration when decelerating	2	FF27H
63	Fault oSL Over slip Error	003FH	Over slip error. Slip exceeds Pr.05.26 limit and slip duration exceeds Pr.05.27 setting.	7	FF28H
64	Fault ryF MC Fault	0040H	Electric valve switch error when executing Soft Start.	5	7110H
72	Fault STL1 STO Loss 1	0048H	STO1~SCM1 internal hardware detect error	5	5441H
73	Fault S1 S1-Emergency stop	0049H	external safety emergency stop	5	FF2AH
74	Fault Fire On Fire	004AH	Fire mode	7	FF2FH
76	Fault STo STO	004CH	Safe torque off function active	5	7110H
77	Fault STL2 STO Loss 2	004DH	STO2~SCM2 internal hardware detect error.	5	5440H
78	Fault STL3 STO Loss 3	004EH	STO1~SCM1 & STO2~SCM2 internal hardware detect error.	5	5442H

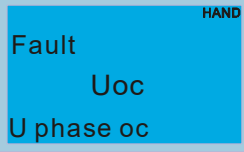
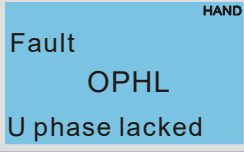
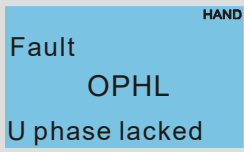
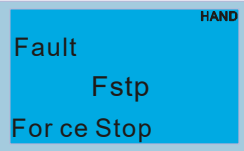
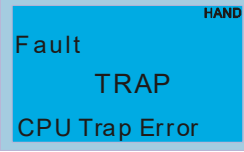
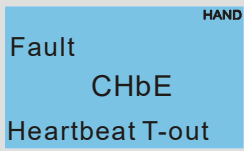
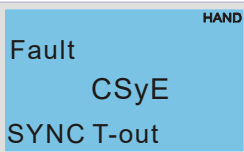
ID No.	Display	Fault code	Description	CANopen fault register (bit0~7)	CANopen fault code
79	 <p>Fault Uoc U phase oc</p>	004FH	U-phase short circuit	1	FF2BH
80	 <p>Fault Voc V phase oc</p>	0050H	V-phase short circuit	1	FF2CH
81	 <p>Fault Woc W phase oc</p>	0051H	W-phase short circuit	1	FF2DH
82	 <p>Fault OPHL U phase lacked</p>	0052H	U phase output phase loss	2	2331H
83	 <p>Fault OPHL U phase lacked</p>	0053H	V phase output phase loss	2	2332H
84	 <p>Fault OPHL U phase lacked</p>	0054H	W phase output phase loss	2	2333H
90	 <p>Fault Fstp Force Stop</p>	005AH	Internal PLC forced to stop Verify the setting of Pr.00-32	7	FF2EH
99	 <p>Fault TRAP CPU Trap Error</p>	0063H	CPU trap error	7	6000H
101	 <p>Fault CGdE Guarding T-out</p>	0065H	Guarding time-out 1	4	8130H
102	 <p>Fault CHbE Heartbeat T-out</p>	0066H	Heartbeat time-out	4	8130H
103	 <p>Fault CSyE SYNC T-out</p>	0067H	CAN synchrony error	4	8700H

ID No.	Display	Fault code	Description	CANopen fault register (bit0~7)	CANopen fault code
104	<div style="border: 1px solid black; padding: 2px;"> HAND Fault CbFE CAN/S bus off </div>	0068H	CAN bus off	4	8140H
105	<div style="border: 1px solid black; padding: 2px;"> HAND Fault CIdE CAN/S ldx exceed </div>	0069H	Can index exceed	4	8110H
106	<div style="border: 1px solid black; padding: 2px;"> HAND Fault CAde CAN/S add. set </div>	006AH	CAN address error	4	8100H
107	<div style="border: 1px solid black; padding: 2px;"> HAND Fault CFdE CAN/S FRAM fail </div>	006BH	CAN frame fail	4	8100H
111	<div style="border: 1px solid black; padding: 2px;"> HAND Fault ictE InrCom Time Out </div>	006FH	Internal communication error	4	7500H

15-6 CANopen LED Function

There are two CANopen flash signs: RUN and ERR.

RUN LED:

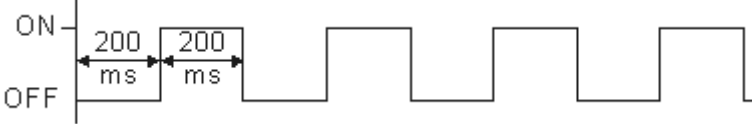
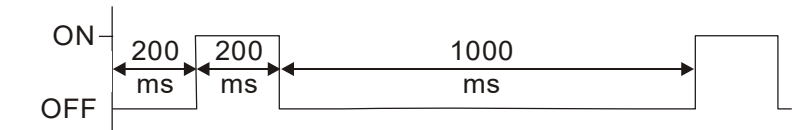
LED status	Condition	CANopen State
OFF		Initial
Blinking		Pre-Operation
Single flash		Stopped
ON		Operation

ERR LED:

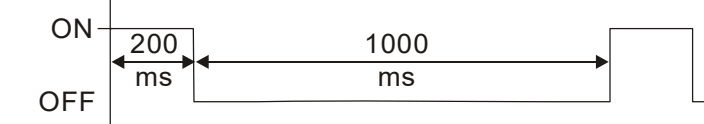
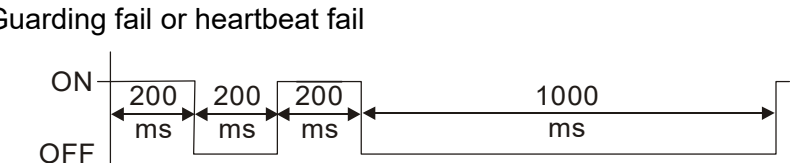
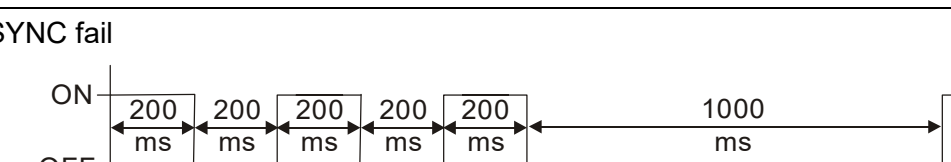
LED status	Condition/ State
OFF	No Error
Single flash	One Message fail 
Double flash	Guarding fail or heartbeat fail 
Triple flash	SYNC fail 
ON	Bus off

Chapter 16 PLC Function Applications

- 16-1 PLC Summary
- 16-2 Notes before PLC use
- 16-3 Turn on
- 16-4 Basic principles of PLC ladder diagrams
- 16-5 Various PLC device functions
- 16-6 Introduction to the Command Window
- 16-7 Error display and handling
- 16-8 CANopen Master control applications
- 16-9 Explanation of various PLC mode controls
- 16-10 Internal communications main node control
- 16-11 Modbus remote IO control applications (use MODRW)
- 16-12 Calendar

16-1 PLC Summary

16-1-1 Introduction

The commands provided by the CFP2000's built-in PLC functions, including the ladder diagram editing tool WPLSoft, as well as the usage of basic commands and applications commands, chiefly retain the operating methods of Delta's PLC DVP series.

16-1-2 WPLSoft ladder diagram editing tool

WPLSoft is Delta's program editing software for the DVP and CFP2000 programmable controllers in the Windows operating system environment. Apart from general PLC program design general Windows editing functions (such as cut, paste, copy, multiple windows, etc.), WPLSoft also provides many Chinese/English annotation editing and other convenience functions (such as registry editing, settings, file reading, saving, and contact graphic monitoring and settings, etc.).

The following basic requirements that need to install WPLSoft editing software:

Item	System requirements
Operating system	Windows 95/98/2000/NT/ME/XP
CPU	At least Pentium 90
Memory	At least 16MB (32MB and above is recommended)
Hard drive	Hard drive capacity: at least 100MB free space One optical drive (for use in installing this software)
Display	Resolution: 640×480, at least 16 colors; it is recommended that the screen area be set at 800×600 pixels
Mouse	Ordinary mouse or Windows-compatible device
Printer	Printer with a Windows driver program
RS-485 port	Must have at least an RS-485 port to link to the PLC

16-2 Notes before PLC use

1. The PLC has a preset communications format of 7, N, 2, 9600, with node 2; the PLC node can be changed in parameter 09-35, but this address may not be the same as the converter's address setting of 09-00.
2. The CFP2000 provides 2 communications serial ports that can be used to download PLC programs (see figure below). Channel 1 has a fixed communications format of 19200, 8, N, 2 RTU.

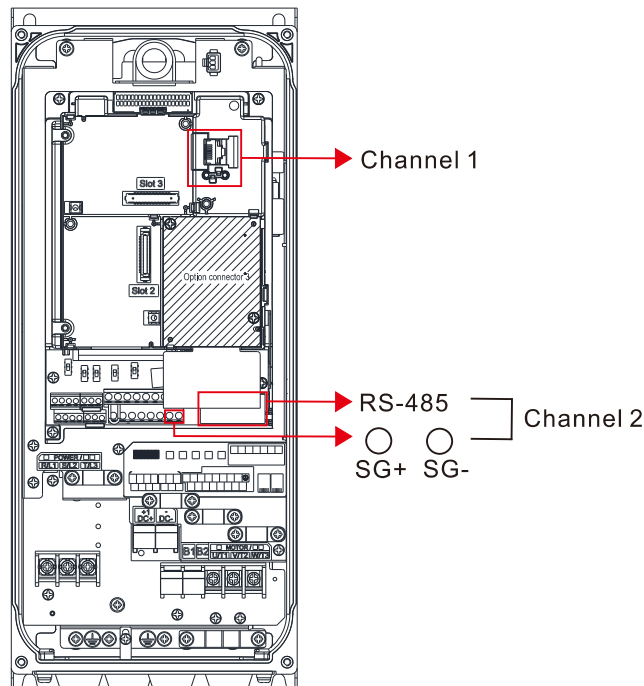

3. The client can simultaneously access data from the converter and internal PLC, which is performed through identification of the node. For instance, if the converter node is 1 and the internal PLC node is 2, then the client command will be
 01 (node) 03 (read) 0400 (address) 0001 (1 data item), indicating that it must read the data in converter parameter 04-00
 02 (node) 03 (read) 0400 (address) 0001 (1 data item), indicating that it must read the data in internal PLC X0
4. The PLC program will be disabled when uploading/downloading programs.
5. Please note when using WPR commands to write in parameters, values may be modified up to a maximum of 10^9 times, otherwise a memory write error will occur. The calculation of modifications is based on whether the entered value has been changed. If the entered value is left unchanged, the modifications will not increase afterwards. But if the entered value is different from before, the number of modifications will increase by one. Those parameters in the table below are exceptions, please proceed to the next page for details:

	CFP2000
Pr00-10, Control mode	-----
Pr00-11, Velocity mode;	Yes
Pr00-12, P2P mode	-----
Pr00-13, Torque mode	-----
Pr01-12~P01-19, 1 st ~ 4 th Acc/Dec time;	Yes
Pr02-12, MULTI-Input ACT;	Yes
Pr02-18, MULTI-Output ACT	Yes
Pr04-50~Pr04-59 PLC buffer 1~10;	Yes
Pr08-04, Up Limit for I	Yes
Pr08-05, PID Out-Limit %;	Yes
Pr10-17, Electrical Gear A	-----

6. When parameter 00-04 is set as 28, the displayed value will be the value of PLC register D1043 (see figure below):

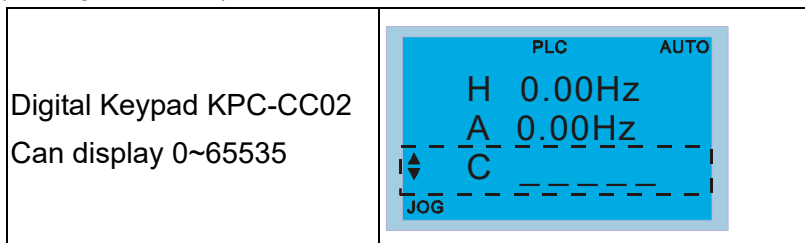

7. In the PLC Run and PLC Stop mode, the content 9 and 10 of parameter 00-02 cannot be set nor be reset to the default value.
8. The PLC can be reset to the default value when parameter 00-02 is set as 6.
9. The corresponding MI function will be disabled when the PLC writes to input contact X.
10. When the PLC controls converter operation, control commands will be entirely controlled by the PLC and will not be affected by the setting of parameter 00-21.
11. When the PLC controls converter frequency commands (FREQ commands), frequency commands will be entirely controlled by the PLC, and will not be affected by the setting of parameter 00-20 or the Hand ON/OFF configuration.
12. When the PLC controls converter frequency (TORQ commands), torque commands will be entirely controlled by the PLC, and will not be affected by the setting of parameter 11-33 or the Hand ON/OFF configuration.
13. When the PLC controls converter frequency (POS commands), position commands will be entirely controlled by the PLC, and will not be affected by the setting of parameter 11-40 or the Hand ON/OFF configuration.
14. When the PLC controls converter operation, if the keypad Stop setting is valid, this will trigger an FStP error and cause stoppage.

16-3 Turn on

16-3-1 Connect to PC

Start operation of PLC functions in accordance with the following four steps

1. After pressing the Menu key and selecting 4: PLC on the KPC-CC02 digital keypad, press the Enter key (see figure below).

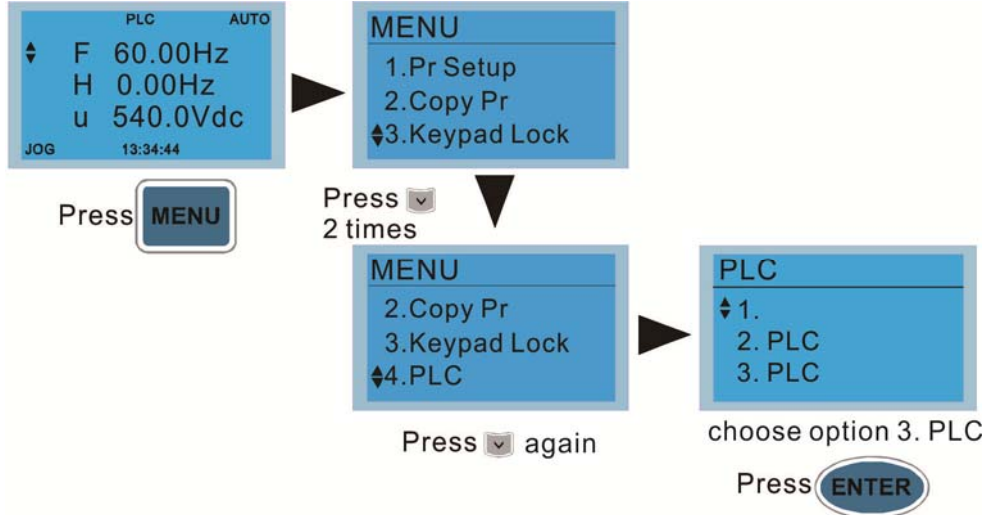

2. Wiring: Connect the driver's RJ-45 communications interface to a PC via the RS485

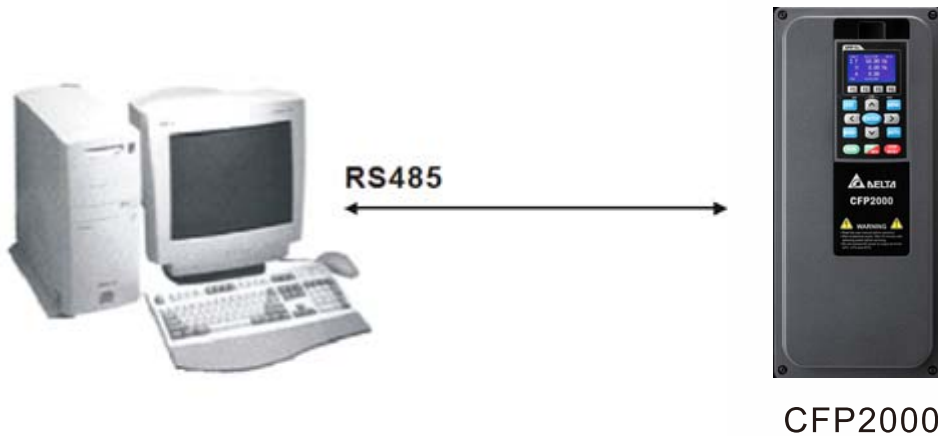

3. PLC function usage

PLC

◆ 1.Disable

2.PLC Run

3.PLC Stop

- PLC functions are as shown in the figure on the left; select item 2 and implement PLC functions.

1: No function (Disable)

2: Enable PLC (PLC Run)

3: Stop PLC functions (PLC Stop)

- When the external multifunctional input terminals (MI1 to MI8) are in PLC Mode select bit0 (51) or PLC Mode select bit1 (52), and the terminal contact is closed or open, it will compulsorily switch to the PLC mode, and keypad switching will be ineffective.

Corresponding actions are as follows:

PLC mode	PLC Mode select bit1(52)	PLC Mode select bit0 (51)
Using KPC-CC02		
Disable	OFF	OFF
PLC Run	OFF	ON

PLC mode	PLC Mode select bit1(52)	PLC Mode select bit0 (51)
Using KPC-CC02		
PLC Stop	ON	OFF
Maintain previous state	ON	ON

 **NOTE**

- When input/output terminals (FWD REV MI1 to MI8 MI10 to 15, Relay1, Relay2 RY10 to RY15, MO1 to MO2 MO10 to MO11,) are included in the PLC program, these input/output terminals will only be used by the PLC. As an example, when the PLC program controls Y0 during PLC operation (PLC1 or PLC2), the corresponding output terminal relay (RA/RB/RC) will operate in accordance with the program. At this time, the multifunctional input/output terminal setting will be ineffective. Because these terminal functions are already being used by the PLC, the DI DO AO in use by the PLC can be determined by looking at parameter 02-52, 02-53, and 03-30.
- When the PLC's procedures use special register D1040, the corresponding AO contact AFM1 will be occupied, and AFM2 corresponding to special register D1045 will have the same situation.
- Parameter 03-30 monitors the state of action of the PLC function analog output terminal; Bit0 corresponds to the AFM1 action state, and Bit1 corresponds to the AFM2 action state.

16-3-2 I/O device explanation

Input devices:

Serial No.	X0	X1	X2	X3	X4	X5	X6	X7	X10	X11	X12	X13	X14	X15	X16	X17
1	FWD	REV	MI1	MI2	MI3	MI4	MI5	MI6	MI7	MI8						
2											MI10	MI11	MI12	MI13	MI14	MI15
3											MI10	MI11	MI12	MI13		

1: Control I/O

2: Expansion card: EMC-D611A (D1022=4)

3: Expansion card: EMC-D42A (D1022=5)

Output devices:

Serial No.	Y0	Y1	Y2	Y3	Y4	Y5	Y6	Y7	Y10	Y11	Y12	Y13	Y14	Y15	Y16	Y17
1	RY1	RY2		MO1	MO2											
2						MO10	MO11									
3						RY10	RY11	RY12	RY13	RY14	RY15					

1: Control I/O

2: Expansion card: EMC-D42A (D1022=5)

3: Expansion card: EMC-R6AA (D1022=6)

16-3-3 Installation WPLSoft

See Delta's website for WPLSoft editing software:

<http://www.delta.com.tw/industrialautomation/download>.

16-3-4 Program writing

After completing installation, the WPLSoft program will be installed in the designated subfolder "C:\Program Files\Delta Industrial Automation\WPLSoft x.xx." The editing software can now be run by clicking on the WPL icon using the mouse.



The WPL editing window will appear after 3 seconds (see figure below). When running WPLSoft for the first time, before "New file" has been used, only the "File (F)," "Communications (C)," "View (V)," "Options (O)," and "Help (H)" columns will appear on the function toolbar.

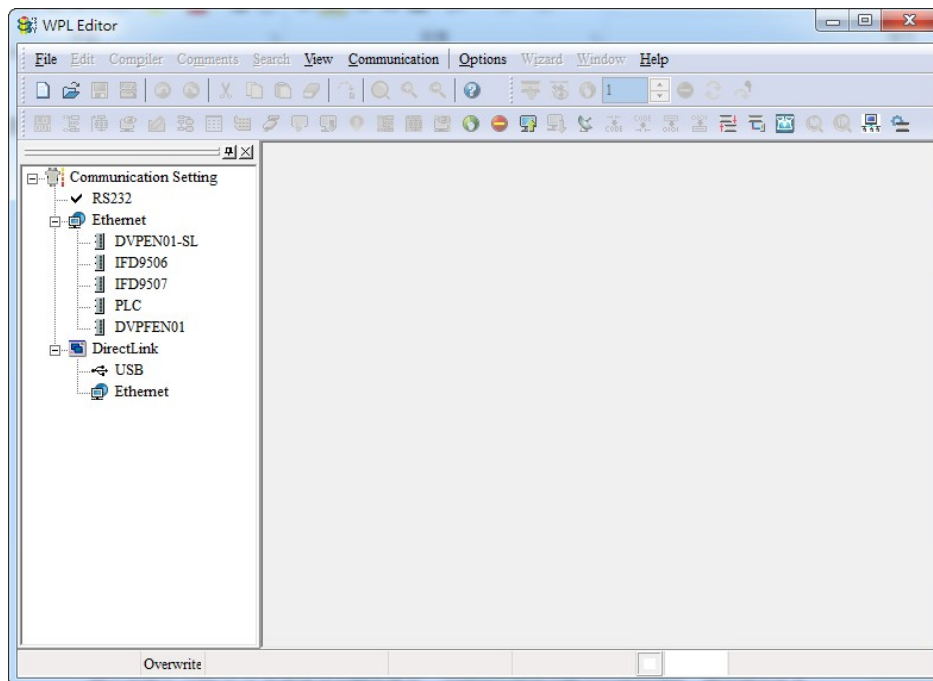

After running WPLSoft for the second time, the last file edited will open and be displayed in the editing window. The following figure provides an explanation of the WPLSoft editing software window:

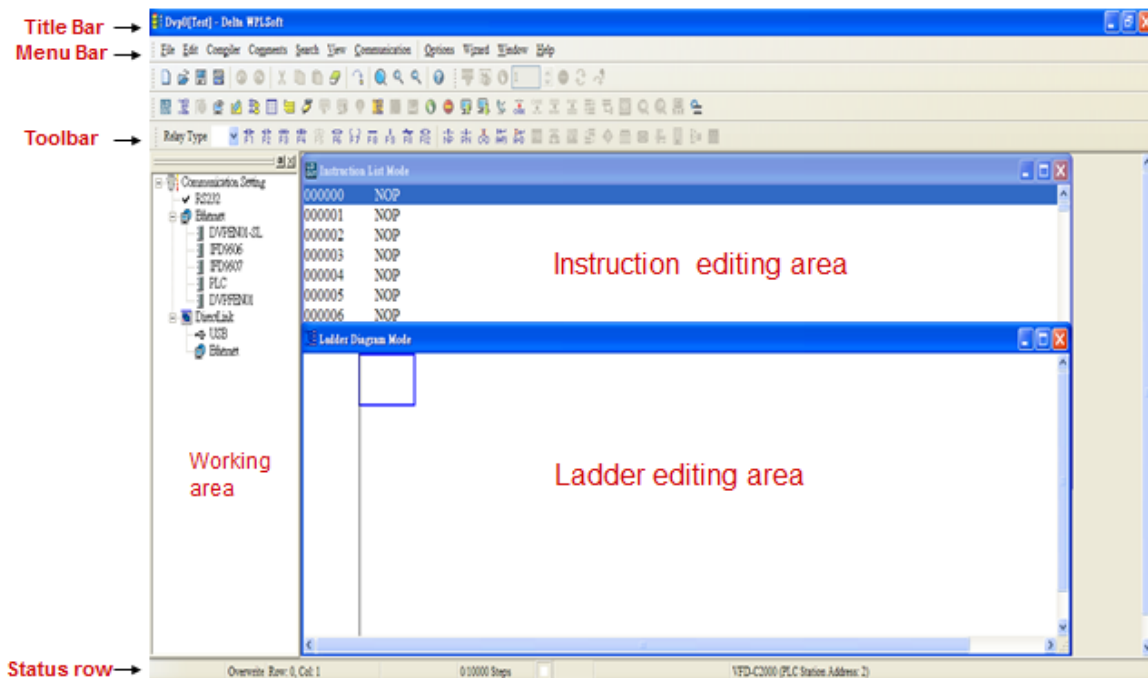

Click on the  icon on the toolbar in the upper left part of the screen: opens new file (Ctrl+N)

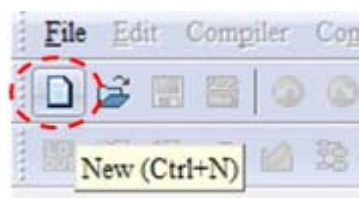

You can also use "File (F)"=> New file (N) (Ctrl+N)

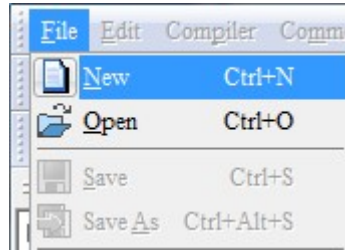

The "Device settings" window will appear after clicking. You can now enter the project title and filename, and select the device and communication settings to be used.

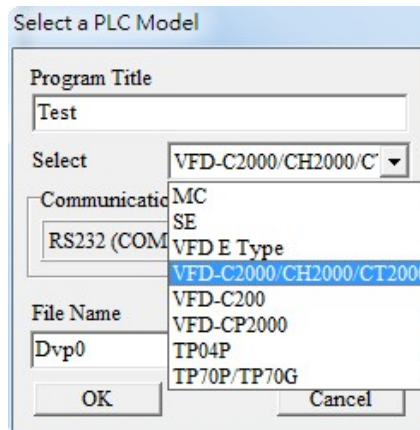

Communications settings: Perform settings in accordance with the desired communications method.

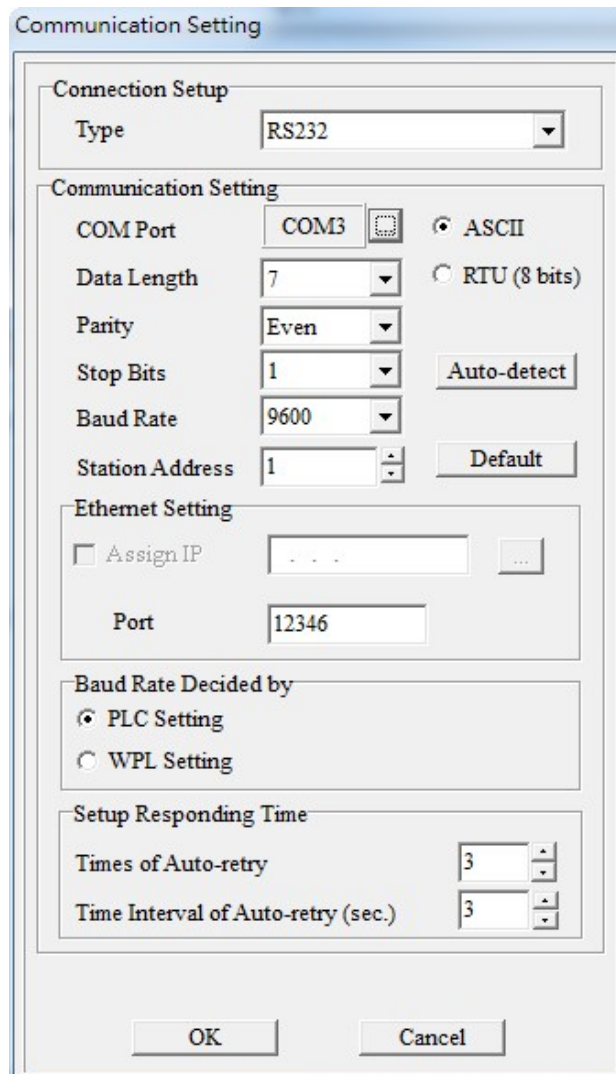

Press Confirm after completing settings and begin program editing. There are two program-editing methods; you can choose whether to perform editing in the command mode or the ladder diagram mode.

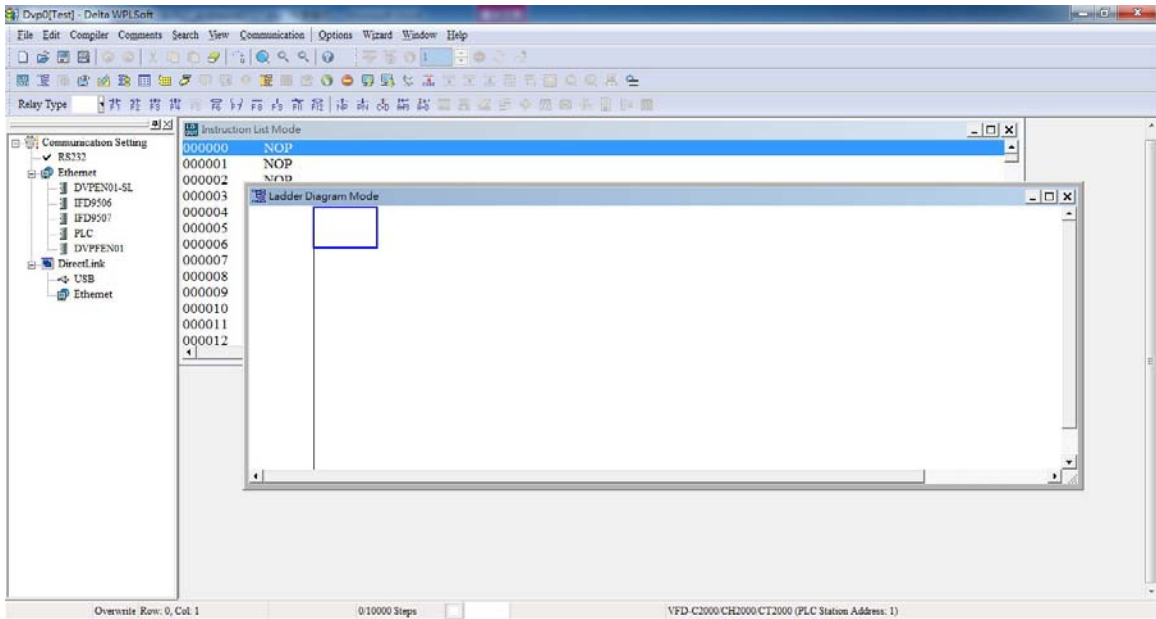

In ladder diagram mode, you can perform program editing using the buttons on the function icon row

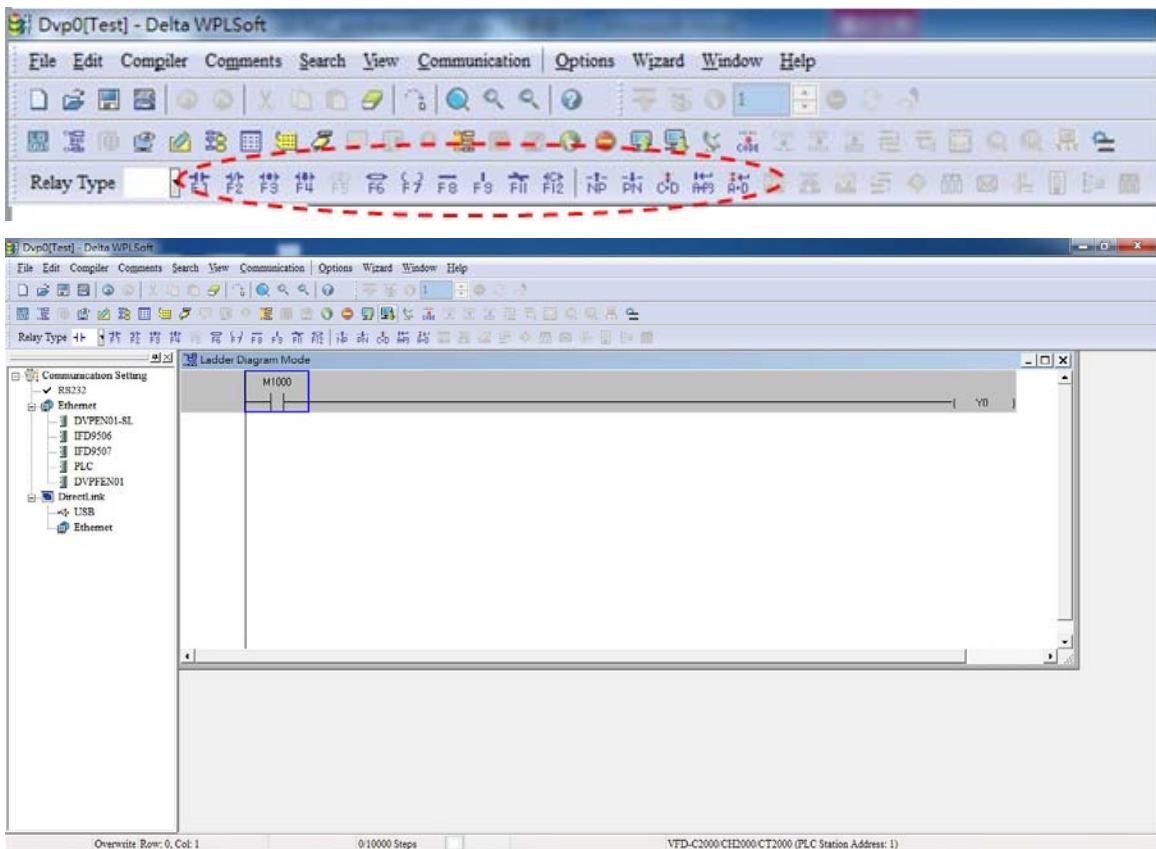

Basic Operation

Example: Input the ladder diagram in the following figure

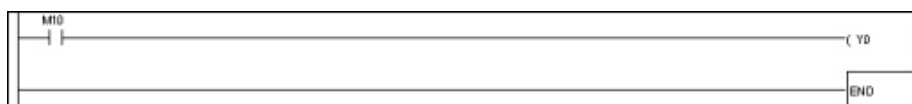

Mouse operation and keyboard function key (F1 to F12) operation

1. The following screen will appear after a new file has been established:

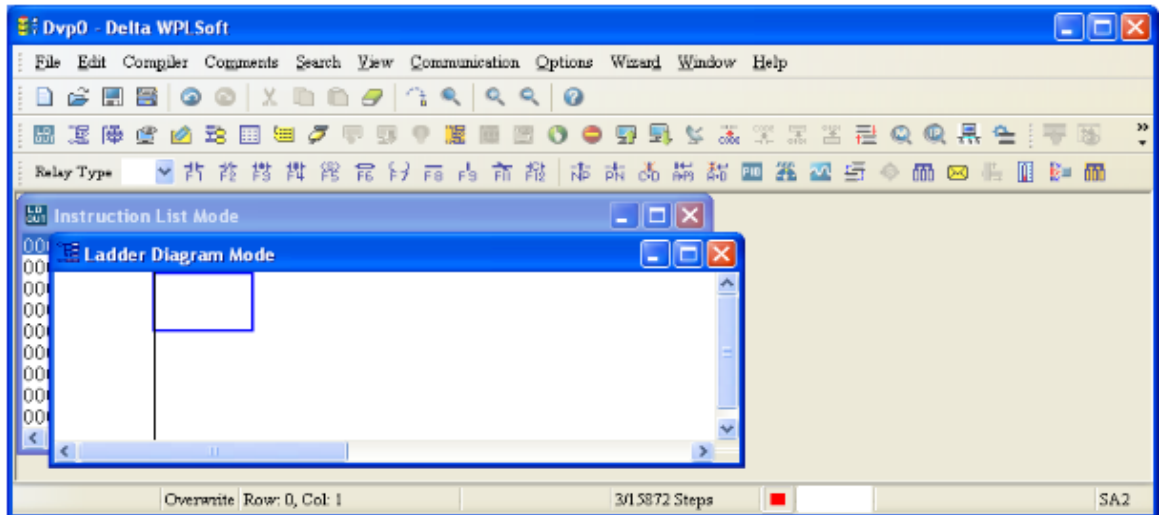

2. Use the mouse to click on the always-open switch icon  or press the function key F1:

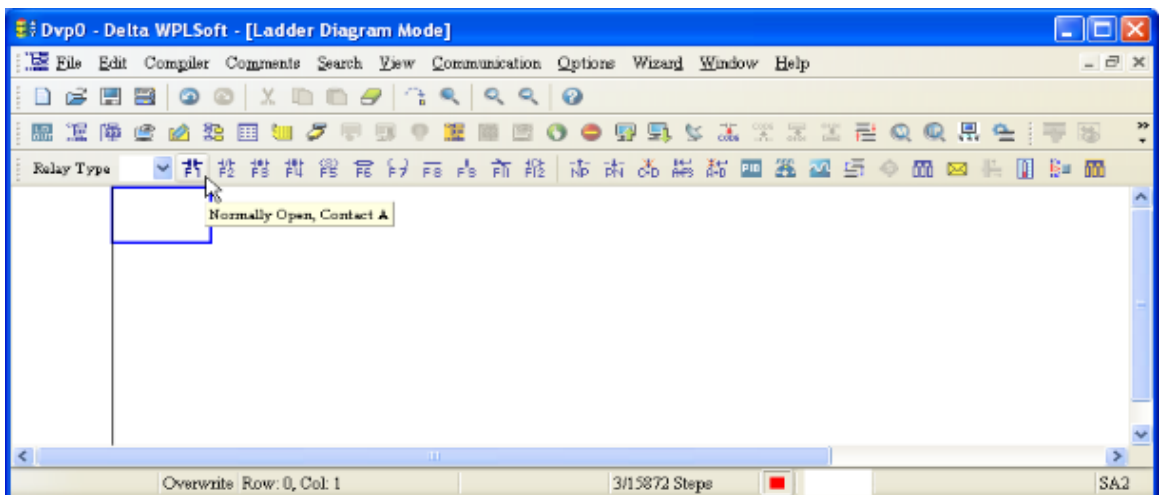

3. After the name of the input device and the comment dialog box have appeared, the device name (such as "M"), device number (such as "10"), and input comments (such as "auxiliary contact") can be selected; press the Confirm button when finished.

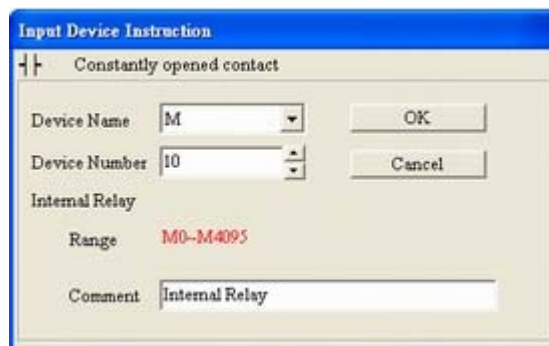

- Click on the output coil icon  or press function key F7. After the name of the input device and the comment dialog box have appeared, the device name (such as "Y"), device number (such as "0"), and input comments (such as "output coil") can be selected; press the Confirm button when finished.

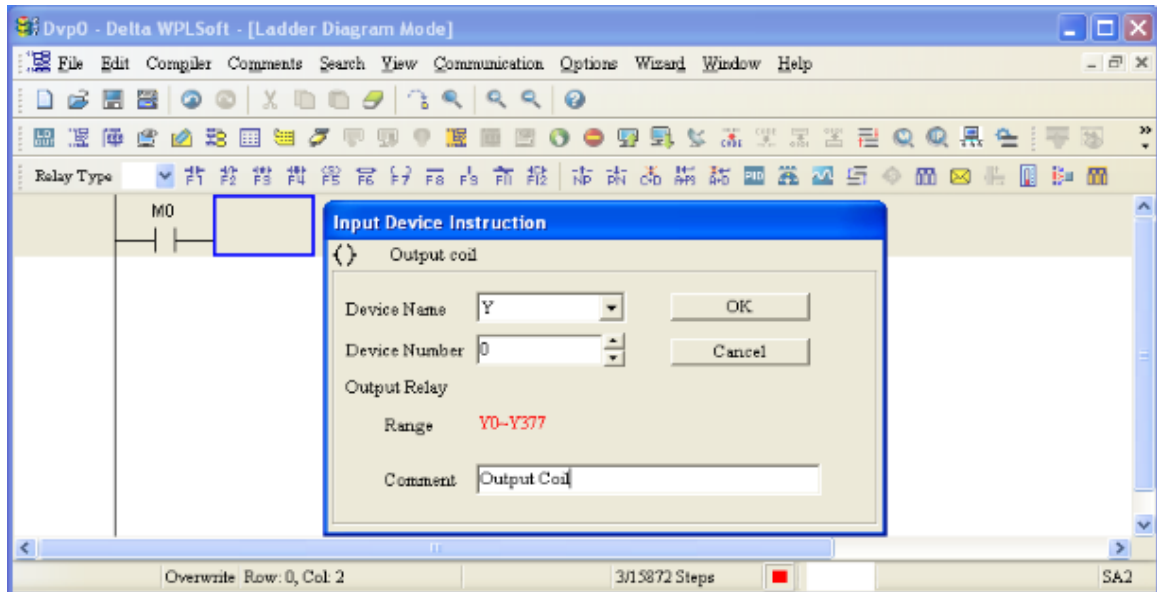

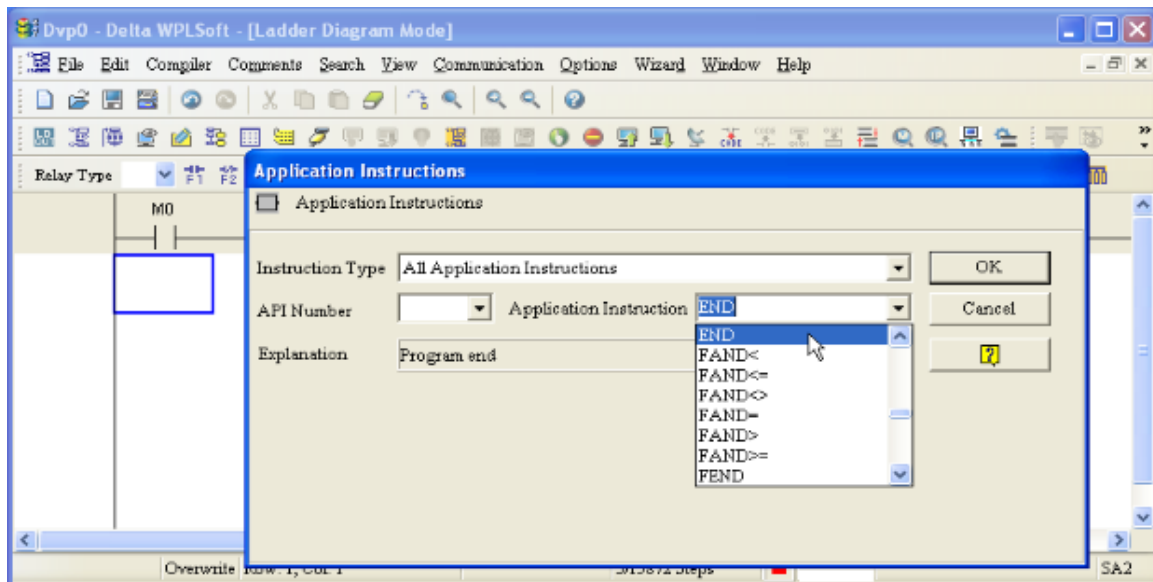

- Click on application command icon  or press function key F6. Click on "All application commands" in the function classification field, and click on the End command in the application command pull-down menu, or use the keyboard to key in "End" in that field, and press the confirm button.

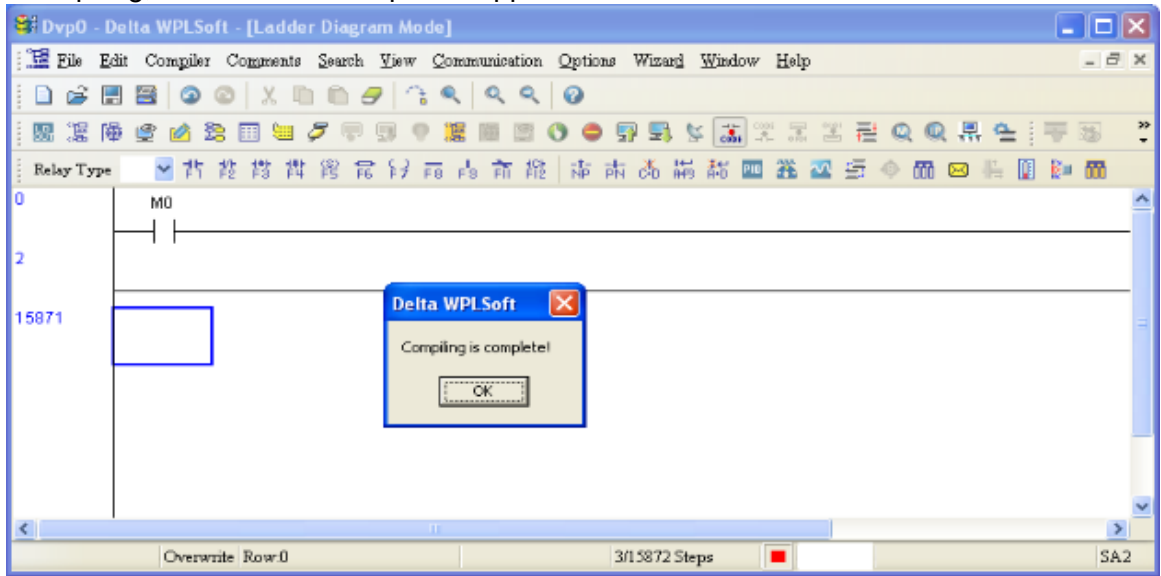

- Click on the  icon, which will compile the edited ladder diagram as a command program. After compiling, the number of steps will appear on the left side of the busbar.



16-3-5 Program download

After inputting a program using WPLSoft, select compile . After completing compilation, select the  to download a program. WPLSoft will perform program download with the online PLC in the communications format specified in communications settings.

16-3-6 Program monitoring

While confirming that the PLC is in the Run mode, after downloading a program, click on  in the communications menu and select start ladder diagram control (see figure below)

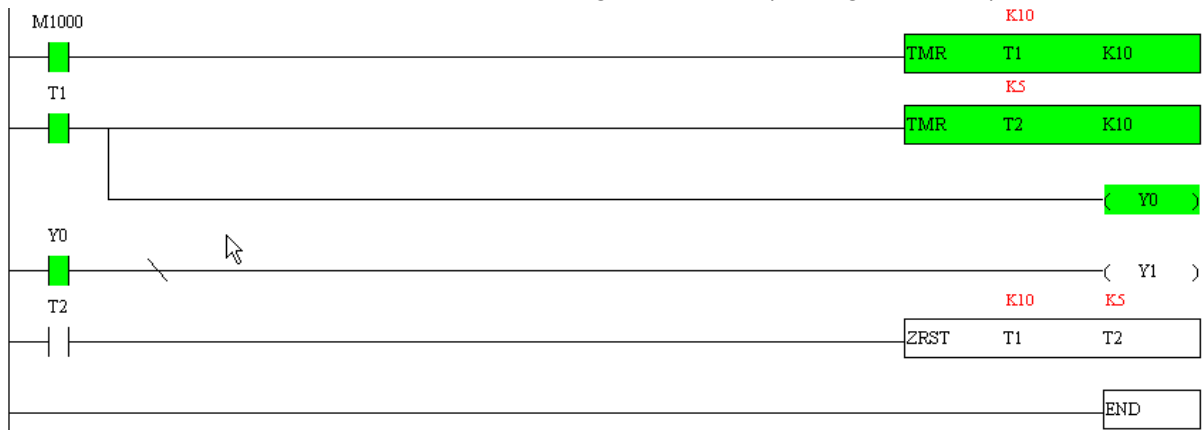

16-4 Basic principles of PLC ladder diagrams

16-4-1 Schematic diagram of PLC ladder diagram program scanning

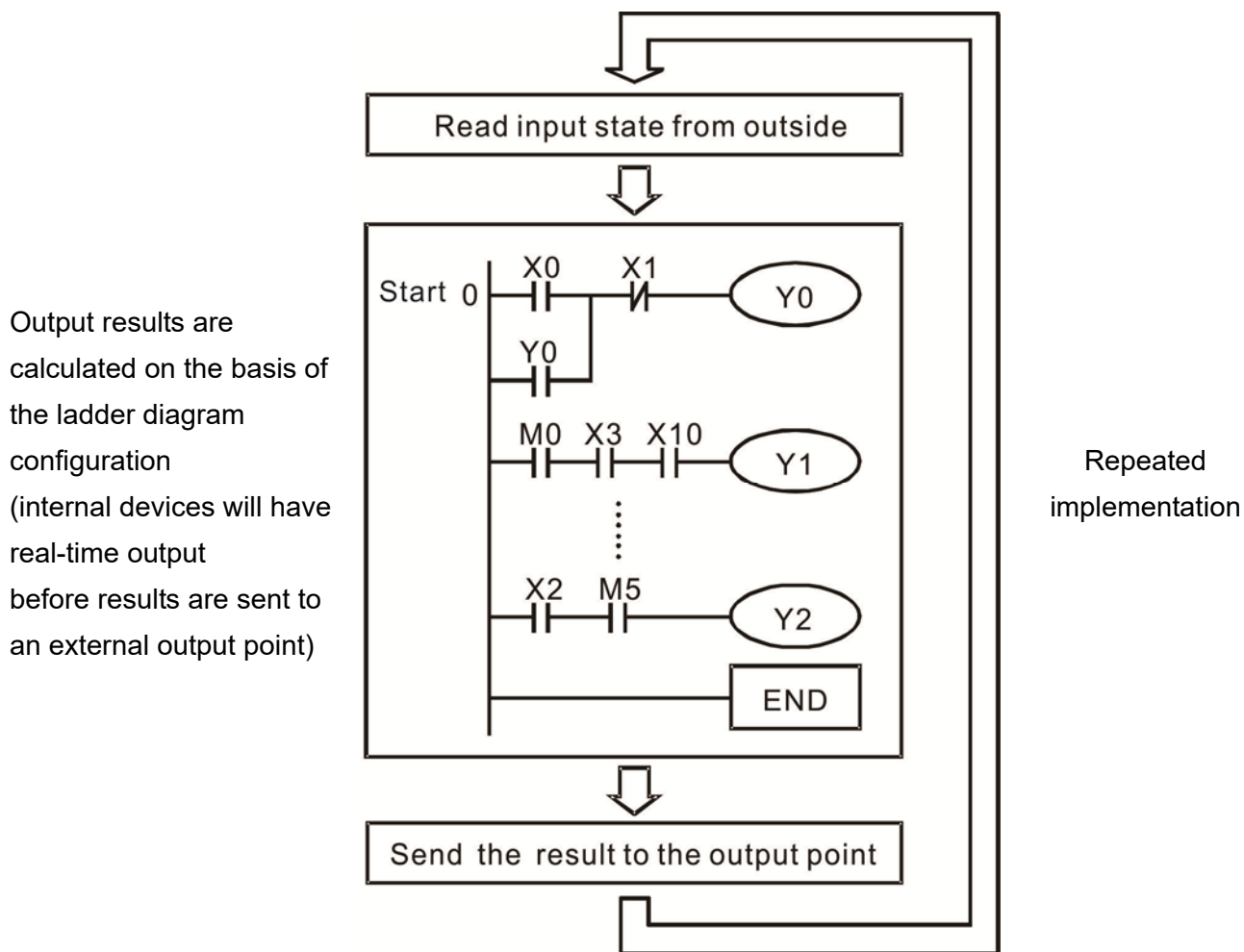

16-4-2 Introduction to ladder diagrams

Ladder diagrams comprise a graphic language widely applied in automatic control, and employs common electrical control circuit symbols. After a ladder diagram editor has been used to create a ladder pattern, PLC program designed is completed. The use of a graphic format to control processes is very intuitive, and is readily accepted by personnel who are familiar with electrical control circuit technology. Many of the basic symbols and actions in a ladder diagram comprise commonly seen electrical devices in conventional automatic control power distribution panels, such as buttons, switches, relays, timers, and counters.

Internal PLC devices: The types and quantities of internal PLC devices vary in different brands of products. Although these internal devices use the same names as conventional electrical control circuit elements such as relays, coils, and contacts, a PLC does not actually contain these physical devices, and they instead correspond to basic elements in the PLC's internal memory (bits). For instance, if a bit is 1, this may indicate that a coil is electrified, and if that bit is 0, it will indicate that the coil is not electrified. An NO contact (Normal Open, or contact a) can be used to directly read the value of the corresponding bit, and an NC contact (Normal Close, or contact b) can be used to obtain the inverse of the bit's value. Multiple relays occupy multiple bits, and 8 bits comprise one byte; two bytes comprise one word, and two words comprise a double word. When

multiple relays are processing at the same time (such as addition/subtraction or displacement, etc.), a byte, word, or double word can be used. Furthermore, a PLC contains two types of internal devices: a timer and a counter. It not only has a coil, but can count time and numerical values. Because of this, when it is necessary to process some numerical values, these values are usually in the form of bytes, words, or double words.









The various internal devices in a PLC all account for a certain quantity of storage units in the PLC's storage area. When these devices are used, the content of the corresponding storage area is read in the form of bits, bytes, or words.

Introduction to the basic internal devices in a PLC

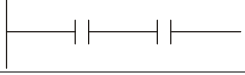
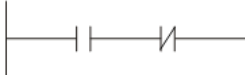
Device type	Description of Function
Input Relay	<p>An input relay constitutes the basic unit of storage in a PLC's internal memory corresponding to an external input point (which serves as a terminal connecting with an external input switch and receiving external input signals). It is driven by external input signals, to which it assigns values of 0 or 1. A program design method cannot change the input relay status, and therefore cannot rewrite the corresponding basic units of an input relay, and WPLSoft cannot be used to perform compulsory On/Off actions. A relay's contacts (contacts a and b) can be used an unlimited number of times. An input relay with no input signal must be left idle and cannot be used for some other purpose.</p> <p><input checked="" type="checkbox"/> Device indicated as: X0, X1, X7, X10, X11, etc. This device is expressed with the symbol "X," and a device's order is indicated with an octal number. Input point numbers are indicated in the main computer and in expansion devices.</p>
Output Relay	<p>An output relay constitutes the basic unit of storage in a PLC's internal memory corresponding to an external output point (which connects with an external load). It may be driven by an input relay contact, a contact on another internal device, or its own contacts. It uses one NO contact to connect with external loads or other contacts, and, like input contacts, can use the contact an unlimited number of times. An output relay with no input signal will be idle, but may be used an internal relay if needed.</p> <p><input checked="" type="checkbox"/> Device indicated as: Y0, Y1, Y7, Y10, Y11, etc. This device is expressed with the symbol "Y," and a device's order is indicated with an octal number. Output point numbers are indicated in the main computer and in expansion devices.</p>
Internal Relay	<p>Internal relays have no direct connection with the outside. These relays are auxiliary relays inside a PLC. Their function is the same as that of an auxiliary (central) relay in an electrical control circuit: Each auxiliary relay corresponding to a basic unit of internal storage; they can be driven by input relay contacts, output relay contacts, and the contacts of other internal devices. An internal auxiliary relay's contact can also be used an unlimited number of times. Internal relays have no outputs to outside, and must output via an output point.</p> <p><input checked="" type="checkbox"/> Device indicated as: M0, M1 to M799, etc. This device is expressed as the symbol "M," expressed, and its order is expressed as a decimal number.</p>
Counter	<p>A counter is used to perform counting operations. A count setting value (such as the number of pulses to be counted) must be assigned when a counter is used. A counter contains a coil, contact, and a counting storage device. When the coil goes from Off → to On, this indicates that the counter has an input pulse, and one is added to its count. There are 16 bits that can be employed by the user.</p> <p><input checked="" type="checkbox"/> Device indicated as: C0, C1 to C79, etc. This device is expressed as the symbol "C," expressed, and its order is expressed as a decimal number.</p>

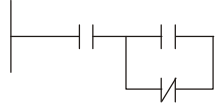
Device type	Description of Function
Timer	<p>A timer is used to complete control of timing. The timer contains a coil, contact, and a time value register. When the coil is electrified, if the preset time is reached, the contact will be actuated (contact a will close, contact b will open), and the timer's fixed value be given by the set value. Timer has a regulated clock cycle (timing units: 100 ms). As soon as power to the coil is cut off, the contact will no longer be actuated (contact a will open, contact b will close), and the original timing value will return to zero.</p> <p><input checked="" type="checkbox"/> Device indicated as: T0, T1 to T159, etc. The device is expressed as the symbol "T," and its order is expressed as a decimal number.</p>
Data register	<p>When a PLC is used to perform various types of sequence control and set time value and count value control, it most commonly perform data processing and numerical operations, and data registers are used exclusively for storage of data and various parameters. Each data register contains 16 bits of binary data, which means that it can store one word. Two data registers with adjacent numbers can be used to process double words.</p> <p><input checked="" type="checkbox"/> Device indicated as: D0, D1 to D399, etc. The device is expressed as the symbol "D," and its order is expressed as a decimal number.</p>

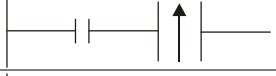
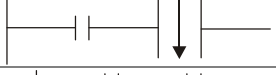
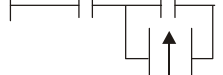
Ladder diagram images and their explanation

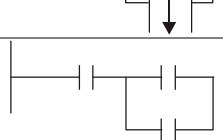
Ladder diagram structures	Explanation of commands	Command	Using Device
	NO switch, contact a	LD	X · Y · M · T · C
	NC switch, contact b	LDI	X · Y · M · T · C
	Series NO	AND	X · Y · M · T · C
	Series NC	ANI	X · Y · M · T · C
	Parallel NO	OR	X · Y · M · T · C
	Parallel NC	ORI	X · Y · M · T · C
	Positive edge-triggered switch	LDP	X · Y · M · T · C
	Negative edge-triggered switch	LDF	X · Y · M · T · C
	Positive edge-triggered series	ANDP	X · Y · M · T · C
	Negative edge-triggered series	ANDF	X · Y · M · T · C
	Positive edge-triggered parallel	ORP	X · Y · M · T · C
	Negative edge-triggered parallel	ORF	X · Y · M · T · C
	Block series	ANB	N/A

Ladder diagram structures	Explanation of commands	Command	Using Device
	Block parallel	ORB	N/A
	Multiple outputs	MPS MRD MPP	N/A
	Coil driven output commands	OUT	Y · M
	Some basic commands, applications commands	Some basic commands Applications commands	
	Inverted logic	INV	N/A

16-4-3 Overview of PLC ladder diagram editing

The program editing method begins from the left busbar and proceeds to the right busbar (the right busbar is omitted when editing using WPLSoft). Continue to the next row after completing each row; there is a maximum of 11 contacts on each row. If this is not sufficient, a continuous line will be generated to indicate the continued connection and more devices can be added. A continuous series of numbers will be generated automatically and identical input points can be used repeatedly. See figure below:

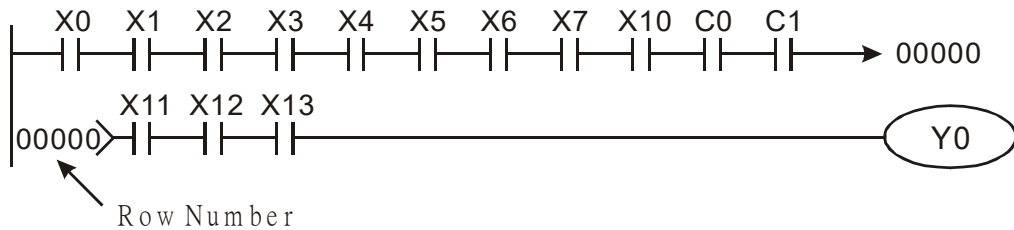

The ladder diagram programming method involves scanning from the upper left corner to the lower right corner. The coils and applications command computing box are handled in the output, and the ladder diagram is placed on the farthest right. Taking the figure below as an example, we can gradually analyze the procedural sequence of the ladder diagram. The number in the upper right corner gives the sequential order.

Explanation of command sequence

- 1 LD X0
- 2 OR M0
- 3 AND X1
- 4 LD X3
- AND M1
- ORB
- 5 LD Y1
- AND X4
- 6 LD T0
- AND M3
- ORB

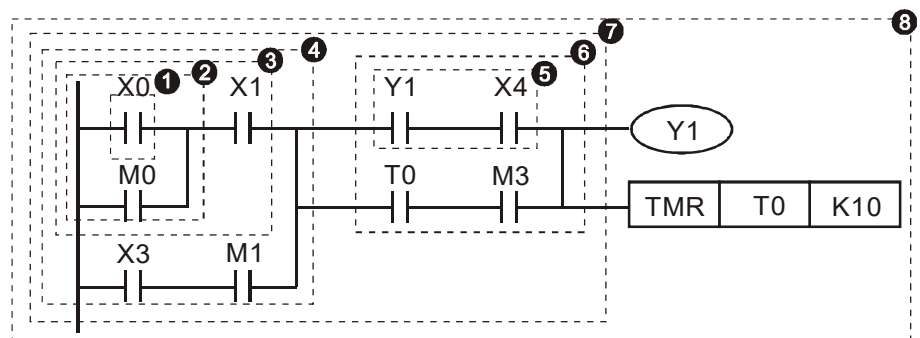

- 7 ANB
- 8 OUT Y1
- TMR T0 K10

Explanation of basic structure of ladder diagrams

LD (LDI) command: An LD or LDI command is given at the start of a block.

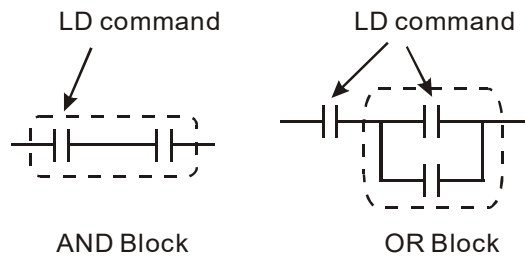

LDP and LDF have this command structure, but there are differences in their action state. LDP, LDF only act at the rising or falling edge of a conducting contact. (see figure below):

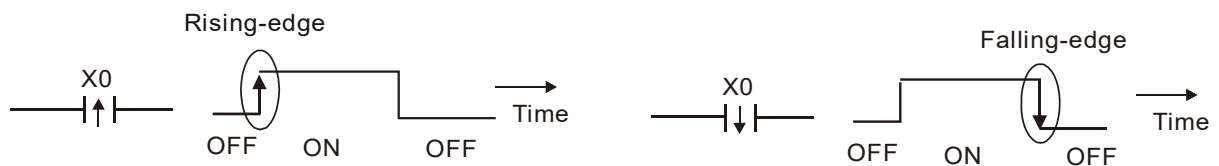

AND (ANI) command: A series configuration in which a single device is connected with one device or a block.

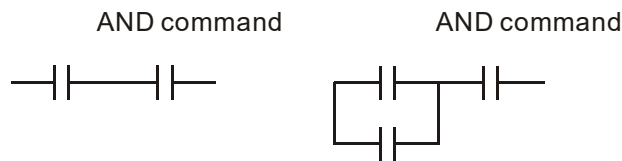

ANDP, ANDF also have structures like this, but their action occurs at the rising and falling edge.

OR (ORI) command: A single device is connected with one device or a block.

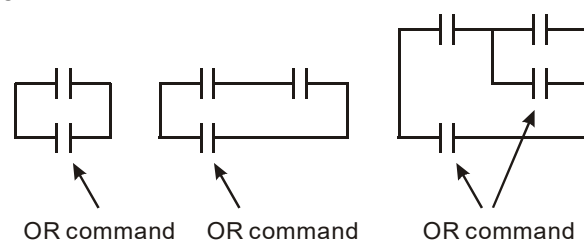

ORP, ORF also have identical structures, but their action occurs at the rising and falling edge.

ANB command: A configuration in which one block is in series with one device or block.

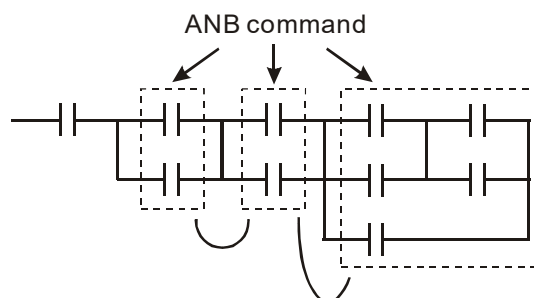

ORB command: A configuration in which one block is in parallel with one device or block.

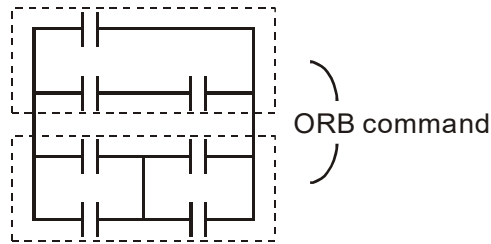

In the case of ANB and ORB operations, if a number of blocks are connected, they should be combined to form a block or network from the top down or from left to right.

MPS, MRD, MPP commands: Branching point memory for multiple outputs, enabling multiple, different outputs. The MPS command begins at a branching point, where the so-called branching point refers to the intersection of horizontal and vertical lines. We have to rely on the contact status along a single vertical line to determine whether the next contact can give a memory command. While each contact is basically able to give memory commands, in view of convenience and the PLC's capacity restrictions, this can be omitted from some places when converting a ladder diagram. The structure of the ladder diagram can be used to judge what kinds of contact memory commands are used.

MPS can be distinguished by use of the "┐" symbol; this command can be used consecutively for up to 8 times. The MRD command is read from branching point memory; because logic states along any one vertical line must be the same, in order to continue analysis of other ladder diagrams, the original contact status must be read.

MRD can be distinguished by use of the "┌" symbol. The MPP command is read from the starting state of the uppermost branching point, and it is read from the stack (pop); because it is the final command along a vertical line, it indicates that the state of the vertical line can be concluded. MPP can be distinguished by use of the "└" symbol. Although there should basically be no errors when using the foregoing analytical approach, the compiling program may sometimes omit identical state output, as shown in the following figure:

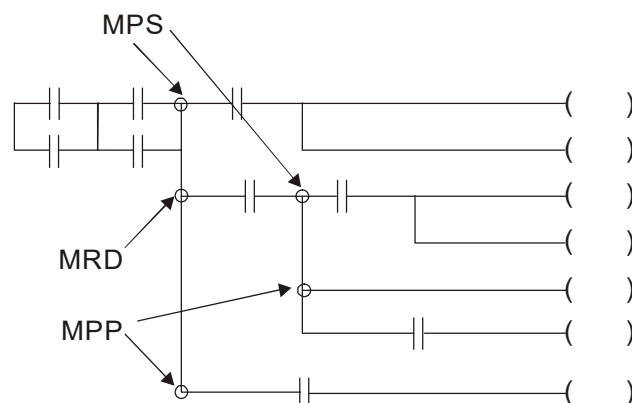

16-4-4 Commonly-used basic program design examples

Start, stop, and protection

Some applications may require a brief close or brief break using the buttons to start and stop equipment. A protective circuit, therefore, must be designed to maintain continued operation in these situations; this protective circuit may employ one of the following methods:

Example 1: Priority stop protective circuit

When the start NO contact X1=On, and the stop NC contact X2=Off, Y1=On; if X2=On at this time, coil Y1 will no longer be electrified, and this is therefore referred to as priority stop.

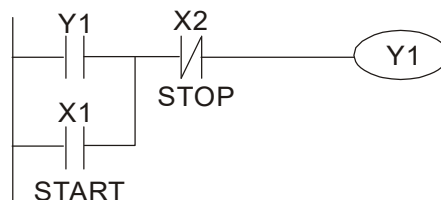

Example 2: Priority start protective circuit

When start NO contact X1=On, and the stop NC contact X2=Off, Y1=On, and coil Y1 will be electrified and protected. At this time, if X2=On, coil Y1 will still protect the contact and continue to be electrified, and this is therefore priority start.

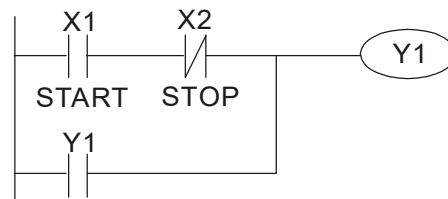

Example 3: Setting (SET) and reset (RST) command protective circuit

The following figure shows a protective circuit composed of RST and SET commands. Priority stop occurs when the RST command is placed after the SET command. Because the PLC executes programs from the top down, at the end of the program, the state of Y1 will indicate whether coil Y1 is electrified. When X1 and X2 are both actuated, Y1 will lose power, and this is therefore priority stop.

Priority start occurs when the SET command is placed after the RST command. When X1 and X2 are both actuated, Y1 will be electrified, and this is therefore priority start.

Top priority of stop

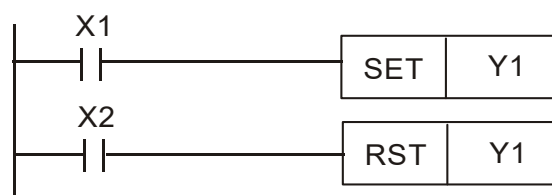

Top priority of start

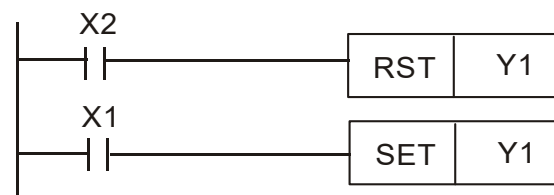

Commonly-used control circuits

Example 4: Conditional control

X1, X3 start/stop Y1 respectively. X2, X4 start/stop Y2 respectively. And all of these have protective circuits. Because Y1's NO contact is series connected with Y2's circuit, it becomes an AND condition for the actuation of Y2. The action of Y1 is therefore a condition for the action of Y2, and Y1 must be actuated before Y2 can be actuated.

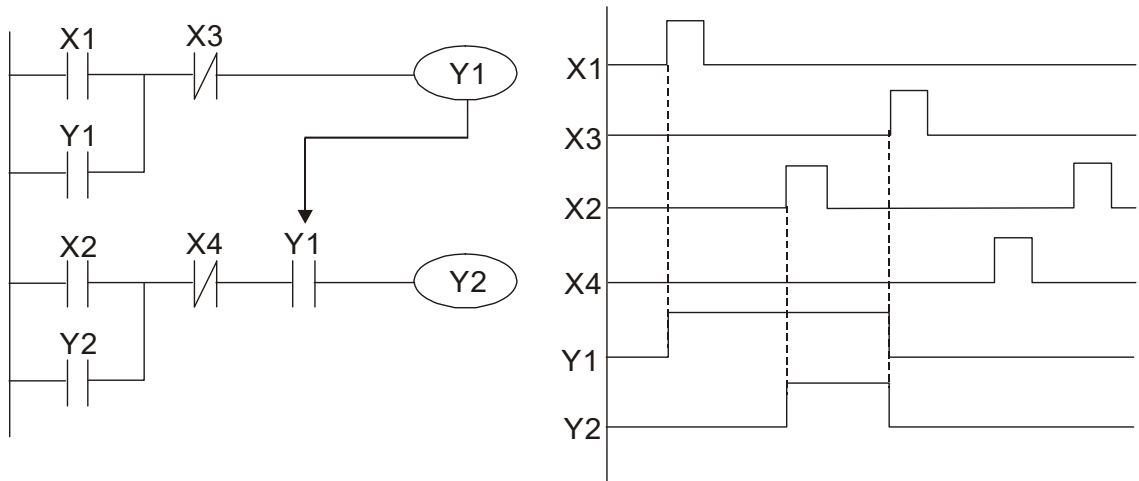

Example 5: Interlocking control

The figure below shows an interlocking control circuit. Depending on which of the start contacts X1, X2 is valid first, the corresponding output Y1 or Y2 will be actuated, and when one is actuated, the other will not be actuated. This implies that Y1 and Y2 cannot be actuated at the same time (interlocking effect). Even if both X1 and X2 are valid at the same time, because the ladder diagram program is scanned from the top down, it is impossible for Y1 and Y2 to be actuated at same time. This ladder diagram assigns priority only to Y1.

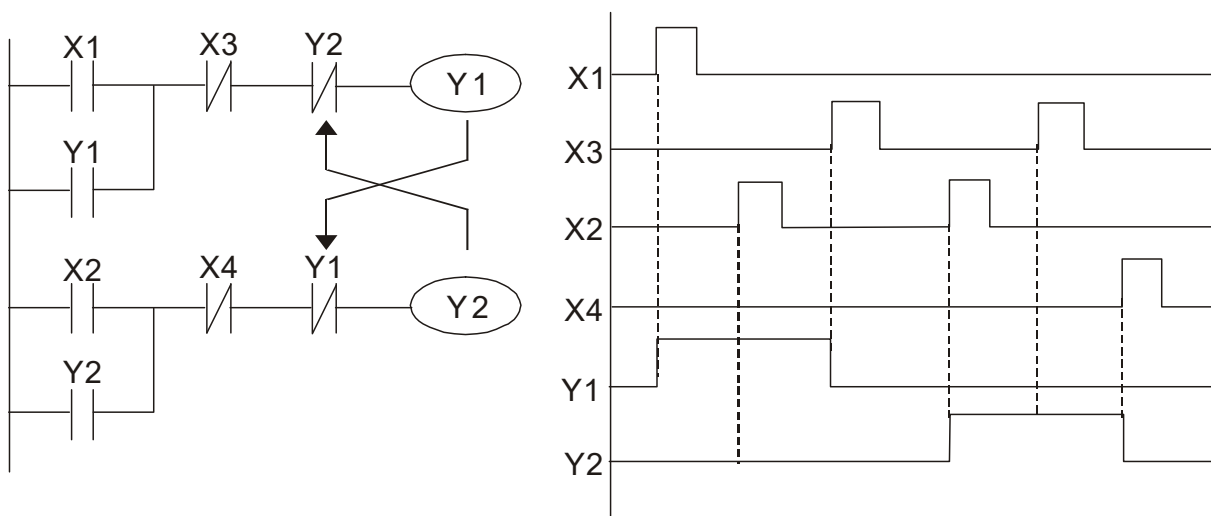

Example 6: Sequence control

If the NC contact of Y2 in the interlocking control configuration of example 5 is put in series with the Y1 circuit, so that it is an AND condition for actuation of Y1 (see figure below), not only is Y1 a condition for the actuation of Y2 in this circuit, the actuation of Y2 will also stop the actuation of Y1. This configuration confirms the actuation order of Y1 and Y2.

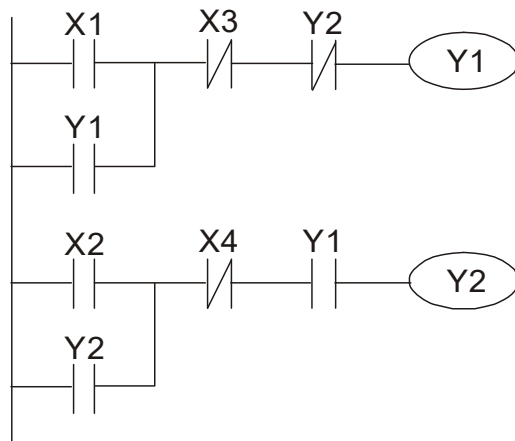

Example 7: Oscillating circuit

Oscillating circuit with a period of $\Delta T + \Delta T$

The figure below shows a very simple ladder diagram. When starting to scan the Y1 NC contact, because the Y1 coil has lost power, the Y1 NC contact will be closed. When the Y1 coil is then scanned, it will be electrified, and the output will be 1. When the Y1 NC contact is scanned in the scanning cycle, because Y1 coil is electrified, the Y1 NC contact will be open, the Y1 coil will then lose power, and the output will be 0. Following repeated scanning, the output of Y1 coil will have an oscillating waveform with a period of $\Delta T(\text{On}) + \Delta T(\text{Off})$.

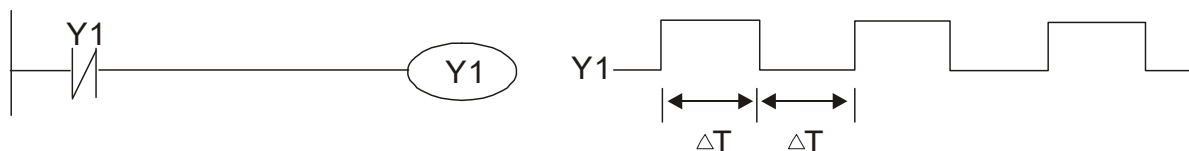

Oscillating circuit with a period of $nT + \Delta T$

The program of the ladder diagram shown below uses timer T0 to control coil Y1's electrified time. After Y1 is electrified, it causes timer T0 to close during the next scanning cycle, which will cause the output from Y1 to have the oscillating waveform shown in the figure below. Here n is the timer's decimal setting value, and T is the clock cycle of the timer.

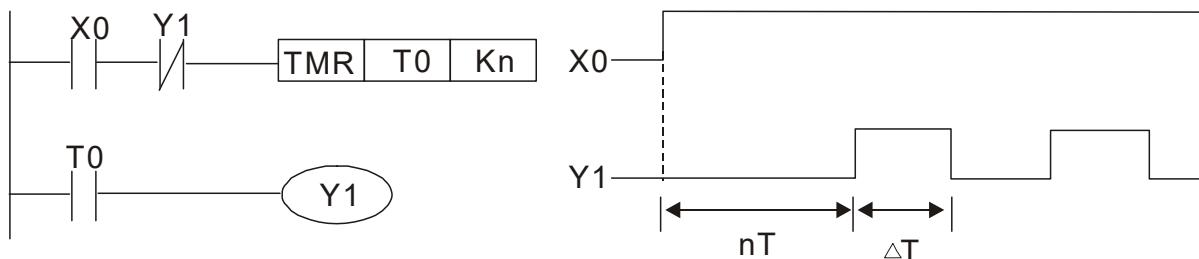

Example 8: Flashing circuit

The following figure shows an oscillating circuit of a type commonly used to cause an indicator light to flash or a buzzer to buzz. It uses two timers to control the On and Off time of Y1 coil. Here n_1 , n_2 are the timing set values of T1 and T2, and T is the clock cycle of the timer.

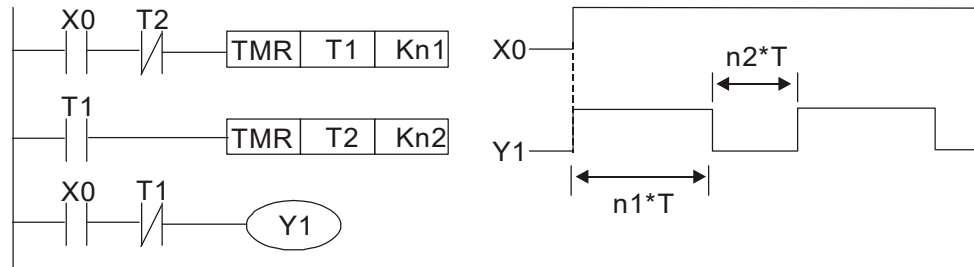

Example 9: Triggering circuit

In the figure below, a command consisting of the differential of the rising edge of X0 causes coil M0 to generate a single pulse for ΔT (length of one scanning cycle), and coil Y1 is electrified during this scanning cycle. Coil M0 loses power during the next scanning cycle, and NC contact M0 and NC contact Y1 are both closed. This causes coil Y1 to stay in an electrified state until there is another rising edge in input X0, which again causes the electrification of coil M0 and the start of another scanning cycle, while also causing coil Y1 to lose power, etc. The sequence of these actions can be seen in the figure below. This type of circuit is commonly used to enable one input to perform two actions in alternation. It can be seen from the time sequence in the figure below that when input X0 is a square wave signal with a period of T, the output of coil Y1 will be a square wave signal with a period of 2T.

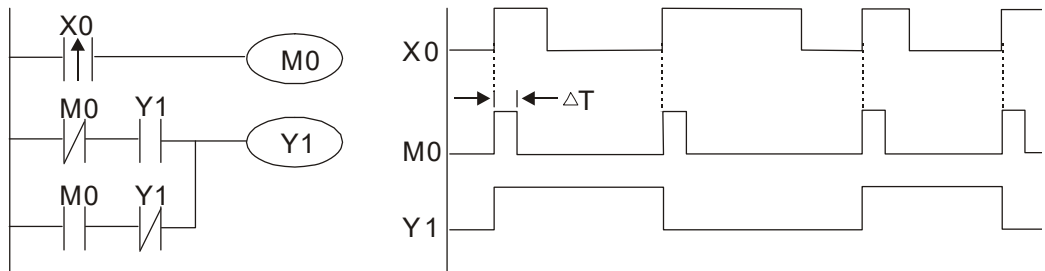

Example 10: Delay circuit

When input X0 is On, because the corresponding NC contact will be Off, the timer T10 will be in no power status, and output coil Y1 will be electrified. T10 will receive power and begin timing only after input X0 is Off, and output coil Y1 will be delayed for 100 sec. ($K1000 \times 0.1 \text{ sec.} = 100 \text{ sec.}$) before losing power; please refer to the sequence of actions in the figure below.

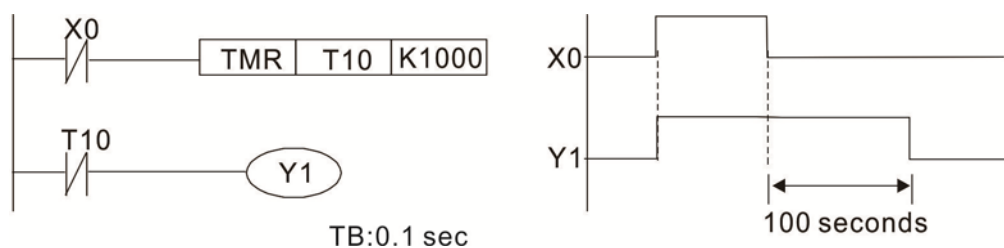

Example 11: The open/close delay circuit is composed of two timers; output Y4 will have a delay whether input X0 is On or Off.

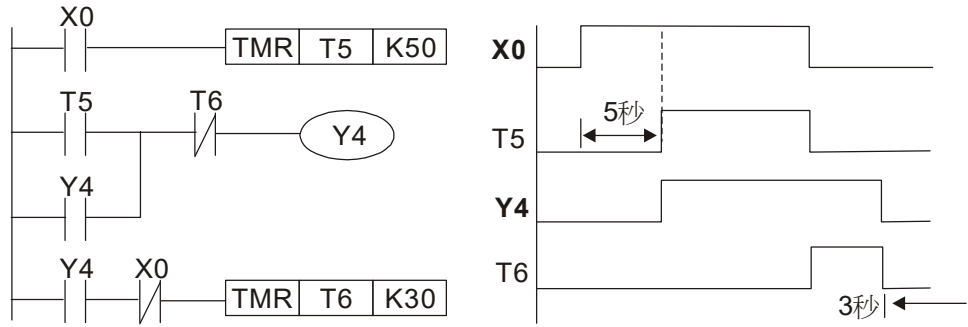

Example 12: Extended timing circuit

In the circuit in the figure on the left, the total delay time from the moment input X0 closes to the time output Y1 is electrified is $(n1+n2)*T$, where T is the clock cycle. Timers: T11, T12; clock cycle: T.

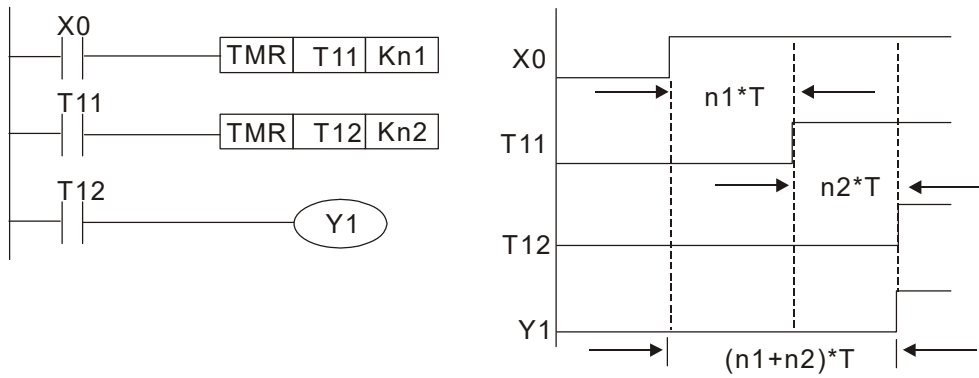

16-5 Various PLC device functions

Item	Specifications	Notes
Algorithmic control method	Program stored internally, alternating back-and-forth scanning method	
Input/output control method	When it starts again after ending (after execution to the END command), the input/output has an immediate refresh command	
Algorithmic processing speed	Basic commands (several us);	Applications command (1-several tens of us)
Programming language	Command + ladder diagram	
Program capacity	10000 steps	
Input/output terminal	Input (X): 10, output (Y): 3	This number of contacts constitutes CFP2000 input/output contacts; other devices have different correspondences

Type	Device	Item	Range	Function	
Relay bit form	X	External input relay	X0~X17, 16 points, octal number	Total 32 points Corresponds to external input point	
	Y	External output relay	Y0~Y17, 16 points, octal number		Corresponds to external output point
	M	Auxiliary Relay	General Use	M0~M799, 800 points	Total 880 points Contact can switch On/Off within the program
			Special purpose	M1000~M1079, 80 points	
	T	Timer	100ms timer	T0~T159, 160 points	Total 160 points Timers referred to by the TMR command; contact of the T with the same number will go On when the time is reached
C	Counter	16-bit counter, general use	C0~C79, 80 points	Total 80 points Counter referred to by the CNT command; contact of the C with the same number will go On when the count is reached	
Register word data	T	Current timer value		T0~T159, 160 points	The contact will be On when the time is reached
	C	Current counter value		C0~C79, 16-bit counter 80 points	The counter contact will come On when the count is reached
	D	Data Register	Used to maintain power Off	D0~D399, 400 points	Total 1400 points Used as data storage memory area
Special purpose			D1000~D1199, 200 points D2000~D2799, 800 points		
Constant	K	Decimal	Single-byte	Setting Range: K-32,768 ~ K32,767	
		Double-byte	Setting Range: K-2,147,483,648~K2,147,483,647		
	H	Hexadecimal	Single-byte	Setting Range: H0000 ~ HFFFF	
		Double-byte	Setting Range: H00000000 ~ HFFFFFFF		
Serial communications port (program write/read)			RS-485/keypad port		

Type	Device	Item	Range	Function
Input/output			Built-in three analog inputs and two analog outputs	
Function expansion module	Optional Accessories		EMC-D42A; EMC-R6AA; EMCD611A	
Communication Expansion Module	Optional Accessories		EMC-COP01,(CANopen)	

16-5-1 Introduction to device functions

Input/output contact functions

Input contact X functions: Input contact X is connected with an input device, and reads input signals entering the PLC. The number of times that contact a or b of input contact X is used in the program is not subject to restrictions. The On/Off state of input contact X will change as the input device switches On and Off; a peripheral device (WPLSoft) cannot be used to force contact X On or Off.

Output contact Y functions

The job of output contact Y is to send an On/Off signal to drive the load connected with output contact Y. Output contacts consist of two types: relays and transistors. While number of times that contact a or b of each output contact Y is used in the program is not subject to restrictions, it is recommended that the number of output coil Y be used only once in a program, otherwise the right to determine the output state when the PLC performs program scanning will be assigned to the program's final output Y circuit.

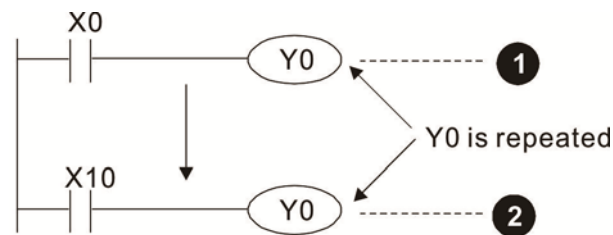

The output of Y0 will be decided by circuit ② , i.e. decided by On/Off of X10.

Numerical value, constant [K]/[H]

Constant	Single-byte	K	Decimal	K-32,768 ~ K32,767
	Double-byte			K-2,147,483,648~K2,147,483,647
	Single-byte	H	Hexadecimal	H0000 ~ HFFFF
	Double-byte			H00000000 ~ HFFFFFFFF

The PLC can use five types of numerical values to implement calculations based on its control tasks; the following is an explanation of the missions and functions of different numerical values.

Binary Number, BIN

The PLC's numerical operations and memory employ binary numbers. Binary nibbles and relevant terms are explained as follows:

Bit	Bits are the fundamental units of binary values, and have a state of either 1 or 0
Nibble	Comprised of a series of 4 bits (such as b3-b0); can be used to express a one-nibble decimal number 0-9 or hexadecimal number: 0-F.
Byte	Comprised of a series of two nibbles (i.e. 8 bits, b7-b0); can express a hexadecimal number: 00-FF.
Word	Comprised of a series of two bytes (i.e. 16 bits, b15-b0); can express a hexadecimal number with four nibbles: 0000-FFFF.
Double Word	Comprised of a series of two words (i.e. 32 bits, b31-b0); can express a hexadecimal number with eight nibbles: 00000000-FFFFFFFF

Relationship between bits, digits, nibbles, words, and double words in a binary system (see figure below):

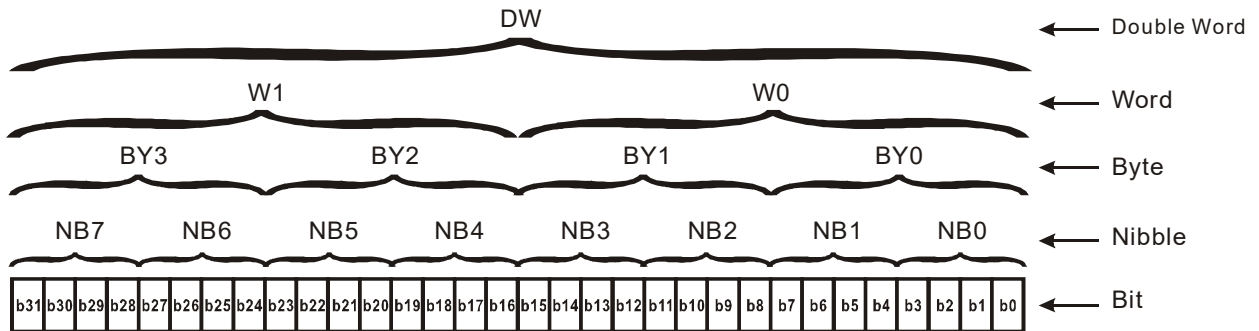

Octal Number, OCT

The external input and output terminals of a DVP-PLC are numbered using octal numbers

Example: External input: X0~X7 , X10~X17...(Device number table);

External output: Y0~Y7 , Y10~Y17...(Device number table)

Decimal Number, DEC

Decimal numbers are used for the following purposes in a PLC system:

The setting values of timer T or counter C, such as TMR C0 K50. (K constant)

The numbers of devices including M, T, C, or D, such as M10 or T30. (device number)

Used as an operand in an application command, such as MOV K123 D0. (K constant)

Binary Code Decimal, BCD

Uses one nibble or 4 bits to express the data in a decimal number; a series of 16 bits can therefore express a decimal number with 4 nibbles. Chiefly used to read the input value of a fingerwheel numerical switch input or output a numerical value to a seven-segment display driver.

Hexadecimal Number, HEX

Applications of hexadecimal numbers in a PLC system: Used as operands in application commands, such as MOV H1A2B D0. (H constant)

Constant K

Decimal numbers are usually prefixed with a "K" in a PLC system, such as K100. This indicates that it is a decimal number with a numerical value of 100.

Exceptions: K can be combined with bit device X, Y, M, or S to produce data in the form of a nibble, byte, word, or double word, such as in the case of K2Y10 or K4M100. Here K1 represents a 4-bit combination, and K2-K4 variously represent 8-, 12-, and 16-bit combinations.

Constant H

Hexadecimal numbers are usually prefixed with the letter "H" in a PLC system, such as in the case of H100, which indicates a hexadecimal number with a numerical value of 100.

Functions of auxiliary relays

Like an output relay Y, an auxiliary relay M has an output coil and contacts a and b, and the number of times they can be used in a program is unrestricted. Users can use an auxiliary relay M to configure the control circuit, but cannot use it to directly drive an external load. Auxiliary relays have the following two types of characteristics:

Ordinary auxiliary relays: Ordinary auxiliary relays will all revert to the Off state if a power outage occurs while the PLC is running, and will remain in the Off state if power is again turned down.

Special purpose auxiliary relays: Each special purpose auxiliary relay has its own specific use. Do not use any undefined special purpose auxiliary relays.

Timer functions

Timers take 100 ms as their timing units. When the timing method is an upper time limit, when the current timer value = set value, power will be sent to the output coil. Timer setting values consist of decimal K values, and the data register D can also serve as a setting value.

Actual timer setting time = timing units * set value

Counter features

Item	16-bit counter
Type	General Type
CT Direction:	Score:
Setting	0~32,767
Designation of set value	Constant K or data register D
Change in current value	When the count reaches the set value, there is no longer a count
Output contact	When the count reaches the set value, the contact comes On and stays On
Reset	The current value reverts to 0 when an RST command is executed, and the contact reverts to Off
Contact actuation	All are actuated after the end of scanning

Counter functions

When a counter's counting pulse input signal goes Off→On, if the counter's current value is equal to the set value, the output coil will come On. The setting value will be a decimal K values, and the data register D can also serve as a setting value.

16-bit counter C0-C79:

- 16-bit counter setting range: K0-K32,767. (when K0 and K1 are identical, the output contact will immediately be On during the first count.)
- The current counter value will be cleared from an ordinary counter when power is shut off to the PLC.
- If the MOV command or WPLSoft is used to transmit a value greater than the set value to the C0 current value register, when the next X1 goes from Off→On, the C0 counter contact will change to On, and the current value will change to the set value.
- A counter's setting value may be directly set using a constant K or indirectly set using the value in register D (not including special data registers D1000- D1199 or D2000 ~ D2799).
- If the set value employs a constant K, it may only be a positive number; the set value may be either a positive or a negative number if the value in data register D is used. The current counter value will change from 32,767 to -32,768 as the count continues to accumulate.

Example

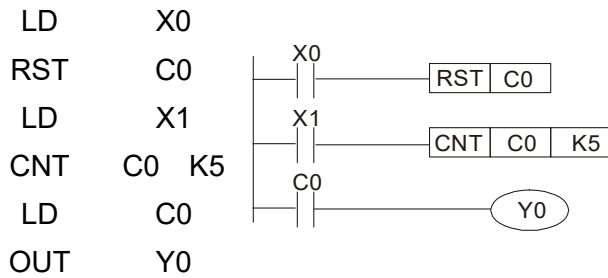

1. When X0=On and the RST command is executed, the current value of C0 will revert to 0, and the output contact will revert to Off.
2. When X1 changes from Off→On, the current value of the counter will execute an increase (add one).
3. When the count of counter C0 reaches the set value K5, the contact C0 will come On, and the current value of C0= set value =K5. Afterwards, signal C0 triggered by X1 cannot be received, and the current value of C0 will remain K5.

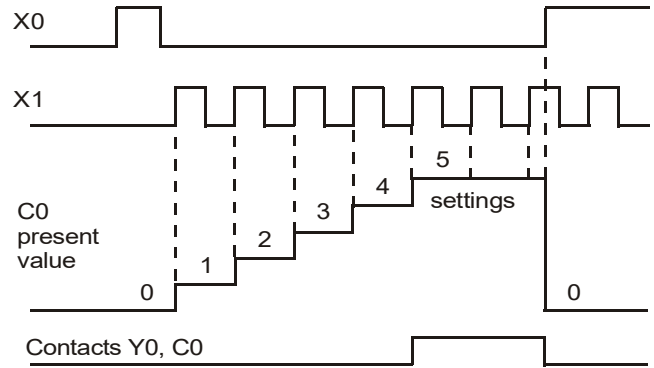

16-5-2 Introduction to special relay functions (special M)

R/W items: RO: read only function; RW: read and write function

Special M	Description of Function	R/W *
M1000	Operates monitor NO contact (contact a). NO while RUN, contact a. This contact is On while in the RUN state.	RO
M1001	Operates monitor NC contact (contact b). NC while RUN, contact b. This contact is Off while in the RUN state.	RO
M1002	Initiates a forward (the instant RUN is On) pulse. Initial pulse, contact a. Produces a forward pulse the moment RUN begins; its width = scan cycle	RO
M1003	Initiates a reverse (the instant RUN is Off) pulse. Initial pulse, contact a. Produces a reverse pulse the moment RUN ends; the pulse width = scan cycle	RO
M1004	Reserved	RO
M1005	Driver malfunction instructions	RO
M1006	Converter has no output	RO
M1007	Driver direction FWD(0)/REV(1)	RO
M1008 ~ M1010	--	--
M1011	10 ms clock pulse, 5ms On/5ms Off	RO
M1012	100 ms clock pulse, 50ms On / 50ms Off	RO
M1013	1 sec. clock pulse, 0.5s On / 0.5s Off	RO
M1014	1 min. clock pulse, 30s On / 30s Off	RO
M1015	Frequency attained (when used together with M1025)	RO

Special M	Description of Function	R/W *
M1016	Parameter read/write error	RO
M1017	Parameter write successful	RO
M1018	--	--
M1019	--	--
M1020	Zero flag	RO
M1021	Borrow flag	RO
M1022	Carry flag	RO
M1023	Divisor is 0	RO
M1024	--	--
M1025	Driver frequency = set frequency (ON) Driver frequency =0(OFF)	RW
M1026	Driver operating direction FWD(OFF)/REV(ON)	RW
M1027	Driver Reset	RW
M1028	--	--
M1029	--	--
M1030	--	--
M1031	Compulsory setting of the current PID integral value equal to D1019 (0 change, 1 valid)	RW
M1032	Compulsory definition of FREQ command after PID control	RW
M1033	--	--
M1034	Initiates CANopen real-time control	RW
M1035	Initiates internal communications control	RW
M1036	Ignore calendar error	RW
M1037	--	--
M1038	--	--
M1039	--	RW
M1040	Hardware power (Servo On)	--
M1041	--	--
M1042	Quick stop	RW
M1043	--	--
M1044	Pause (Halt)	RW
M1045	--	--
M1046	--	--
M1047	--	--
M1048	--	--
M1049	--	--
M1050	--	--
M1051	--	--
M1052	Lock frequency (lock, frequency locked at the current operating frequency)	RW
M1053	--	--
M1054	--	--
M1055	--	--
M1056	Hardware already has power (Servo On Ready)	RO
M1057	--	--
M1058	On Quick Stopping	RO
M1059	CANopen Master setting complete	RO
M1060	CANopen Currently initializing slave station	RO
M1061	CANopen Slave station initialization failure	RO
M1062	--	--
M1063	--	--
M1064	--	--
M1065	Read/write CANopen data time out	RO
M1066	Read/write CANopen data complete	RO
M1067	Read/write CANopen data successful	RO
M1068	Calendar calculation error	RO

Special M	Description of Function	R/W *
M1069	--	--
M1070	--	--
M1071	--	--
M1072 ~ M1075	--	--
M1076	Calendar time error or refresh time out	RO
M1077	485 Read/write complete	RO
M1078	485 Read-write error	RO
M1079	485 Communications time out	RO

16-5-3 Introduction to special register functions (special D)

Special D	Description of Function	R/W *
D1000	--	--
D1001	Device system program version	RO
D1002	Program capacity	RO
D1003	Total program memory content	RO
D1004 ~ D1009	--	--
D1010	Current scan time (units: 0.1 ms)	RO
D1011	Minimum scan time (units: 0.1 ms)	RO
D1012	Maximum scan time (units: 0.1 ms)	RO
D1013 ~ D1017	--	--
D1018	Current integral value	RO
D1019	Compulsory setting of PID I integral	RW
D1020	Output frequency (0.000~600.00Hz)	RO
D1021	Output current (####.#A)	RO
D1022	AI/ AO/ DI/ DO Expansion card number 0 : No expansion card 4 : AC input card (6 in) (EMC-D611A) 5 : I/O Card (4 in 2 out) (EMC-D42A) 6 : Relay card (6 out) (EMC-R6AA)	RO
D1023	Communication expansion card number 0 : No expansion card 1 : DeviceNet Slave 2 : Profibus-DP Slave 3 : CANopen Slave 4 : Modbus-TCP Slave 5 : EtherNet/IP Slave	RO
D1024 ~ D1026	--	--
D1027	PID calculation frequency command (frequency command after PID calculation)	RO
D1028	AVI1 value (0.00~100.00%)	RO
D1029	ACI value (0.0~100.00%)	RO
D1030	AVI2 value (-100.0~100.00%)	RO
D1031 ~ D1035	--	--

Special D	Description of Function	R/W *
D1036	Servo error bit	RO
D1037	Driver output frequency	RO
D1038	DC BUS voltage	RO
D1039	Output voltage	RO
D1040	Analog output value AFM1(-100.00~100.00%)	RW
D1041 ~ D1042	--	--
D1043	Can be user-defined (will be displayed on panel when parameter 00-04 is set as 28; display method is C xxx)	RW
D1044	--	-
D1045	Analog output value AFM2(-100.00~100.00%)	RW
D1046 ~ D1049	--	--
D1050	Actual Operation Mode 0 : Speed	RO
D1051	--	--
D1052	--	--
D1053	--	--
D1054	--	--
D1055	--	--
D1056	--	--
D1057	--	--
D1058	--	--
D1059	--	--
D1060	Operation Mode setting 0 : Speed	RW
D1061	485 COM1 communications time out time (ms)	RW
D1062	Torque command (torque limit in speed mode)	RW
D1063	Year (Western calendar) (display range 2000-2099) (must use KPC-CC02)	RO
D1064	Week (display range 1-7) (must use KPC-CC02)	RO
D1065	Month (display range 1-12) (must use KPC-CC02)	RO
D1066	Day (display range 1-31) (must use KPC-CC02)	RO
D1067	Hour (display range 0-23) (must use KPC-CC02)	RO
D1068	Minute (display range 0-59) (must use KPC-CC02)	RO
D1069	Second (display range 0-59) (must use KPC-CC02)	RO
D1100	Target frequency	RO
D1101	Target frequency (must be operating)	RO
D1102	Reference frequency	RO
D1103	--	--
D1104	--	--
D1105	--	--
D1106	--	--
D1107	π (Pi) Low word	RO
D1108	π (Pi) High word	RO
D1109	Random number	RO
D1110	Internal node communications number (set number of slave stations to be controlled)	RW
D1111	--	--
D1112	--	--
D1113	--	--
D1114	--	--
D1115	Internal node synchronizing cycle (ms)	RO
D1116	Internal node error (bit0 = Node 0, bit1 = Node 1,...bit7 = Node 7)	RO

Special D	Description of Function	R/W *
D1117	Internal node online correspondence (bit0 = Node 0, bit1 = Node 1,...bit7 = Node 7)	RO
D1118	--	--
D1119	--	--
D1120	Internal node 0 control command	RW
D1121	Internal node 0 mode	RW
D1122	Internal node 0 reference command L	RW
D1123	Internal node 0 reference command H	RW
D1124	--	--
D1125	--	--
D1126	Internal node 0 status	RO
D1127	Internal node 0 reference status L	RO
D1128	Internal node 0 reference status H	RO
D1129	--	--
D1130	Internal node 1 control command	RW
D1131	Internal node 1 mode	RW
D1132	Internal node 1 reference command L	RW
D1133	Internal node 1 reference command H	RW
D1134	--	--
D1135	--	--
D1136	Internal node 1 status	RO
D1137	Internal node 1 reference status L	RO
D1138	Internal node 1 reference status H	RO
D1139	--	--
D1140	Internal node 2 control command	RW
D1141	Internal node 2 mode	RW
D1142	Internal node 2 reference command L	RW
D1143	Internal node 2 reference command H	RW
D1144	--	--
D1145	--	--
D1146	Internal node 2 status	RO
D1147	Internal node 2 reference status L	RO
D1148	Internal node 2 reference status H	RO
D1149	--	--
D1150	Internal node 3 control command	RW
D1151	Internal node 3 mode	RW
D1152	Internal node 3 reference command L	RW
D1153	Internal node 3 reference command H	RW
D1154	--	--
D1155	--	--
D1156	Internal node 3 status	RO
D1157	Internal node 3 reference status L	RO
D1158	Internal node 3 reference status H	RO
D1159	--	--
D1160	Internal node 4 control command	RW
D1161	Internal node 4 mode	RW
D1162	Internal node 4 reference command L	RW
D1163	Internal node 4 reference command H	RW
D1164	--	--
D1165	--	--
D1166	Internal node 4 status	RO
D1167	Internal node 4 reference status L	RO
D1168	Internal node 4 reference status H	RO
D1169	--	--

Special D	Description of Function	R/W *
D1170	Internal node 5 control command	RW
D1171	Internal node 5 mode	RW
D1172	Internal node 5 reference command L	RW
D1173	Internal node 5 reference command H	RW
D1174	--	RW
D1175	--	--
D1176	Internal node 5 status	--
D1177	Internal node 5 reference status L	RO
D1178	Internal node 5 reference status H	RO
D1179	--	--
D1180	Internal node 6 control command	RW
D1181	Internal node 6 mode	RW
D1182	Internal node 6 reference command L	RW
D1183	Internal node 6 reference command H	RW
D1184	--	--
D1185	--	--
D1186	Internal node 6 status	RO
D1187	Internal node 6 reference status L	RO
D1188	Internal node 6 reference status H	RO
D1189	--	--
D1190	Internal node 7 control command	RW
D1191	Internal node 7 mode	RW
D1192	Internal node 7 reference command L	RW
D1193	Internal node 7 reference command H	RW
D1194	--	--
D1195	--	--
D1196	Internal node 7 status	RO
D1197	Internal node 7 reference status L	RO
D1198	Internal node 7 reference status H	RO
D1199	--	--

The following is CANopen Master's special D (can be written only with PLC in Stop state)

n = 0 ~ 7

Special D	Description of Function	PDO Map	Power off Memory	Default:	R/W
D1070	Channel opened by CANopen initialization (bit0=Machine code0	NO	NO	0	R
D1071	Error channel occurring in CANopen initialization process (bit0=Machine code0	NO	NO	0	R
D1072	Reserved	-	-		-
D1073	CANopen break channel (bit0=Machine code0	NO	NO		R
D1074	Error code of master error 0: No error 1: Slave station setting error 2: Synchronizing cycle setting error (too small)	NO	NO	0	R
D1075	Reserved	-	-		-
D1076	SDO error message (main index value)	NO	NO		R
D1077	SDO error message (secondary index value)	NO	NO		R
D1078	SDO error message (error code)	NO	NO		R
D1079	SDO error message (error code)	NO	NO		R
D1080	Reserved	-	-		-

Special D	Description of Function	PDO Map	Power off Memory	Default:	R/W
D1081 ~ D1086	Reserved	-	-		-
D1087 ~ D1089	Reserved	-	-		-
D1090	Synchronizing cycle setting	NO	YES	4	RW
D1091	Sets slave station On or Off (bit 0-bit 7 correspond to slave stations number 0-7)	NO	YES	FFFFH	RW
D1092	Delay before start of initialization	NO	YES	0	RW
D1093	Break time detection	NO	YES	1000ms	RW
D1094	Break number detection	NO	YES	3	RW
D1095 ~ D1096	Reserved	-	-		-
D1097	Corresponding real-time transmission type (PDO) Setting range: 1~240	NO	YES	1	RW
D1098	Corresponding real-time receiving type (PDO) Setting range: 1~240	NO	YES	1	RW
D1099	Initialization completion delay time Setting range: 1 to 60000 sec	NO	YES	15 sec.	RW
D2000+100*n	Station number n of slave station Setting range: 0~127 0: No CANopen function	NO	YES	0	RW

The CFP2000 supports 8 slave stations under the CANopen protocol; each slave station occupies 100 special D locations; stations are numbered 1-8, total of 8 stations.

Explanation of slave station number and	Slave station no. 1	Slave station no. 2	Slave station no. 3	Slave station no. 8
	D2000 D2001 ~ D2099	D2100 D2101 ~ D2199	D2200 D2201 ~ D2299	D2700 D2701 ~ D2799
	Node ID Slave station no. 1 torque restrictions ~ Address 4(H) corresponding to receiving channel 4	Node ID Slave station no. 2 torque restrictions ~ Address 4(H) corresponding to receiving channel 4	Node ID Slave station no. 3 torque restrictions ~ Address 4(H) corresponding to receiving channel 4	Node ID Slave station no. 8 torque restrictions ~ Address 4(H) corresponding to receiving channel 4

1. The range of n is 0-7
2. ●Indicates PDOTX, ▲Indicates PDORX; unmarked special D can be refreshed using the CANFLS command

Special D	Description of Function	Default:	R/W
D2000+100*n	Station number n of slave station Setting range: 0~127 0: No CANopen function	0	RW
D2002+100*n	Manufacturer code of slave station number n (L)	0	R
D2003+100*n	Manufacturer code of slave station number n (H)	0	R
D2004+100*n	Manufacturer's product code of slave station number n (L)	0	R
D2005+100*n	Manufacturer's product code of slave station number n (H)	0	R

Basic definitions

Special D	Description of Function	Default:	CAN Index	PDO Default:				R/W
				1	2	3	4	
D2006+100*n	Communications break handling method of slave station number n	0	6007H-0010H					RW
D2007+100*n	Error code of slave station number n error	0	603FH-0010H					R
D2008+100*n	Control word of slave station number n	0	6040H-0010H	●		●	●	RW
D2009+100*n	Status word of slave station number n	0	6041H-0010H	▲		▲	▲	R
D2010+100*n	Control mode of slave station number n	2	6060H-0008H					RW
D2011+100*n	Actual mode of slave station number n	2	6061H-0008H					R

Velocity Control

Slave station number n=0-7

Special D	Description of Function	Default:	CAN Index	PDO Default:				R/W
				1	2	3	4	
D2001+100*n	Torque restriction on slave station number n	0	6072H-0010H					RW
D2012+100*n	Target speed of slave station number n	0	6042H-0010H	●				RW
D2013+100*n	Actual speed of slave station number n	0	6043H-0010H	▲				R
D2014+100*n	Error speed of slave station number n	0	6044H-0010H					R
D2015+100*n	Acceleration time of slave station number n	1000	604FH-0020H					R
D2016+100*n	Deceleration time of slave station number n	1000	6050H-0020H					RW

20XXH correspondences: MI/ MO/ AI/ AO

Slave station number n=0-7

Special D	Description of Function	Default:	CAN Index	PDO Default:				R/W
				1	2	3	4	
D2026+100*n	MI status of slave station number n	0	2026H-0110H	▲				RW
D2027+100*n	MO setting of slave station number n	0	2026H-4110H	●				RW
D2028+100*n	AI1 status of slave station number n	0	2026H-6110H	▲				RW
D2029+100*n	AI2 status of slave station number n	0	2026H-6210H	▲				RW
D2030+100*n	AI3 status of slave station number n	0	2026H-6310H	▲				RW
D2031+100*n	AO1 status of slave station number n	0	2026H-A110H	●				RW
D2032+100*n	AO2 status of slave station number n	0	2026H-A210H	●				RW
D2033+100*n	AO3 status of slave station number n	0	2026H-A310H	●				RW

PDO reflection length setting:

Special D	Description of Function	Default:	R/W
D2034+100*n	Real-time transmission setting of slave station number n	000AH	RW
D2067+100*n	Real-time reception setting of slave station number n	0000H	RW

16-5-4 PLC Communication address

Device	Range	Type	Address (Hex)
X	00~37 (Octal)	bit	0400~041F
Y	00~37 (Octal)	bit	0500~051F
T	00~159	bit/word	0600~069F
M	000~799	bit	0800~0B1F
M	1000~1079	bit	0BE8~0C37
C	0~79	bit/word	0E00~0E47
D	00~399	word	1000~118F
D	1000~1099	word	13E8~144B
D	2000~2799	word	17D0~1AEF

Command code that can be used

Function Code	Description of Function	Function target
01	Coil status read	Y, M, T, C
02	Input status read	X,Y,M,T,C
03	Read single unit of data	T,C,D
05	Compulsory single coil status change	Y,M,T,C
06	Write single unit of data	T,C,D
0F	Compulsory multiple coil status change	Y,M,T,C
10	Write multiple units of data	T,C,D

 **NOTE**

When PLC functions have been activated, the CFP2000 can match PLC and driver parameters; this method employs different addresses, drivers (default station number is 1, PLC sets station number as 2)

16-6 Introduction to the Command Window

16-6-1 Overview of basic commands

Ordinary commands

Command code	Function	OPERAND	Execution speed (us)
LD	Load contact a	X、Y、M、T、C	0.8
LDI	Load contact b	X、Y、M、T、C	0.8
AND	Connect contact a in series	X、Y、M、T、C	0.8
ANI	Connect contact b in series	X、Y、M、T、C	0.8
OR	Connect contact a in parallel	X、Y、M、T、C	0.8
ORI	Connect contact b in parallel	X、Y、M、T、C	0.8
ANB	Series circuit block	N/A	0.3
ORB	Parallel circuit block	N/A	0.3
MPS	Save to stack	N/A	0.3
MRD	Stack read (pointer does not change)	N/A	0.3
MPP	Read stack	N/A	0.3

Output command

Command code	Function	OPERAND	Execution speed (us)
OUT	Drive coil	Y、M	1
SET	Action continues (ON)	Y、M	1
RST	Clear contact or register	Y、M、T、C、D	1.2

Timer, counter

Command code	Function	OPERAND	Execution speed (us)
TMR	16-bit timer	T-K or T-D commands	1.1
CNT	16-bit counter	C-K or C-D (16-bit)	0.5

Main control command

Command code	Function	OPERAND	Execution speed (us)
MC	Common series contact connection	N0~N7	0.4
MCR	Common series contact release	N0~N7	0.4

Contact rising edge/falling edge detection command

Command code	Function	OPERAND	Execution speed (us)
LDP	Start of forward edge detection action	X、Y、M、T、C	1.1
LDF	Start of reverse edge detection action	X、Y、M、T、C	1.1
ANDP	Forward edge detection series connection	X、Y、M、T、C	1.1
ANDF	Reverse edge detection series connection	X、Y、M、T、C	1.1
ORP	Forward edge detection parallel connection	X、Y、M、T、C	1.1
ORF	Reverse edge detection parallel connection	X、Y、M、T、C	1.1

Upper/lower differential output commands

Command code	Function	OPERAND	Execution speed (us)
PLS	Upper differential output	Y、M	1.2
PLF	Lower differential output	Y、M	1.2

Stop command

Command code	Function	OPERAND	Execution speed (us)
END	Program conclusion	N/A	0.2

Other commands

Command code	Function	OPERAND	Execution speed (us)
NOP	No action	N/A	0.2
INV	Inverse of operation results	N/A	0.2
P	Index	P	0.3

16-6-2 Detailed explanation of basic commands

Command	Function					
LD	Load contact a					
Operand	X0~X17	Y0~Y17	M0~M799	T0~159	C0~C79	D0~D399
	✓	✓	✓	✓	✓	—

Explanation The LD command is used for contact a starting at the left busbar or contact a starting at a contact circuit block; its function is to save current content and save the acquired contact status in the cumulative register.

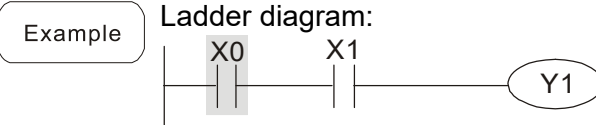

Command code:	Description:
LD X0	Load Contact a of X0
AND X1	Create series connection to contact a of X1
OUT Y1	Drive Y1 coil

Command	Function					
LDI	Load contact b					
Operand	X0~X17	Y0~Y17	M0~M799	T0~159	C0~C79	D0~D399
	✓	✓	✓	✓	✓	—

Explanation The LDI command is used for contact b starting at the left busbar or contact b starting at a contact circuit block; its function is to save current content and save the acquired contact status in the cumulative register.

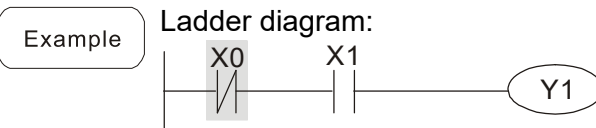

Command code:	Description:
LDI X0	Load Contact b of X0
AND X1	Create series connection to contact a of X1
OUT Y1	Drive Y1 coil

Command	Function					
AND	Connect contact a in series					
Operand	X0~X17	Y0~Y17	M0~M799	T0~159	C0~C79	D0~D399
	✓	✓	✓	✓	✓	—

Explanation The AND command is used to create a series connection to contact a; first reads current status of the designated series contact and logical operation results before contact in order to perform "AND" operation; saves results in cumulative register.

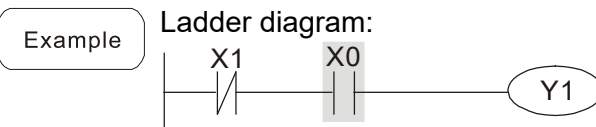

Command code:	Description:
LDI X1	Load Contact b of X1
AND X0	Create series connection to contact a of X0
OUT Y1	Drive Y1 coil

Command	Function					
ANI	Connect contact b in series					
Operand	X0~X17	Y0~Y17	M0~M799	T0~159	C0~C79	D0~D399
	✓	✓	✓	✓	✓	—

Explanation

The ANI command is used to create a series connection to contact b; its function is to first read current status of the designated series contact and logical operation results before contact in order to perform "AND" operation; saves results in cumulative register.

Example

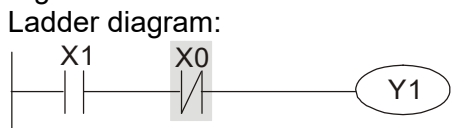

Command code:	Description:
LD X1	Load Contact a of X1
ANI X0	Create series connection to contact b of X0
OUT Y1	Drive Y1 coil

Command	Function					
OR	Connect contact a in parallel					
Operand	X0~X17	Y0~Y17	M0~M799	T0~159	C0~C79	D0~D399
	✓	✓	✓	✓	✓	—

Explanation

The OR command is used to establish a parallel connection to contact a; its function is to first read current status of the designated series contact and logical operation results before contact in order to perform "OR" operation; saves results in cumulative register.

Example

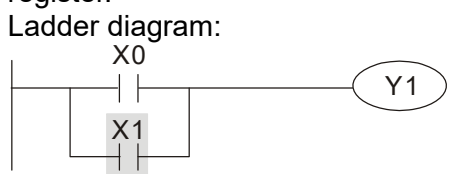

Command code:	Description:
LD X0	Load Contact a of X0
OR X1	Create series connection to contact a of X1
OUT Y1	Drive Y1 coil

Command	Function					
ORI	Connect contact b in parallel					
Operand	X0~X17	Y0~Y17	M0~M799	T0~159	C0~C79	D0~D399
	✓	✓	✓	✓	✓	—

Explanation

The ORI command is used to establish a parallel connection to contact a; its function is to first read current status of the designated series contact and logical operation results before contact in order to perform "OR" operation; saves results in cumulative register.

Example

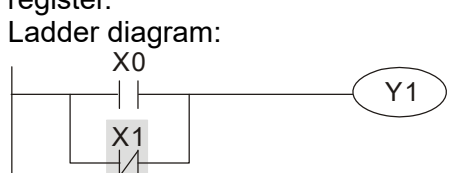

Command code:	Description:
LD X0	Load Contact a of X0
ORI X1	Create series connection to contact b of X1
OUT Y1	Drive Y1 coil

Command	Function
ANB	Series circuit block
Operand	N/A

Explanation

ANB performs an "AND" operation on the previously saved logic results and the current cumulative register content.

Example

Ladder diagram:

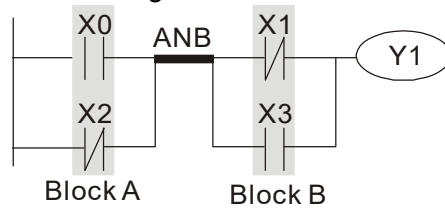

Command code:

Description:

LD	X0	Load Contact a of X0
ORI	X2	Establish parallel connection to contact b of X2
LDI	X1	Load Contact b of X1
OR	X3	Establish parallel connection to contact a of X3
ANB		Series circuit block
OUT	Y1	Drive Y1 coil

Command	Function
ORB	Parallel circuit block
Operand	N/A

Explanation

ORB performs an "OR" operation on the previously saved logic results and the current cumulative register content.

Example

Ladder diagram:

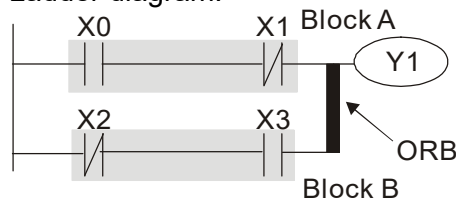

Command code:

Description:

LD	X0	Load Contact a of X0
ANI	X1	Establish parallel connection to contact b of X1
LDI	X2	Load Contact b of X2
AND	X3	Establish parallel connection to contact a of X3
ORB		Parallel circuit block
OUT	Y1	Drive Y1 coil

Command	Function
MPS	Save to stack
Operand	N/A

Explanation

Save current content of cumulative register to the stack. (Add one to stack pointer)

Command	Function
MRD	Read stack (pointer does not change)
Operand	N/A

Explanation

Reads stack content and saves to cumulative register. (Stack pointer does not change)

Command	Function																															
MPP	Read stack																															
Operand	N/A																															
Explanation	Retrieves result of previously-save logical operation from the stack, and saves to cumulative register. (Subtract one from stack pointer)																															
Example	<p>Ladder diagram:</p>	<p>Command code: Description:</p> <table border="1"> <tr> <td>LD</td> <td>X0</td> <td>Load Contact a of X0</td> </tr> <tr> <td>MPS</td> <td></td> <td>Save to stack</td> </tr> <tr> <td>AND</td> <td>X1</td> <td>Create series connection to contact a of X1</td> </tr> <tr> <td>OUT</td> <td>Y1</td> <td>Drive Y1 coil</td> </tr> <tr> <td>MRD</td> <td></td> <td>Read stack (pointer does not change)</td> </tr> <tr> <td>AND</td> <td>X2</td> <td>Create series connection to contact a of X2</td> </tr> <tr> <td>OUT</td> <td>M0</td> <td>Drive M0 coil</td> </tr> <tr> <td>MPP</td> <td></td> <td>Read stack</td> </tr> <tr> <td>OUT</td> <td>Y2</td> <td>Drive Y2 coil</td> </tr> <tr> <td>END</td> <td></td> <td>Program conclusion</td> </tr> </table>	LD	X0	Load Contact a of X0	MPS		Save to stack	AND	X1	Create series connection to contact a of X1	OUT	Y1	Drive Y1 coil	MRD		Read stack (pointer does not change)	AND	X2	Create series connection to contact a of X2	OUT	M0	Drive M0 coil	MPP		Read stack	OUT	Y2	Drive Y2 coil	END		Program conclusion
LD	X0	Load Contact a of X0																														
MPS		Save to stack																														
AND	X1	Create series connection to contact a of X1																														
OUT	Y1	Drive Y1 coil																														
MRD		Read stack (pointer does not change)																														
AND	X2	Create series connection to contact a of X2																														
OUT	M0	Drive M0 coil																														
MPP		Read stack																														
OUT	Y2	Drive Y2 coil																														
END		Program conclusion																														

Command	Function																						
OUT	Drive coil																						
Operand	X0~X17	Y0~Y17	M0~M799	T0~159	C0~C79	D0~D399																	
	—	✓	✓	—	—	—																	
Explanation	Outputs result of logical operation before OUT command to the designated element. Coil contact action:																						
	<table border="1"> <thead> <tr> <th rowspan="3">Result:</th> <th colspan="3">Out command</th> </tr> <tr> <th rowspan="2">Coil</th> <th colspan="2">Access Point:</th> </tr> <tr> <th>Contact a (NO)</th> <th>Contact b (NC)</th> </tr> </thead> <tbody> <tr> <td>FALSE</td> <td>Off</td> <td>Not conducting</td> <td>Conducting</td> </tr> <tr> <td>TRUE</td> <td>On</td> <td>Conducting</td> <td>Not conducting</td> </tr> </tbody> </table>					Result:	Out command			Coil	Access Point:		Contact a (NO)	Contact b (NC)	FALSE	Off	Not conducting	Conducting	TRUE	On	Conducting	Not conducting	
Result:	Out command																						
	Coil	Access Point:																					
		Contact a (NO)	Contact b (NC)																				
FALSE	Off	Not conducting	Conducting																				
TRUE	On	Conducting	Not conducting																				
Example	<p>Ladder diagram:</p>	<p>Command code: Description:</p> <table border="1"> <tr> <td>LD</td> <td>X0</td> <td>Load Contact b of X0</td> </tr> <tr> <td>AND</td> <td>X1</td> <td>Establish parallel connection to contact a of X1</td> </tr> <tr> <td>OUT</td> <td>Y1</td> <td>Drive Y1 coil</td> </tr> </table>	LD	X0	Load Contact b of X0	AND	X1	Establish parallel connection to contact a of X1	OUT	Y1	Drive Y1 coil												
LD	X0	Load Contact b of X0																					
AND	X1	Establish parallel connection to contact a of X1																					
OUT	Y1	Drive Y1 coil																					

Command	Function										
SET	Action continues (ON)										
Operand	X0~X17	Y0~Y17	M0~M799	T0~159	C0~C79	D0~D399					
	—	✓	✓	—	—	—					
Explanation	When the SET command is driven, the designated element will be set as On, and will be maintained in an On state, regardless of whether the SET command is still driven. The RST command can be used to set the element as Off.										
Example	<p>Ladder diagram:</p>	<p>Command code: Description:</p> <table border="1"> <tr> <td>LD</td> <td>X0</td> <td>Load Contact a of X0</td> </tr> <tr> <td>AN</td> <td>Y0</td> <td>Establish parallel connection to contact b of Y0</td> </tr> <tr> <td>SET</td> <td>Y1</td> <td>Action continues (ON)</td> </tr> </table>	LD	X0	Load Contact a of X0	AN	Y0	Establish parallel connection to contact b of Y0	SET	Y1	Action continues (ON)
LD	X0	Load Contact a of X0									
AN	Y0	Establish parallel connection to contact b of Y0									
SET	Y1	Action continues (ON)									

Command	Function					
RST	Clear contact or register					
Operand	X0~X17	Y0~Y17	M0~M799	T0~159	C0~C79	D0~D399
	—	✓	✓	✓	✓	✓

Explanation

When the RST command is driven, the action of the designated element will be as follows:

Element	Mode
Y, M	Both coil and contact will be set as Off.
T, C	The current timing or count value will be set as 0, and both the coil and contact will be set as Off.
D	The content value will be set as 0.

If the RST command has not been executed, the status of the designated element will remain unchanged.

Example

Ladder diagram:



Command code:

Description:

LD	X0	Load Contact a of X0
RST	Y5	Clear contact or register

Command	Function	
TMR	16-bit timer	
Operand	T-K	T0~T159 , K0~K32,767
	T-D	T0~T159 , D0~D399

Explanation

When the TMR command is executed, the designated timer coil will be electrified, and the timer will begin timing. The contact's action will be as follows when the timing value reaches the designated set value (timing value \geq set value):

NO (Normally Open) contact	Closed
NC (Normally Close) contact	Open

If the RST command has not been executed, the status of the designated element will remain unchanged.

Example

Ladder diagram:

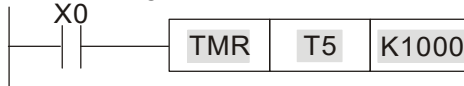

Command code:

Description:

LD	X0	Load Contact a of X0
TMR	T5 K1000	T5 timer Set value as K1000

Command	Function	
CNT	16-bit counter	
Operand	C-K	C0~C79 , K0~K32,767
	C-D	C0~C79 , D0~D399

Explanation

When the CNT command is executed from Off→On, this indicates that the designated counter coil goes from no power → electrified, and 1 will be added to the counter's count value; when the count reaches the designated value (count value = set value), the contact will have the following action:

NO (Normally Open) contact	Closed
NC (Normally Close) contact	Open

After the count value has been reached, the contact and count value will both remain unchanged even if there is continued count pulse input. Please use the RST command if you wish to restart or clear the count.

Example

Ladder diagram:

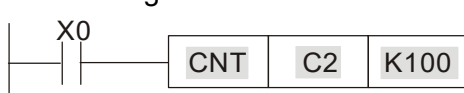

Command code:

Description:

LD	X0	Load Contact a of X0
CNT	C2 K100	C2counter Set value as K100

Command	Function
MC/MCR	Connect/release a common series contact
Operand	N0~N7

Explanation MC is the main control initiation command, and any commands between MC and MCR will be executed normally. When the MC command is Off, any commands between MC and MCR will act as follows:

Determination of commands	Description
Ordinary timer	The timing value will revert to 0, the coil will lose power, and the contact will not operate
Counter	The coil will lose power, and the count value and contact will stay in their current state
Coil driven by OUT command	None receive power
Elements driven by SET, RST commands	Will remain in their current state
Applications commands	None are actuated

MCR is the main control stop command, and is placed at the end of the main control program. There may not be any contact commands before the MCR command. The MC-MCR main control program commands support a nested program structure with a maximum only 8 levels; use in the order N0~N7, please refer to the following program:

Example

Ladder diagram:

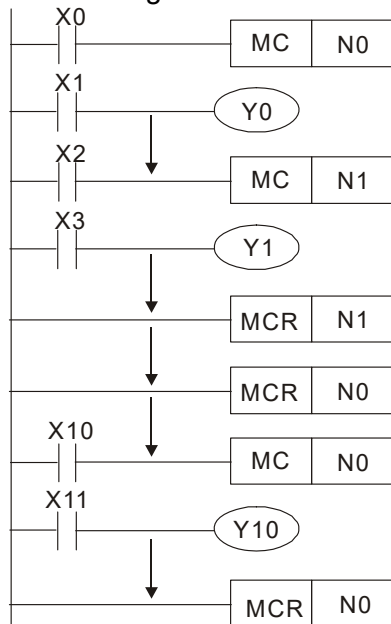

Command code: Description:

LD	X0	Load Contact a of X0
MC	N0	Connection of N0 common series contact
LD	X1	Load Contact a of X1
OUT	Y0	Drive Y0 coil
:		
LD	X2	Load Contact a of X2
MC	N1	Connection of N1 common series contact
LD	X3	Load Contact a of X3
OUT	Y1	Drive Y1 coil
:		
MCR	N1	Release N1 common series contact
:		
MCR	N0	Release N0 common series contact
:		
LD	X10	Load Contact a of X10
MC	N0	Connection of N0 common series contact
LD	X11	Load Contact a of X11
OUT	Y10	Drive Y10 coil
:		
MCR	N0	Release N0 common series contact

Command	Function					
LDP	Start of forward edge detection action					
Operand	X0~X17	Y0~Y17	M0~M799	T0~159	C0~C79	D0~D399
	✓	✓	✓	✓	✓	—

Explanation The LDP command has the same usage as LD, but its action is different; its function is to save current content, while also saving the detected state of the rising edge of the contact to the cumulative register.

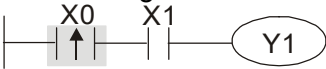
Example Ladder diagram: 

Command code:	Description:
LDP X0	Start of X0 forward edge detection action
AND X1	Create series connection to contact a of X1
OUT Y1	Drive Y1 coil

Remark Please refer to the function specifications table for each device in series for the scope of usage of each operand.
A rising edge contact will be TRUE after power is turned on if the rising edge contact is On before power is turned on to the PLC.

Command	Function					
LDF	Start of reverse edge detection action					
Operand	X0~X17	Y0~Y17	M0~M799	T0~159	C0~C79	D0~D399
	✓	✓	✓	✓	✓	—

Explanation The LDF command has the same usage as LD, but its action is different; its function is to save current content while also saving the detected state of the falling edge of the contact to the cumulative register.

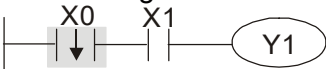
Example Ladder diagram: 

Command code:	Description:
LDF X0	Start of X0 reverse edge detection action
AND X1	Create series connection to contact a of X1
OUT Y1	Drive Y1 coil

Command	Function					
ANDP	Forward edge detection series connection					
Operand	X0~X17	Y0~Y17	M0~M799	T0~159	C0~C79	D0~D399
	✓	✓	✓	✓	✓	—

Explanation The ANDP command used for a contact rising edge detection series connection.

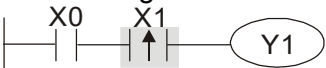
Example Ladder diagram: 

Command code:	Description:
LD X0	Load Contact a of X0
ANDP X1	X1 Forward edge detection series connection
OUT Y1	Drive Y1 coil

Command	Function					
ANDF	Reverse edge detection series connection					
Operand	X0~X17	Y0~Y17	M0~M799	T0~159	C0~C79	D0~D399
	✓	✓	✓	✓	✓	—

Explanation The ANDF command is used for a contact falling edge detection series connection.

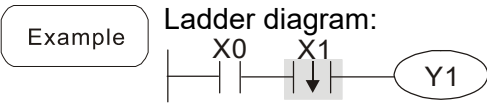

Command code:		Description:
LD	X0	Load Contact a of X0
ANDF	X1	X1 Reverse edge detection series connection
OUT	Y1	Drive Y1 coil

Command	Function					
ORP	Forward edge detection parallel connection					
Operand	X0~X17	Y0~Y17	M0~M799	T0~159	C0~C79	D0~D399
	✓	✓	✓	✓	✓	—

Explanation The ORP command is used for a contact rising edge detection parallel connection.

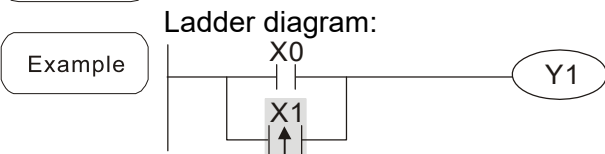

Command code:		Description:
LD	X0	Load Contact a of X0
ORP	X1	X1 Forward edge detection parallel connection
OUT	Y1	Drive Y1 coil

Command	Function					
ORF	Reverse edge detection parallel connection					
Operand	X0~X17	Y0~Y17	M0~M799	T0~159	C0~C79	D0~D399
	✓	✓	✓	✓	✓	—

Explanation The ORF command is used for contact falling edge detection parallel connection.

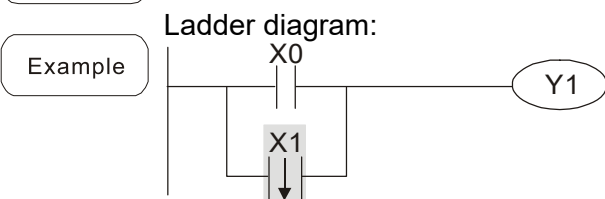

Command code:		Description:
LD	X0	Load Contact a of X0
ORF	X1	X1 Reverse edge detection parallel connection
OUT	Y1	Drive Y1 coil

Command	Function					
PLS	Upper differential output					
Operand	X0~X17	Y0~Y17	M0~M799	T0~159	C0~C79	D0~D399
	—	✓	✓	—	—	—

Explanation

Upper differential output commands. When X0=Off→On (positive edge-triggered), the PLS command will be executed, and M0 will send one pulse, with a pulse length consisting of one scanning period.

Example

Ladder diagram:

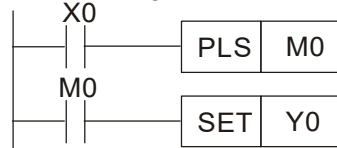

Time sequence diagram:

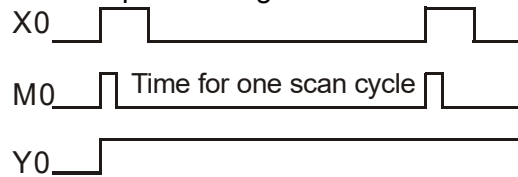

Command code:

Description:

LD	X0	Load Contact a of X0
PLS	M0	M0 Upper differential output
LD	M0	Load Contact a of M0
SET	Y0	Y0 Action continues (ON)

Command	Function					
PLF	Lower differential output					
Operand	X0~X17	Y0~Y17	M0~M799	T0~159	C0~C79	D0~D399
	—	✓	✓	—	—	—

Explanation

Lower differential output command. When X0= On→Off (negative edge-triggered), the PLF command will be executed, and M0 will send one pulse, with pulse length consisting of one scanning period.

Example

Ladder diagram:

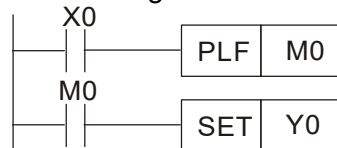

Time sequence diagram:

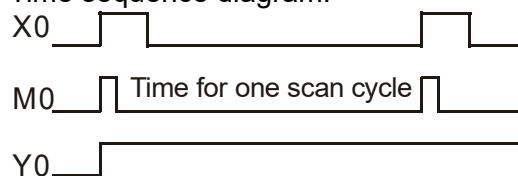

Command code:

Description:

LD	X0	Load Contact a of X0
PLF	M0	M0 Lower differential output
LD	M0	Load Contact a of M0
SET	Y0	Y0 Action continues (ON)

Command	Function
END	Program conclusion
Operand	N/A

Explanation

An END command must be added to the end of a ladder diagram program or command program. The PLC will scan from address 0 to the END command, and will return to address 0 and begins scanning again after execution.

Command	Function
NOP	No action
Operand	N/A

Explanation The command NOP does not perform any operation in the program. Because execution of this command will retain the original logical operation results, it can be used in the following situation: the NOP command can be used instead of a command that is deleted without changing the program length.

Example Ladder diagram: Command code: Description:

NOP command will be simplified and not displayed when the ladder diagram is displayed.

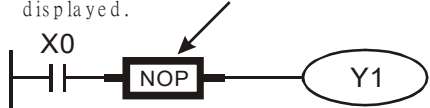

LD	X0	Load Contact b of X0
NOP		No action
OUT	Y1	Drive Y1 coil

Command	Function
INV	Inverse of operation results
Operand	N/A

Explanation Saves the result of the logic inversion operation prior to the INV command in the cumulative register.

Example Ladder diagram: Command code: Description:



LD	X0	Load Contact a of X0
INV		Inverse of operation results
OUT	Y1	Drive Y1 coil

Command	Function
P	Index
Operand	P0~P255

Explanation Pointer P is used to subprogram call command API 01 CALL. Use does not require starting from zero, but the number cannot be used repeatedly, otherwise an unpredictable error will occur.

Example Ladder diagram: Command code: Description:

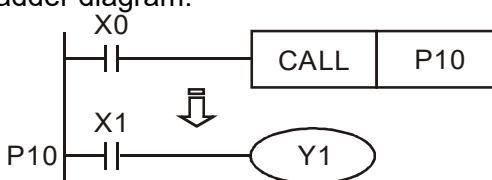

LD	X0	Load Contact a of X0
CALL	P10	Call command CALL to P10
:		
P10		Pointer P10
LD	X1	Load Contact a of X1
OUT	Y1	Drive Y1 coil

16-6-3 Overview of application commands

Classification	API	Command code		P command	Function	STEPS	
		16 bit	32 bit			16bit	32bit
Circuit control	01	CALL	-	✓	Call subprogram	3	-
	02	SRET	-	-	Conclusion of subprogram	1	-
	06	FEND	-	-	Conclusion a main program	1	-
Send comparison	10	CMP	DCMP	✓	Compares set output	7	13
	11	ZCP	DZCP	✓	Range comparison	9	17
	12	MOV	DMOV	✓	Data movement	5	9
	15	BMOV	-	✓	Send all	7	-
Four logical operations	20	ADD	DADD	✓	BIN addition	7	13
	21	SUB	DSUB	✓	BIN subtraction	7	13
	22	MUL	DMUL	✓	BIN multiplication	7	13
	23	DIV	DDIV	✓	BIN division	7	13
	24	INC	DINC	✓	BIN add one	3	5
	25	DEC	DDEC	✓	BIN subtract one	3	5
Rotational displacement	30	ROR	DROR	✓	Right rotation	5	-
	31	ROL	DROL	✓	Left rotation	5	-
Data Process	40	ZRST	-	✓	Clear range	5	-
	49	-	DFLT	✓	BIN whole number → binary floating point number transformation	-	9
Communication	150	MODRW	-	✓	MODBUS read/write	7	-
Floating point operation	110	-	DECMP	✓	Comparison of binary floating point numbers	-	13
	111	-	DEZCP	✓	Comparison of binary floating point number range	-	17
	116	-	DRAD	✓	Angle → Diameter	-	9
	117	-	DDEG	✓	Diameter → angle	-	9
	120	-	DEADD	✓	Binary floating point number addition	-	13
	121	-	DESUB	✓	Binary floating point number subtraction	-	13
	122	-	DEMUL	✓	Binary floating point number multiplication	-	13
	123	-	DEDIV	✓	Binary floating point number division	-	13
	124	-	DEXP	✓	Binary floating point number obtain exponent	-	9
	125	-	DLN	✓	Binary floating point number obtain logarithm	-	9
	127	-	DESQR	✓	Binary floating point number find square root	-	9
	129	-	DINT	✓	Binary floating point number → BIN whole number transformation	-	9
	130	-	DSIN	✓	Binary floating point number SIN operation	-	9
	131	-	DCOS	✓	Binary floating point number COS operation	-	9
	132	-	DTAN	✓	Binary floating point number TAN operation	-	9
	133	-	DASIN	✓	Binary floating point number ASIN operation	-	9
134	-	DACOS	✓	Binary floating point number ACOS operation	-	9	
135	-	DATAN	✓	Binary floating point number ATAN operation	-	9	

Classification	API	Command code		P command	Function	STEPS	
		16 bit	32 bit			16bit	32bit
Floating point operation	136	–	DSINH	✓	Binary floating point number SINH operation	–	9
	137	–	DCOSH	✓	Binary floating point number COSH operation	–	9
	138	–	DTANH	✓	Binary floating point number TANH operation	–	9
Calendar	160	TCMP	–	✓	Compare calendar data	11	–
	161	TZCP	–	✓	Compare calendar data range	9	–
	162	TADD	–	✓	Calendar data addition	7	–
	163	TSUB	–	✓	Calendar data subtraction	7	–
	166	TRD	–	✓	Calendar data read	3	–
GRAY code	170	GRY	DGRY	✓	BIN→GRY code transformation	5	9
	171	GBIN	DGBIN	✓	GRY code →BIN transformation	5	9
Contact form logical operation	215	LD&	DLD&	-	Contact form logical operation LD#	5	9
	216	LD	DLD	-	Contact form logical operation LD#	5	9
	217	LD^	DLD^	-	Contact form logical operation LD#	5	9
	218	AND&	DAND&	-	Contact form logical operation AND#	5	9
	219	ANDI	DANDI	-	Contact form logical operation AND#	5	9
	220	AND^	DAND^	-	Contact form logical operation AND#	5	9
	221	OR&	DOR&	-	Contact form logical operation OR#	5	9
	222	OR	DOR	-	Contact form logical operation OR#	5	9
	223	OR^	DOR^	-	Contact form logical operation OR#	5	9
Contact form compare command	224	LD=	DLD=	-	Contact form compare LD*	5	9
	225	LD>	DLD>	-	Contact form compare LD*	5	9
	226	LD<	DLD<	-	Contact form compare LD*	5	9
	228	LD<>	DLD<>	-	Contact form compare LD*	5	9
	229	LD<=	DLD<=	-	Contact form compare LD*	5	9
	230	LD>=	DLD>=	-	Contact form compare LD*	5	9
	232	AND=	DAND=	-	Contact form compare AND*	5	9
	233	AND>	DAND>	-	Contact form compare AND*	5	9
	234	AND<	DAND<	-	Contact form compare AND*	5	9
	236	AND<>	DAND<>	-	Contact form compare AND*	5	9
	237	AND<=	DAND<=	-	Contact form compare AND*	5	9
	238	AND>=	DAND>=	-	Contact form compare AND*	5	9
	240	OR=	DOR=	-	Contact form compare OR*	5	9
	241	OR>	DOR>	-	Contact form compare OR*	5	9
242	OR<	DOR<	-	Contact form compare OR*	5	9	
244	OR<>	DOR<>	-	Contact form compare OR*	5	9	
245	OR<=	DOR<=	-	Contact form compare OR*	5	9	
246	OR>=	DOR>=	-	Contact form compare OR*	5	9	

Classification	API	Command code		P command	Function	STEPS	
		16 bit	32 bit			16bit	32bit
Floating point contact form	275	-	FLD=	-	Floating point number contact form compare LD*	-	9
	276	-	FLD>	-	Floating point number contact form compare LD*	-	9
	277	-	FLD<	-	Floating point number contact form compare LD*	-	9
Compare command	278	-	FLD<>	-	Floating point number contact form compare LD*	-	9
	279	-	FLD<=	-	Floating point number contact form compare LD*	-	9
	280	-	FLD>=	-	Floating point number contact form compare LD*	-	9
	281	-	FAND=	-	Floating point number contact form compare AND*	-	9
	282	-	FAND>	-	Floating point number contact form compare AND*	-	9
	283	-	FAND<	-	Floating point number contact form compare AND*	-	9
	284	-	FAND<>	-	Floating point number contact form compare AND*	-	9
	285	-	FAND<=	-	Floating point number contact form compare AND*	-	9
	286	-	FAND>=	-	Floating point number contact form compare AND*	-	9
	287	-	FOR=	-	Floating point number contact form compare OR*	-	9
	288	-	FOR>	-	Floating point number contact form compare OR*	-	9
	289	-	FOR<	-	Floating point number contact form compare OR*	-	9
	290	-	FOR<>	-	Floating point number contact form compare OR*	-	9
	291	-	FOR<=	-	Floating point number contact form compare OR*	-	9
	292	-	FOR>=	-	Floating point number contact form compare OR*	-	9
Driver special command	139	RPR	-	✓	Read servo parameter	5	-
	140	WPR	-	✓	Write servo parameter	5	-
	141	FPID	-	✓	Driver PID control mode	9	-
	142	FREQ	-	✓	Driver torque control mode	7	-
	261	CANRX	-	✓	Read CANopen slave station data	9	-
	264	CANTX	-	✓	Write CANopen slave station data	9	-
	265	CANFLS	-	✓	Refresh special D corresponding to CANopen	3	-
	320	ICOMR	DICOMR	✓	Internal communications read	9	17
	321	ICOMW	DICOMW	✓	Internal communications write	9	17

16-6-4 Detailed explanation of applications commands

API 01	CALL	P	(S)	Call subprogram																																															
<table border="1"> <thead> <tr> <th colspan="3">Bit device</th> <th colspan="8">Word device</th> </tr> <tr> <th>X</th><th>Y</th><th>M</th> <th>K</th><th>H</th><th>KnX</th><th>KnY</th><th>KnM</th><th>T</th><th>C</th><th>D</th> </tr> </thead> <tbody> <tr> <td colspan="4">Notes on operand usage: The S operand can designate P C2000 series device: The S operand can designate P0-P63</td> <td colspan="4"> <table border="1"> <thead> <tr> <th colspan="4">16-bit command (3 STEP)</th> </tr> <tr> <td>CALL</td><td>Continuous execution type</td><td>CALLP</td><td>Pulse execution type</td> </tr> </thead> <tbody> <tr> <td colspan="4">32-bit command</td> </tr> <tr> <td>—</td><td>—</td><td>—</td><td>—</td> </tr> </tbody> </table> </td> <td colspan="2">Flag signal: none</td> </tr> </tbody> </table>				Bit device			Word device								X	Y	M	K	H	KnX	KnY	KnM	T	C	D	Notes on operand usage: The S operand can designate P C2000 series device: The S operand can designate P0-P63				<table border="1"> <thead> <tr> <th colspan="4">16-bit command (3 STEP)</th> </tr> <tr> <td>CALL</td><td>Continuous execution type</td><td>CALLP</td><td>Pulse execution type</td> </tr> </thead> <tbody> <tr> <td colspan="4">32-bit command</td> </tr> <tr> <td>—</td><td>—</td><td>—</td><td>—</td> </tr> </tbody> </table>				16-bit command (3 STEP)				CALL	Continuous execution type	CALLP	Pulse execution type	32-bit command				—	—	—	—	Flag signal: none	
Bit device			Word device																																																
X	Y	M	K	H	KnX	KnY	KnM	T	C	D																																									
Notes on operand usage: The S operand can designate P C2000 series device: The S operand can designate P0-P63				<table border="1"> <thead> <tr> <th colspan="4">16-bit command (3 STEP)</th> </tr> <tr> <td>CALL</td><td>Continuous execution type</td><td>CALLP</td><td>Pulse execution type</td> </tr> </thead> <tbody> <tr> <td colspan="4">32-bit command</td> </tr> <tr> <td>—</td><td>—</td><td>—</td><td>—</td> </tr> </tbody> </table>				16-bit command (3 STEP)				CALL	Continuous execution type	CALLP	Pulse execution type	32-bit command				—	—	—	—	Flag signal: none																											
16-bit command (3 STEP)																																																			
CALL	Continuous execution type	CALLP	Pulse execution type																																																
32-bit command																																																			
—	—	—	—																																																

Explanation

- **S** : Call subprogram pointer.
- Write the subprogram after the FEND command.
- The subprogram must end after the SRET command.
- Refer to the FEND command explanation and sample content for detailed command functions.

API 02	SRET	P	—	Conclusion of subprogram																																															
<table border="1"> <thead> <tr> <th colspan="3">Bit device</th> <th colspan="8">Word device</th> </tr> <tr> <th>X</th><th>Y</th><th>M</th> <th>K</th><th>H</th><th>KnX</th><th>KnY</th><th>KnM</th><th>T</th><th>C</th><th>D</th> </tr> </thead> <tbody> <tr> <td colspan="4">Notes on operand usage: No operand A contact-driven command is not needed</td> <td colspan="4"> <table border="1"> <thead> <tr> <th colspan="4">16-bit command (1 STEP)</th> </tr> <tr> <td>FEND</td><td>Continuous execution type</td><td>—</td><td>—</td> </tr> </thead> <tbody> <tr> <td colspan="4">32-bit command</td> </tr> <tr> <td>—</td><td>—</td><td>—</td><td>—</td> </tr> </tbody> </table> </td> <td colspan="2">Flag signal: none</td> </tr> </tbody> </table>				Bit device			Word device								X	Y	M	K	H	KnX	KnY	KnM	T	C	D	Notes on operand usage: No operand A contact-driven command is not needed				<table border="1"> <thead> <tr> <th colspan="4">16-bit command (1 STEP)</th> </tr> <tr> <td>FEND</td><td>Continuous execution type</td><td>—</td><td>—</td> </tr> </thead> <tbody> <tr> <td colspan="4">32-bit command</td> </tr> <tr> <td>—</td><td>—</td><td>—</td><td>—</td> </tr> </tbody> </table>				16-bit command (1 STEP)				FEND	Continuous execution type	—	—	32-bit command				—	—	—	—	Flag signal: none	
Bit device			Word device																																																
X	Y	M	K	H	KnX	KnY	KnM	T	C	D																																									
Notes on operand usage: No operand A contact-driven command is not needed				<table border="1"> <thead> <tr> <th colspan="4">16-bit command (1 STEP)</th> </tr> <tr> <td>FEND</td><td>Continuous execution type</td><td>—</td><td>—</td> </tr> </thead> <tbody> <tr> <td colspan="4">32-bit command</td> </tr> <tr> <td>—</td><td>—</td><td>—</td><td>—</td> </tr> </tbody> </table>				16-bit command (1 STEP)				FEND	Continuous execution type	—	—	32-bit command				—	—	—	—	Flag signal: none																											
16-bit command (1 STEP)																																																			
FEND	Continuous execution type	—	—																																																
32-bit command																																																			
—	—	—	—																																																

Explanation

- A contact-driven command is not needed. Automatically returns next command after CALL command
- Indicates end of subprogram. After end of subprogram, SRET returns to main program, and executes next command after the original call subprogram CALL command.
- Refer to the FEND command explanation and sample content for detailed command functions.

API 06	FEND	—	Conclusion a main program
-----------	-------------	---	---------------------------

	Bit device			Word device							16-bit command (1 STEP)				
	X	Y	M	K	H	KnX	KnY	KnM	T	C	D	FEND	Continuous execution type	—	—
Notes on operand usage: No operand A contact-driven command is not needed												32-bit command			
												— — — —			
												Flag signal: none			

Explanation

- This command indicates the end of the main program. It is the same as the END command when the PLC executes this command.
- The CALL command program must be written after the FEND command, and the SRET command added to the end of the subprogram.
- When using the FEND command, an END command is also needed. However, the END command must be placed at the end, after the main program and subprogram.

CALL command process

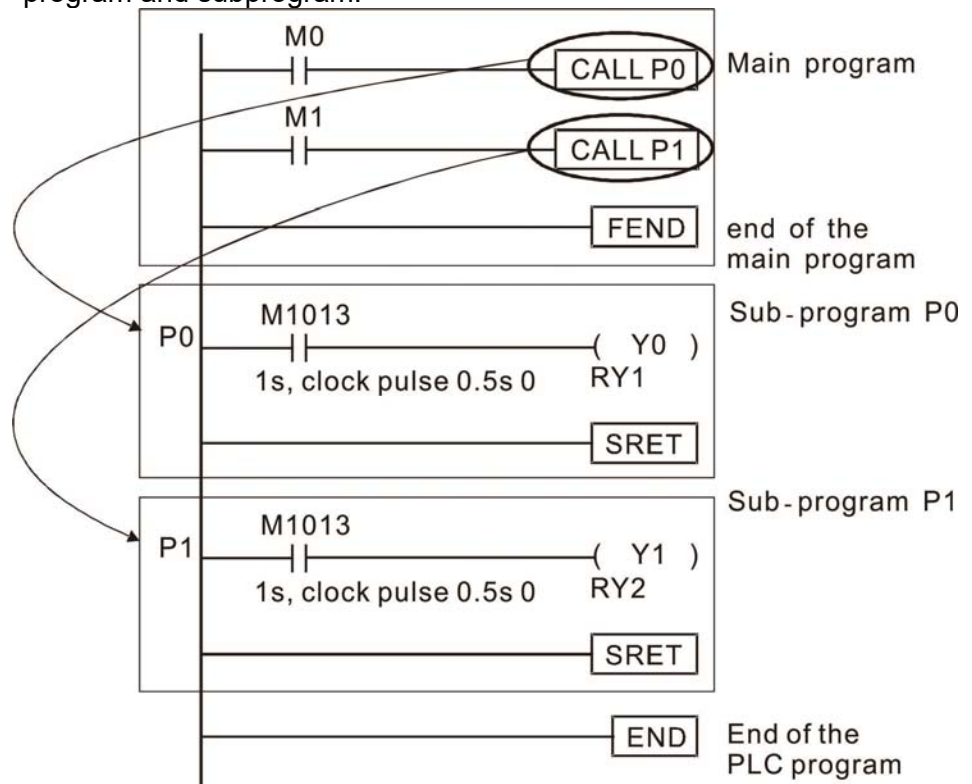

API 10	D	CMP	P	(S1)	(S2)	(D)	Compares set output							
Bit device			Word device								16-bit command (7 STEP)			
X	Y	M	K	H	KnX	KnY	KnM	T	C	D	CMP	Continuous execution type	CMPP	Pulse execution type
S1			*	*	*	*	*	*	*	*				
S2			*	*	*	*	*	*	*	*				
D		*	*											
Notes on operand usage: The operand D occupies three consecutive points											32-bit command (13 STEP)			
											DCMP	Continuous execution type	DCMPP	Pulse execution type
											Flag signal: none			

- Explanation**
- (S1): Compare value 1. (S2): Compare value 2. (D): Results of comparison.
 - Compares the size of the content of operand (S1) and (S2); the results of comparison are expressed in (D).
 - Size comparison is performed algebraically. All data is compared in the form of numerical binary values. Because this is a 16-bit command, when b15 is 1, this indicates a negative number.

- Example**
- When the designated device is Y0, it automatically occupies Y0, Y1 and Y2.
 - When X10=On, the CMP command executes, and Y0, Y1 or Y2 will be On. When X10=Off, the CMP command will not execute, and the state of Y0, Y1 and Y2 will remain in the state prior to X10=Off.
 - If \geq , \leq , or \neq results are needed, they can be obtained via series/parallel connections of Y0-Y2.

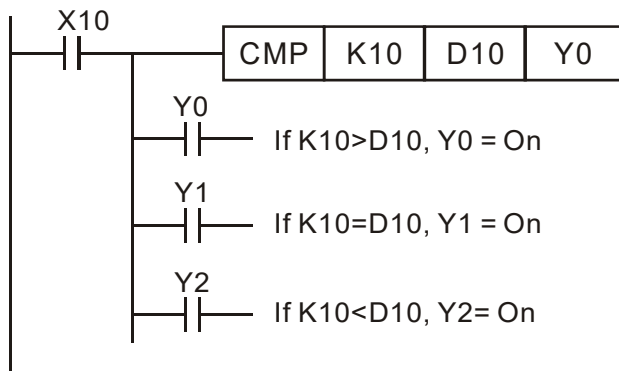

- To clear results of comparison, use the RST or ZRST command.

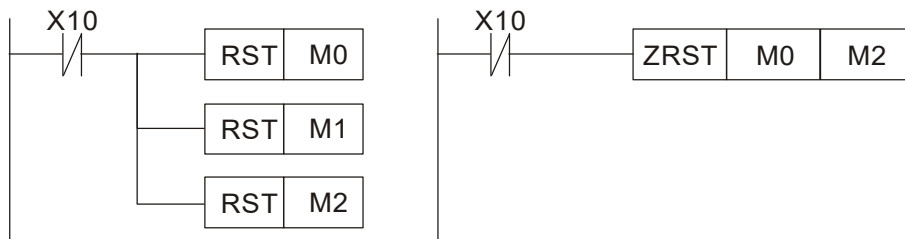

API 11	D	ZCP	P	(S1)	(S2)	(S)	(D)	Range comparison										
Bit device			Word device								16-bit command (9 STEP)							
X	Y	M	K	H	KnX	KnY	KnM	T	C	D	ZCP	Continuous execution type	ZCPP	Pulse execution type				
S1			*	*	*	*	*	*	*	*								
S2			*	*	*	*	*	*	*	*								
S			*	*	*	*	*	*	*	*								
D		*	*															
Notes on operand usage: The content value of operand S1 is less than the content value of S2 operand The operand D occupies three consecutive points											32-bit command (17 STEP)							
											DZCP				Continuous execution type	DZCPP	Pulse execution type	
															Flag signal: none			

Explanation

- (S1): Lower limit of range comparison. (S2): Upper limit of range comparison. (S): Comparative value. (D): Results of comparison.
- When the comparative value (S) is compared with the lower limit (S1) and upper limit (S2), the results of comparison are expressed in (D).
- When lower limit (S1) > upper limit (S2), the command will use the lower limit (S1) to perform comparison with the upper and lower limit.
- Size comparison is performed algebraically. All data is compared in the form of numerical binary values. Because this is a 16-bit command, when b15 is 1, this indicates a negative number.

Example

- When the designated device is M0, it automatically occupies M0, M1 and M2.
- When X0=On, the ZCP command executes, and M0, M1 or M2 will be On. When X0=Off, the ZCP command will not execute, and the state of M0, M1 or M2 will remain in the state prior to X0=Off.
- If ≥, ≤, or ≠ results are needed, they can be obtained via series/parallel connections of M0-M2.

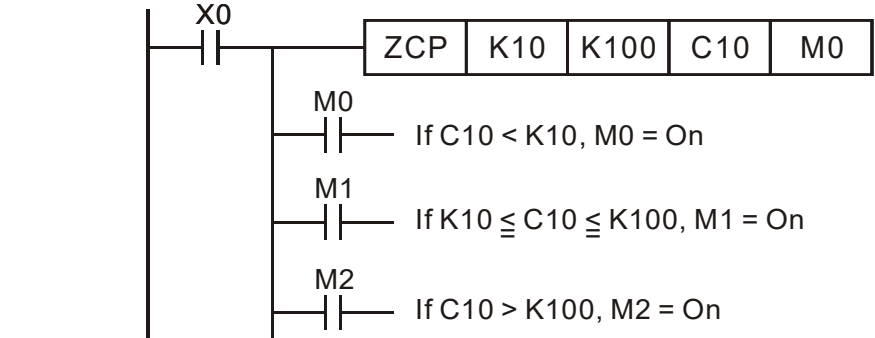

- To clear results of comparison, use the RST or ZRST command.

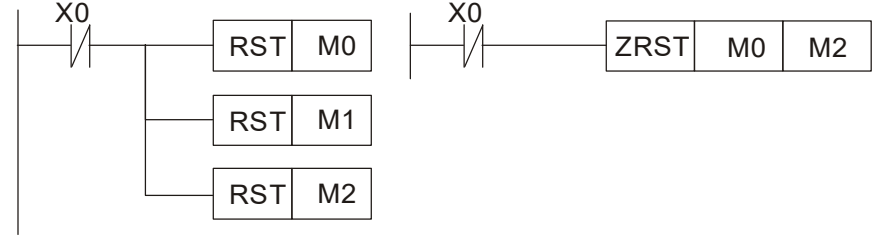

API 12	D	MOV	P	(S) (D)	Data movement									
Bit device		Word device									16-bit command (5 STEP)			
X	Y	M	K	H	KnX	KnY	KnM	T	C	D	MOV	Continuous execution type	MOVP	Pulse execution type
S			*	*	*	*	*	*	*	*				
D						*	*	*	*	*				
Notes on operand usage: none											32-bit command (9 STEP)			
											DMOV	Continuous execution type	DMOVP	Pulse execution type
Flag signal:														

- Explanation**
- (S): Data source. (D): Destination of data movement.
 - When this command is executed, the content of (S) content will be directly moved to (D). When the command is not executed, the content of (D) will not change.
- Example**
- When X0=Off, the content of D10 will not change; if X0=On, the value K10 will be sent to data register D10.
 - When X1=Off, the content of D10 will not change; if X1=On, the current value of T0 will be sent to data register D10.

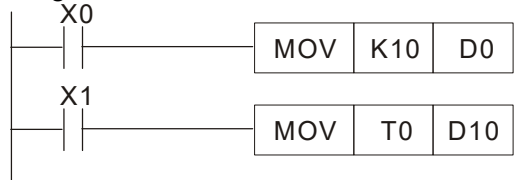

API 15	BMOV		P	(S) (D) (n)	Send all																																																															
<table border="1"> <thead> <tr> <th colspan="3">Bit device</th> <th colspan="8">Word device</th> </tr> <tr> <th>X</th> <th>Y</th> <th>M</th> <th>K</th> <th>H</th> <th>KnX</th> <th>KnY</th> <th>KnM</th> <th>T</th> <th>C</th> <th>D</th> </tr> </thead> <tbody> <tr> <td>S</td> <td></td> <td></td> <td></td> <td></td> <td>*</td> <td>*</td> <td>*</td> <td>*</td> <td>*</td> <td>*</td> </tr> <tr> <td>D</td> <td></td> <td></td> <td></td> <td></td> <td></td> <td>*</td> <td>*</td> <td>*</td> <td>*</td> <td>*</td> </tr> <tr> <td>n</td> <td></td> <td></td> <td>*</td> <td>*</td> <td></td> <td></td> <td></td> <td>*</td> <td>*</td> <td></td> </tr> </tbody> </table>				Bit device			Word device								X	Y	M	K	H	KnX	KnY	KnM	T	C	D	S					*	*	*	*	*	*	D						*	*	*	*	*	n			*	*				*	*		<table border="1"> <thead> <tr> <th colspan="4">16-bit command (7 STEP)</th> </tr> </thead> <tbody> <tr> <td>BMOV</td> <td>Continuous execution type</td> <td>BMOV P</td> <td>Pulse execution type</td> </tr> </tbody> </table>		16-bit command (7 STEP)				BMOV	Continuous execution type	BMOV P	Pulse execution type
Bit device			Word device																																																																	
X	Y	M	K	H	KnX	KnY	KnM	T	C	D																																																										
S					*	*	*	*	*	*																																																										
D						*	*	*	*	*																																																										
n			*	*				*	*																																																											
16-bit command (7 STEP)																																																																				
BMOV	Continuous execution type	BMOV P	Pulse execution type																																																																	
Notes on operand usage: n operand scope n = 1 to 512				32-bit command																																																																
				Flag signal: none																																																																

- Explanation**
- (S): Initiate source device. (D): Initiate destination device. (n): Send block length.
 - The content of n registers starting from the initial number of the device designated by (S) will be sent to the n registers starting from the initial number of the device designated by (D); if the number of points referred to by n exceeds the range used by that device, only points within the valid range will be sent.

- Example 1**
- When X10=On, the content of registers D0-D3 will be sent to the four registers D20 to D23.



- Example 2**
- If the designated bit devices KnX, KnY, and KnM are sent, (S) and (D) must have the same number of nibbles, which implies that n must be identical.

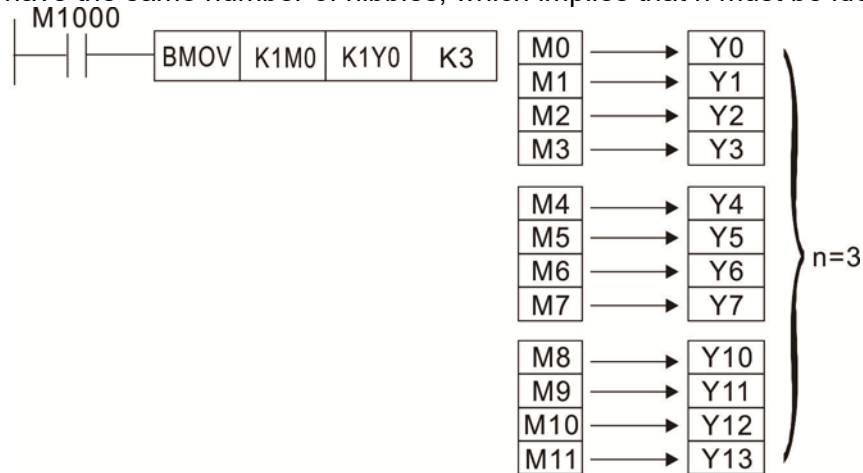

- Example 3**
- In order to prevent overlap between the transmission addresses of two operands, which would cause confusion, make sure that the addresses designated by the two operands have different sizes, as shown below:

When (S) > (D), send in the order ① → ② → ③.

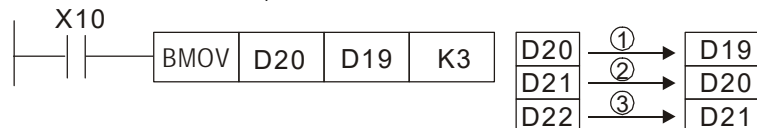

When (S) < (D), send in the order ③ → ② → ①.

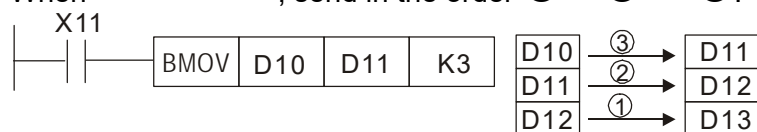

API 20	D	ADD	P	(S1)	(S2)	(D)	BIN addition							
Bit device			Word device								16-bit command (7 STEP)			
X	Y	M	K	H	KnX	KnY	KnM	T	C	D	ADD	Continuous execution type	ADDP	Pulse execution type
S1			*	*	*	*	*	*	*	*				
S2			*	*	*	*	*	*	*	*				
D						*	*	*	*	*	32-bit command (13 STEP)			
Notes on operand usage: none											DADD	Continuous execution type	DADDP	Pulse execution type
											Flag signal: M1020 Zero flag M1021 Borrow flag M1022 Carry flag Please refer to the following supplementary explanation			

- Explanation**
- (S1): Augend. (S2): Addend. (D): Sum.
 - Using two data sources: The result of adding (S1) and (S2) using the BIN method will be stored in (D).
 - The highest bit of any data is symbolized as bit 0 indicating (positive) 1 indicating (negative), enabling the use of algebraic addition operations. (for instance: 3+(-9)=-6)
 - Flag changes connected with the addition.
 1. When calculation results are 0, the zero flag M1020 will be On.
 2. When calculation results are less than -32,768, the borrow flag M1021 will be On.
 3. When calculation results are greater than 32,767, the carry flag M1022 will be On.

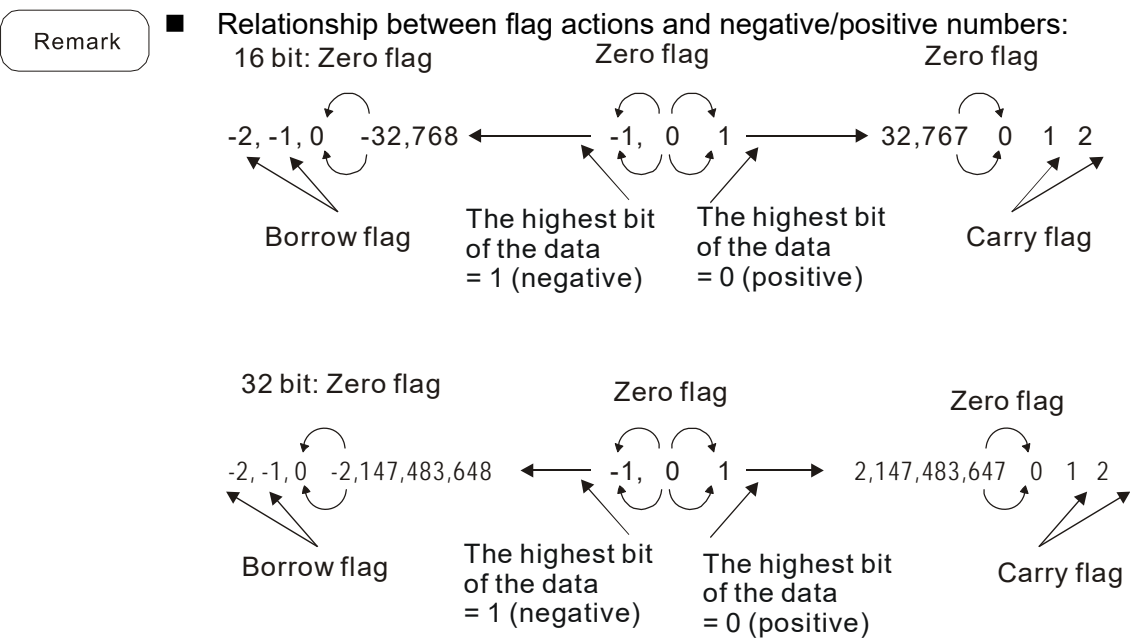
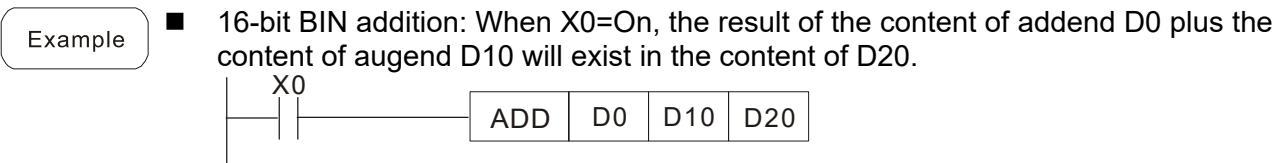

API 21	D	SUB	P	(S1)	(S2)	(D)	BIN subtraction								
Bit device			Word device								16-bit command (7 STEP)				
	X	Y	M	K	H	KnX	KnY	KnM	T	C	D	SUB	Continuous execution type	SUBP	Pulse execution type
S1				*	*	*	*	*	*	*	*				
S2				*	*	*	*	*	*	*	*				
D							*	*	*	*	*				
Notes on operand usage: none												32-bit command (13 STEP)			
												DSUB	Continuous execution type	DSUBP	Pulse execution type
												Flag signal: M1020 Zero flag M1021 Borrow flag M1022 Carry flag Please refer to the following supplementary explanation			

Explanation

- (S1): Minuend. (S2): Subtrahend. (D): Difference.
- Using two data sources: The result of subtraction of (S1) and (S2) using the BIN method is stored in (D).
- The highest bit of any data is symbolized as bit 0 indicating (positive) 1 indicating (negative), enabling the use of algebraic subtraction operations.
- Flag changes connected with subtraction.
 1. When calculation results are 0, the zero flag M1020 will be On.
 2. When calculation results are less than -32,768, the borrow flag M1021 will be On.
 3. When calculation results are greater than 32,767, the carry flag M1022 will be On.

Example

- 16-bit BIN subtraction: When X0=On, the content of D0 is subtracted from the content of D10, and the difference is stored in D20.



API 22	D	MUL	P	(S1)	(S2)	(D)	BIN multiplication							
Bit device			Word device								16-bit command (7 STEP)			
X	Y	M	K	H	KnX	KnY	KnM	T	C	D	MUL	Continuous execution type	MULP	Pulse execution type
S1			*	*	*	*	*	*	*	*				
S2			*	*	*	*	*	*	*	*				
D						*	*	*	*	*				
Notes on operand usage: The 16-bit command operand D will occupy 2 consecutive points											32-bit command (13 STEP)			
											DMUL	Continuous execution type	DMULP	Pulse execution type
											Flag signal: none			

- Explanation**
- (S1): Multiplicand. (S2): Multiplier. (D): Product.
 - Using two data sources: When (S1) and (S2) are multiplied using the BIN method, the product is stored in (D).

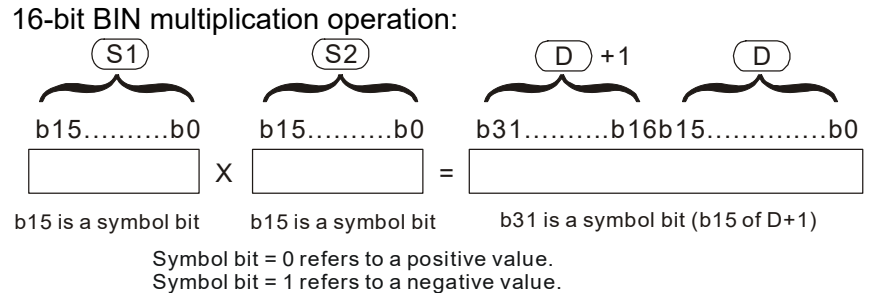

When (D) is a bit device, K1~K4 can be designated as a hexadecimal number, which will occupy 2 consecutive units.

- Example**
- When 16-bit D0 is multiplied by 16-bit D10, the result will be a 32-bit product; the upper 16 bits will be stored in D21, and the lower 16 bits will be stored in D20. Whether the bit at the farthest left is Off or On will indicate the sign of the result.

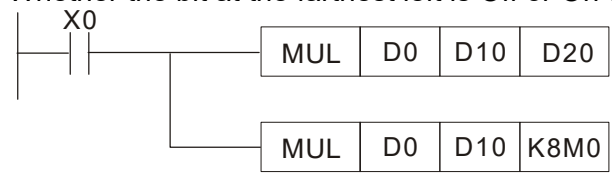

API 23	D	DIV	P	(S1)	(S2)	(D)	BIN division								
Bit device			Word device									16-bit command (7 STEP)			
X	Y	M	K	H	KnX	KnY	KnM	T	C	D	DIV	Continuous execution type	DIVP	Pulse execution type	
S1			*	*	*	*	*	*	*	*					
S2			*	*	*	*	*	*	*	*					
D						*	*	*	*	*	32-bit command (13 STEP)				
											DDIV	Continuous execution type	DDIVP	Pulse execution type	
Notes on operand usage: The 16-bit command operand D will occupy 2 consecutive points											Flag signal: none				

Explanation

- (S1): Dividend. (S2): Divisor. (D): Quotient and remainder.
- Using two data sources: The quotient and remainder will be stored in (D) when (S1) and (S2) are subjected to division using the BIN method. The sign bit for (S1), (S2) and (D) must be kept in mind when performing a 16-bit operation.

16-bit BIN division:

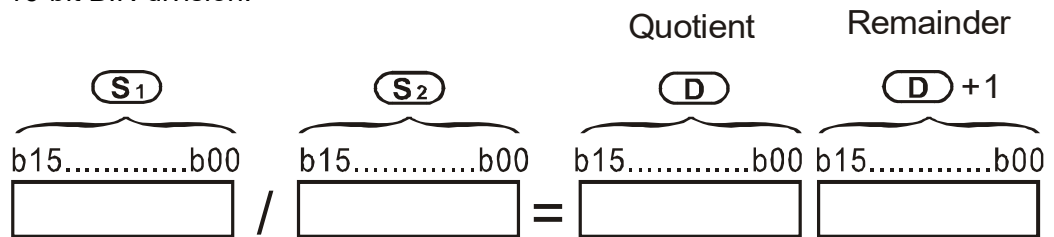

If (D) is a bit device, K1~K4 can be designated 16 bits, which will occupy 2 consecutive units and yield the quotient and remainder.

Example

- When X0=On, the quotient resulting from division of dividend D0 by divisor D10 will be placed in D20, and the remainder will be placed in D21. Whether the highest bit is Off or On will indicate the sign of the result.

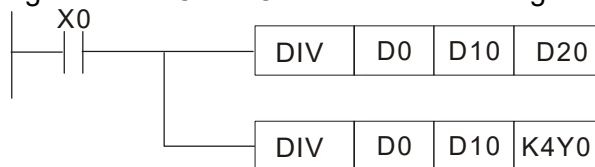

API 24	D	INC	P	(D)	BIN add one										
Bit device		Word device										16-bit command (3 STEP)			
X	Y	M	K	H	KnX	KnY	KnM	T	C	D	INC	Continuous execution type	INCP	Pulse execution type	
D						*	*	*	*	*	32-bit command (5 STEP)				
Notes on operand usage: none											DINC	Continuous execution type	DINCP	Pulse execution type	
											Flag signal: none				

Explanation

- (D): Destination device.
- If a command is not the pulse execution type, when the command is executed, the program will add 1 to the content of device (D) for each scanning cycle.
- This command is ordinarily used as a pulse execution type command (INCP).
- During 16-bit operation, 32,767 +1 will change the value to -32,768. During 32-bit operation, 2,147,483,647 +1 will change the value to -2,147,483,648.

Example

- When X0=Off→On, 1 is automatically added to the content of D0.

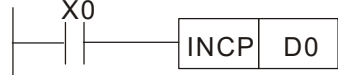

API 25	D	DEC	P	(D)	BIN subtract one									
Bit device			Word device								16-bit command (3 STEP)			
X	Y	M	K	H	KnX	KnY	KnM	T	C	D	DEC	Continuous execution type	DECP	Pulse execution type
D			*	*	*	*	*							
Notes on operand usage: none											32-bit command (5 STEP)			
											DDEC	Continuous execution type	DDECP	Pulse execution type
											Flag signal: none			

Explanation

- (D): Destination device.
- If a command is not the pulse execution type, when the command is executed, the program will add 1 to the content of device (D) for each scanning cycle.
- This command is ordinarily used as a pulse execution type command (DECP).
- During 16-bit operation, -32,768 -1 will change the value to 32,767. During 32 bit operation, -2,147,483,648 -1 will change the value to -2,147,483,647.

Example

- When X0=Off→On, 1 is automatically subtracted from the content of D0.



API 30	D	ROR	P	(D)	(n)	Right rotation									
Bit device		Word device										16-bit command (5 STEP)			
X	Y	M	K	H	KnX	KnY	KnM	T	C	D	ROR	Continuous execution type	RORP	Pulse execution type	
D						*	*	*	*	*					
n			*	*							32-bit command (9 STEP)				
Notes on operand usage: Only K4 (16-bit) will be valid if the operand D is designated as KnY or KnM. n operand n=K1-K16 (16-bit)											DROR	Continuous execution type	DRORP	Pulse execution type	
											Flag signal: M1022 Carry flag				

- Explanation**
- (D): Device to be rotated. (n): Number of bits for one rotation.
 - Rotates the device designated by (D) to the right (n) bits.
 - This command is ordinarily used as a pulse execution type command (RORP).

- Example**
- When X0=Off→On, 4 of the 16 bits in D10 specify a right rotation; the content of the bit indicated with * (see figure below) will be sent to the carry flag signal M1022.

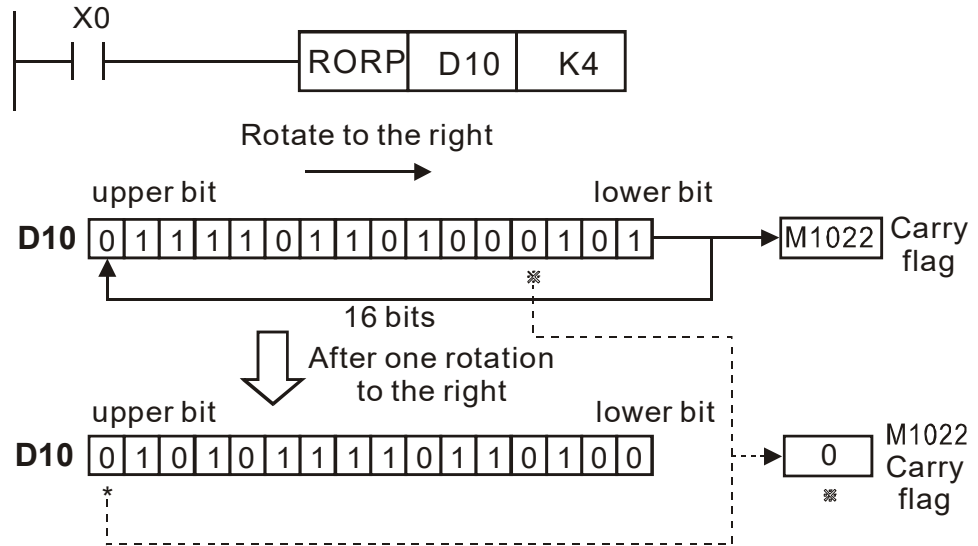

API 31	D	ROL	P	(D)	(n)	Left rotation									
Bit device		Word device										16-bit command (5 STEP)			
X	Y	M	K	H	KnX	KnY	KnM	T	C	D	ROL	Continuous execution type	ROLP	Pulse execution type	
D						*	*	*	*	*					
n			*	*							32-bit command (9 STEP)				
Notes on operand usage: Only K4 (16-bit) will be valid if the operand D is designated as KnY or KnM. n operand n=1 to 16 (16-bit)											DROL	Continuous execution type	DROLP	Pulse execution type	
											Flag signal: M1022 Carry flag				

Explanation

- (D): Device to be rotated. (n): Number of bits for one rotation.
- Rotates the device designated by (D) to the left (n) bits.
- This command is ordinarily used as a pulse execution type command (ROLP).

Example

- When X0=Off→On, 4 of the 16 bits in D10 specify a left rotation; the content of the bit indicated with * (see figure below) will be sent to the carry flag signal M1022.

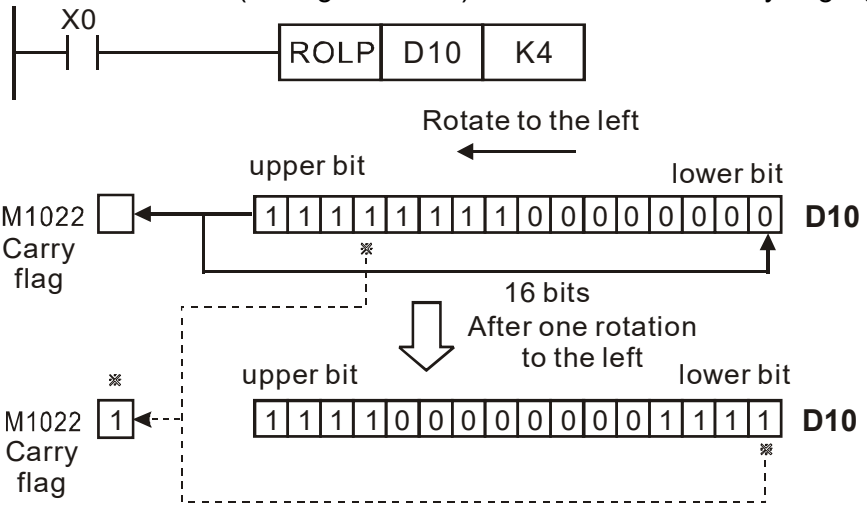

API 40	ZRST	P	(D1) (D2)	Clear range
-----------	------	---	-----------	-------------

	Bit device			Word device								16-bit command (5 STEP)			
	X	Y	M	K	H	KnX	KnY	KnM	T	C	D	ZRST	Continuous execution type	ZRSTP	Pulse execution type
D1	*	*	*						*	*	*				
D2	*	*	*						*	*	*				

Notes on operand usage:
 Number of operand D₁ operand ≤ number of operand D₂
 Operands D₁, D₂ must designate the same type of device
 Please refer to the function specifications table for each device in series for the scope of device usage

32-bit command
 — — — —
 Flag signal: none

Explanation

- D₁: Clear range's initial device. D₂: Clear range's final device.
- When the number of operand D₁ > number of operand D₂, only the operand designated by D₂ will be cleared.

Example

- When X0 is On, auxiliary relays M300 - M399 will be cleared and changed to Off.
- When X1 is On, 16-bit counters C0 - C127 will all be cleared. (Writes 0, and clears and changes contact and coil to Off).
- When X10 is On, timer T0 - T127 will all be cleared. (Writes 0, and clears and changes contact and coil to Off).
- When X3 is On, the data in data registers D0 - D100 will be cleared and set as 0.

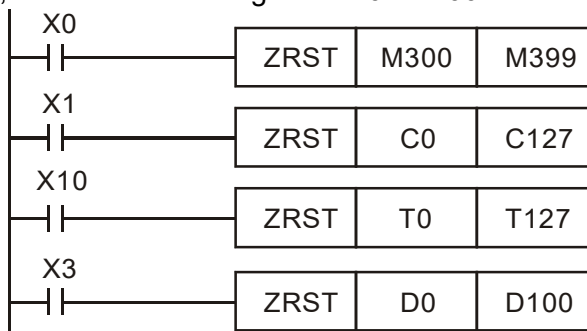

Remark

- Devices can independently use the clear command (RST), such as bit device Y, M and word device T, C, D.

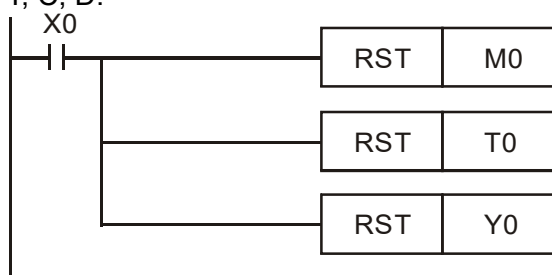

API 49	D	FLT	P	(S)	(D)	BIN whole number → binary decimal transformation									
	Bit device			Word device								16-bit command			
	X	Y	M	K	H	KnX	KnY	KnM	T	C	D	- - - -			
S		*	*						*	*	*	32-bit command (9steps)			
D		*	*						*	*	*	DFLT Continuous DFLTP Pulse execution type execution type			
Notes on operand usage: Please refer to the function specifications table for each device in series for the scope of device usage The operand D will occupy 2 consecutive points												Flag signal: none			

- Explanation
- **S**: Transformation source device. **D**: Device storing transformation results.
 - Transforms BIN whole number into a binary decimal value.

- Example
- When X11 is On, converts the whole number of values corresponding to D0 and D1 into floating point numbers, which are placed in D20 and D21.

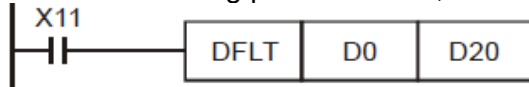

API 150	MODRW	P	(S₁)	(S₂)	(S₃)	(S)	(n)	MODBUS data read/write							
	Bit device			Word device							16-bit command (5 STEP)				
	X	Y	M	K	H	KnX	KnY	KnM	T	C	D	MODRW:	Continuous execution type	MODRW:	Pulse execution type
S1				*	*						*				
S2				*	*						*				
S3				*	*						*				
S											*				
n				*	*						*				
												32-bit command			
												Flag signal: M1077 M1078 M1079			

Explanation

- S1: online device address. S2: communications function code. S3: address of data to read/write. S: register for data to be read/written is stored. N: length of data to be read/written.
- COM1 must be defined as controlled by the PLC (set P9-31 = -12) before using this command, and the corresponding communications speed and format must also be set (set P09-01 and P09-04). S2: communications function code. Currently only supports the following function code; the remaining function code cannot be executed.

Function	Description
H 02	Input read
H 03	Read word
H 06	Write single word
H 0F	Write multiple coils
H10	Write single word

- After executing this command, M1077, M1078 and M1079 will be immediately changed to 0.
- As an example, when C2000 must control another converter and PLC, if the converter has a station number of 10 and the PLC has a station number of 20, see the following example:

Control slave device converter

Serial No.	Example	MODRW command				
		S1	S2	S3	S4	n
		Node ID	Function code	Addresses	Register	Length:
1	Reads 4 sets of data comprising the converter slave device parameters P01-00 to P01-03, and saves the read data in D0 to D3	K10	H3	H100	D0	K4
2	Reads 3 sets of data comprising the converter slave device addresses H2100 to H2102, and saves the read data in D5 to D7	K10	H3	H2100	D5	K3
3	Reads 3 sets of data comprising the converter slave device parameters P05-00 to P05-03, and writes the values as D10 to D12	K10	H10	H500	D10	K3
4	Writes 2 sets of data comprising the converter slave device addresses H2000 to H2001, and writes the values as D15 to D16	K10	H10	H2000	D15	K2

PLC controlling slave device

Serial No.	Example	MODRW command				
		S1	S2	S3	S4	n
		Node ID	Function code	Addresses	Register	Length:
1	Reads 4 sets of data comprising the PLC slave device's X0 to X3 state, and saves the read data in bits 0 to 3 of D0	K20	H2	H400	D0	K4
2	Reads 4 sets of data comprising the PLC slave device's Y0 to Y3 state, and saves the read data in bits 0 to 3 of D1	K20	H2	H500	D1	K4
3	Reads 4 sets of data comprising the PLC slave device's M0 to M3 state, and saves the read data in bits 0 to 3 of D2	K20	H2	H800	D2	K4
4	Reads 4 sets of data comprising the PLC slave device's T0 to T3 state, and saves the read data in bits 0 to 3 of D3	K20	H2	H600	D3	K4
5	Reads 4 sets of data comprising the PLC slave device's C0 to C3 state, and saves the read data in bits 0 to 3 of D4	K20	H2	HE00	D4	K4
6	Reads 4 sets of data comprising the PLC slave device's T0 to T3 count value, and saves the read data of D10 to D13	K20	H3	H600	D10	K4
7	Reads 4 sets of data comprising the PLC slave device's C0 to C3 count value, and saves the read data of D20 to D23	K20	H3	HE00	D20	K4
8	Reads 4 sets of data comprising the PLC slave device's D0 to D3 count value, and saves the read data of D30 to D33	K20	H3	H1000	D30	K4
9	Writes 4 sets of the PLC slave device's Y0 to Y3 state, and writes the values as bits 0 to 3 of D1	K20	HF	H500	D1	K4
10	Writes 4 sets of the PLC slave device's M0 to M3 state, and writes the values as bits 0 to 3 of D2	K20	HF	H800	D2	K4
11	Writes 4 sets of the PLC slave device's T0 to T3 state, and writes the values as bits 0 to 3 of D3	K20	HF	H600	D3	K4
12	Writes 4 sets of the PLC slave device's C0 to C3 state, and writes the values as bits 0 to 3 of D4	K20	HF	HE00	D4	K4
13	Writes 4 sets of the PLC slave device's T0 to T3 state, and writes the values of D10 to D13	K20	H10	H600	D10	K4
14	Writes 4 sets of the PLC slave device's C0 to C3 state, and writes the values of D20 to D23	K20	H10	HE00	D20	K4
15	Writes 4 sets of the PLC slave device's D0 to D3 state, and writes the values of D30 to D33	K20	H10	H1000	D30	K4

Example

- Will trigger M0 On when the PLC begins to operate, and sends instruction to execute one MODRW command.
- After receiving the slave device's response, if the command is correct, it will execute one ROL command, which will cause M1 to be On.
- After receiving the slave device's response, will trigger M50 = 1 after a delay of 10 PLC scanning cycles, and then execute one MODRW command.
- After again receiving the slave device's response, if the command is correct, it will execute one ROL command, and M2 will change to On at this time (and M2 can be defined as a repeat of M); K4M0 will change to K1, and only M0 will remain 1. Transmission can proceed in a continuous cycle. If you wish to add a command, merely add the desired command in the empty frame, and change repeat M to Mn+1.

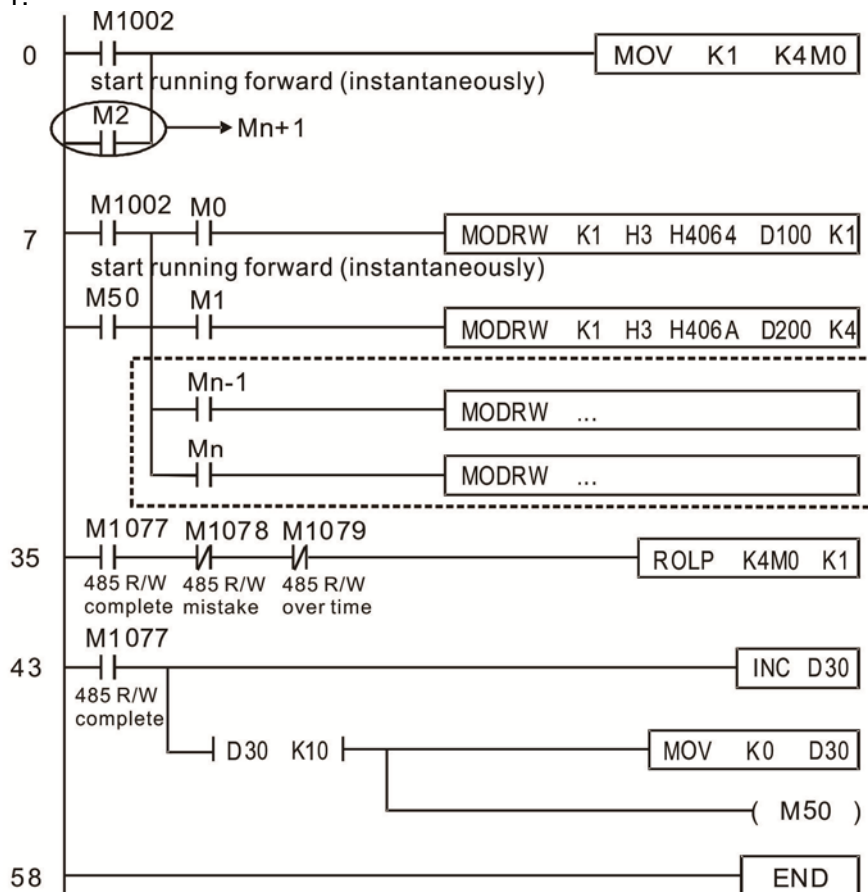

API 110	D	ECMP	P	(S1)	(S2)	(D)	Comparison of binary floating point numbers						
	Bit device			Word device								:16-bit command	
	X	Y	M	K	H	KnX	KnY	KnM	T	C	D	:-----:-----:-----:-----	
S1				*	*						*	:-----:-----:-----:-----	
S2				*	*						*	:32-bit command (13 STEP)	
D				*	*						*	DECMP : Continuous : DECMPP : Pulse execution type : execution type	
Notes on operand usage: The operand D occupies three consecutive points Please refer to the function specifications table for each device in series for the scope of device usage												Flag signal: none	

Explanation

- **S₁**: Comparison of binary floating point numbers value 1. **S₂**: Comparison of binary floating point numbers value 2. **D**: Results of comparison, occupies 3 consecutive points.
- When binary floating point number 1 is compared with comparative binary floating point number 2, the result of comparison (>, =, <) will be expressed in **D**.
- **If the source operand S₁ or S₂ designates a constant K or H, the command will transform the constant to a binary floating-point number for the purpose of comparison.**

Example

- When the designated device is M10, it will automatically occupy M10-M12.
- When X0=On, the DECMP command executes, and one of M10-M12 will be On. When X0=Off, the DECMP command will not execute, and M10-M12 will remain in the X0=Off state.
- If results in the form of ≥, ≤, or ≠ are needed, they can be obtained by series and parallel connection of M10-M12.
- Please use the RST or ZRST command to clear the result.

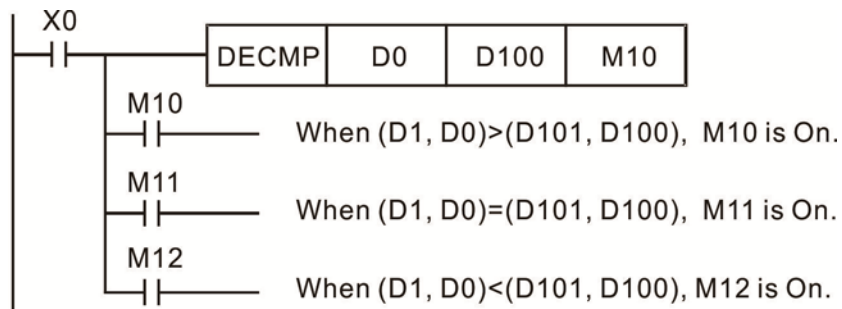

API 111	D	EZCP	P	(S ₁) (S ₂) (S) (D)	Comparison of binary floating point number range
------------	---	------	---	---	--

	Bit device			Word device								16-bit command	
	X	Y	M	K	H	KnX	KnY	KnM	T	C	D		
S1				*	*							*	
S2				*	*							*	
S				*	*							*	
D		*	*										

Notes on operand usage:
The operand D occupies three consecutive points
Please refer to the function specifications table for each device in series for the scope of device usage

32-bit command (17 STEP)
DEZCP : Continuous execution type DEZCPP : Pulse execution type

Flag signal: none

- Explanation**
- **S₁**: Lower limit of binary floating point number in range comparison. **S₂**: Upper limit of binary floating point number in range comparison. **S**: Comparison of binary floating point numerical values. **D**: Results of comparison, occupies 3 consecutive points.
 - Comparison of binary floating point numerical value **S** with binary floating point number lower limit value **S₁** and binary floating point number upper limit value **S₂**; the results of comparison are expressed in **D**.
 - **If the source operand S₁ or S₂ designates a constant K or H, the command will transform the constant to a binary floating-point number for the purpose of comparison.**
 - When the lower limit binary floating point number **S₁** is greater than the upper limit binary floating point number **S₂**, a command will be issued to perform comparison with the upper and lower limits using the binary floating point number lower limit value **S₁**.

- Example**
- When the designated device is M0, it will automatically occupy M0- M2.
 - When X0=On, the DEZCP command will be executed, and one of M0-M2 will be On. When X0=Off, the EZCP command will not execute, and M0-M2 will continue in the X0=Off state.
 - Please use the RST or ZRST command to clear the result.

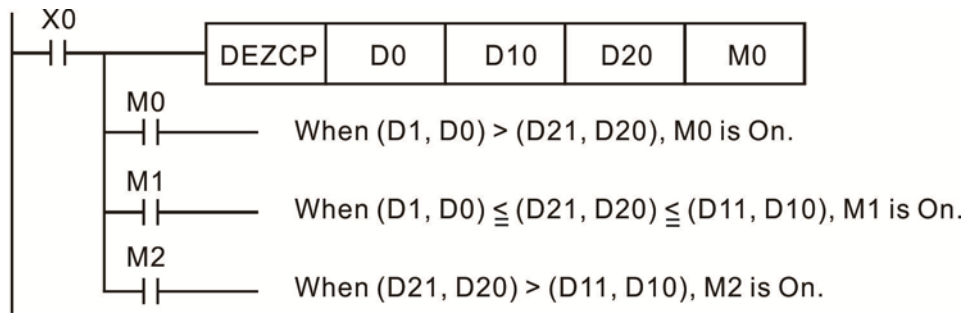

API 116	D	RAD	P	(S) (D)	Angle → Diameter									
Bit device			Word device								16-bit command			
X	Y	M	K	H	KnX	KnY	KnM	T	C	D	-	-	-	-
S			*	*						*	32-bit command (9 STEP)			
D										*	DRAD	Continuous	DRADP	脈波執行型
Notes on operand usage: Please refer to the function specifications table for each device in series for the scope of device usage											Flag signal: none			

Explanation

- **S**: data source (angle). **D**: result of transformation (diameter).
- Uses the following formula to convert angles to radians.
- $\text{Diameter} = \text{Angle} \times (\pi/180)$

Example

- When X0=On, the angle of the designated binary floating point number (D1, D0) will be converted to radians and stored in (D11, D10), with the content consisting of a binary floating point number.

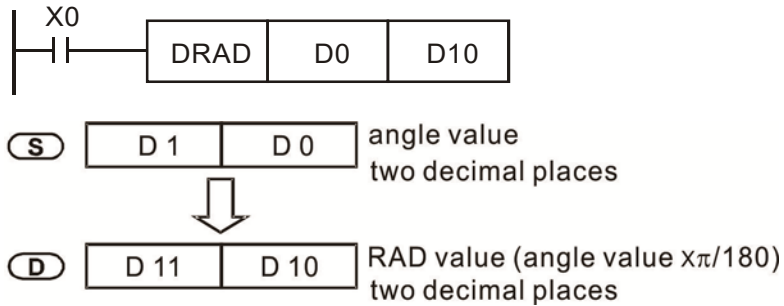

API 117	D	DEG	P	(S) (D)	Diameter → angle									
Bit device			Word device								16-bit command			
X	Y	M	K	H	KnX	KnY	KnM	T	C	D	-	-	-	-
S			*	*						*	32-bit command (9 STEP)			
D										*	DDEG	Continuous execution type	DDEGP	Pulse execution type
Notes on operand usage: Please refer to the function specifications table for each device in series for the scope of device usage											Flag signal: none			

- Explanation
- **S**: data source (diameter). **D**: results of transformation (angle).
 - Uses the following formula to convert radians to an angle.
 - $Angle = Diameter \times (180/\pi)$

- Example
- When X0=On, angle of the designated binary floating point number (D1, D0) in radians will be converted to an angle and stored in (D11, D10), with the content consisting of a binary floating point number.

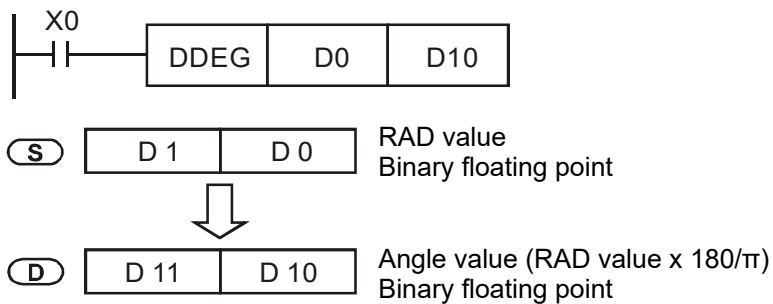

API 120	D	EADD	P	(S1) (S2) (D)	Adding binary floating point numbers
------------	---	------	---	---------------	--------------------------------------

	Bit device			Word device								16-bit command					
	X	Y	M	K	H	KnX	KnY	KnM	T	C	D	-					
S1				*	*							*	-				
S2				*	*							*	32-bit command (9 STEP)				
D												*	DEADD	Continuous execution type	DEADDP	Pulse execution type	

Notes on operand usage:
Please refer to the function specifications table for each device in series for the scope of device usage

Flag signal: none

Explanation

- **S₁**: addend. **S₂**: augend. **D**: sum.
- When the content of the register designated by **S₂** is added to the content of the register designated by **S₁**, and the result is stored in the register designated by **D**. Addition is performed entirely using binary floating-point numbers.
- **If the source operand S₁ or S₂ designates a constant K or H, the command will transform that constant into a binary floating point number for use in addition.**
- **In the situation when S₁ and S₂ designate identical register numbers, if a "continuous execution" command is employed, when conditional contact is On, the register will perform addition once during each scan. Pulse execution type commands (DEADDP) are generally used under ordinary circumstances.**

Example

- When X0=On, a binary floating point number (D1, D0) will be added to a binary floating point number (D3, D2), and the results stored in (D11, D10).

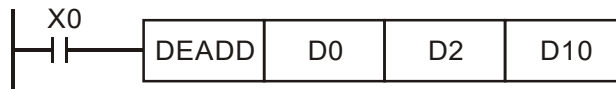

- When X2 =On, a binary floating point number (D11, D10) will be added to K1234 (which has been automatically converted to a binary floating-point number), and the results stored in (D21, D20).

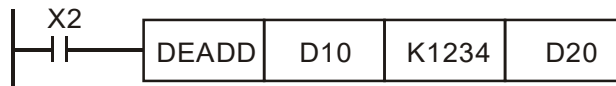

API 121	D	ESUB	P	(S1)	(S2)	(D)	Subtraction of binary floating point numbers							
Bit device			Word device								16-bit command			
X	Y	M	K	H	KnX	KnY	KnM	T	C	D	-	-	-	-
S1			*	*						*	32-bit command (13 STEP)			
S2			*	*						*	DESUB	Continuous execution type	DESUBP	Pulse execution type
D										*	Flag signal: none			
Notes on operand usage: Please refer to the function specifications table for each device in series for the scope of device usage														

Explanation

- **S₁**: minuend. **S₂**: subtrahend. **D**: difference.
- When the content of the register designated by **S₂** is subtracted from the content of the register designated by **S₁**, the difference will be stored in the register designated by **D**; subtraction is performed entirely using binary floating-point numbers.
- **If the source operand S₁ or S₂ designates a constant K or H, the command will transform that constant into a binary floating point number for use in subtraction.**
- **In the situation when S₁ and S₂ designate identical register numbers, if a "continuous execution" command is employed, when conditional contact is On, the register will perform addition once during each scan. Pulse execution type commands (DESUBP) are generally used under ordinary circumstances.**

Example

- When X0=On, a binary floating point number (D1, D0) will be subtracted to a binary floating point number (D3, D2), and the results stored in (D11, D10).

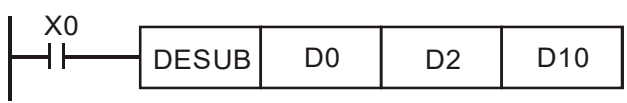

- When X2 =On, the binary floating point number (D1, D0) will be subtracted from K1234 (which has been automatically converted to a binary floating-point number), and the results stored in (D11, D10).



API 122	D	EMUL	P	(S ₁)	(S ₂)	(D)	Multiplication of binary floating point numbers											
Bit device			Word device								16-bit command							
	X	Y	M	K	H	KnX	KnY	KnM	T	C	D	-						
S1				*	*						*	-						
S2				*	*						*	-						
D											*	-						
Notes on operand usage: Please refer to the function specifications table for each device in series for the scope of device usage												32-bit command (13 STEP)						
												DEMUL	Continuous execution type	DEMULP	Pulse execution type			
												Flag signal: none						

Explanation

- **S₁**: multiplicand. **S₂**: multiplier. **D**: product.
- When the content of the register designated by **S₁** is multiplied by the content of the register designated by **S₂**, the product will be stored in the register designated by **D**; multiplication is performed entirely using binary floating-point numbers.
- **If the source operand S₁ or S₂ designates a constant K or H, the command will transform that constant into a binary floating point number for use in multiplication.**
- **In the situation when S₁ and S₂ designate identical register numbers, if a "continuous execution" command is employed, when conditional contact is On, the register will perform multiplication once during each scan. Pulse execution type commands (DEMULP) are generally used under ordinary circumstances.**

Example

- When X1=On, the binary floating point number (D1, D0) will be multiplied by the binary floating point number (D11, D10), and the product will be stored in the register designated by (D21, D20).

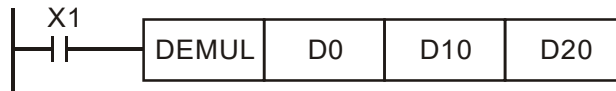

- When X2 =On, the binary floating point number (D1, D0) will be multiplied from K1234 (which has been automatically converted to a binary floating-point number), and the results stored in (D11, D10).

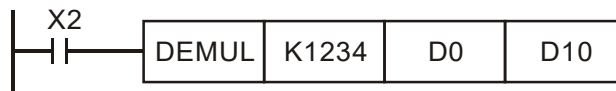

API 123	D	EDIV	P	(S ₁)	(S ₂)	(D)	Division of binary floating point numbers							
Bit device			Word device								16-bit command			
X	Y	M	K	H	KnX	KnY	KnM	T	C	D	-	-	-	-
S1			*	*						*	32-bit command (13 STEP)			
S2			*	*						*	DEDIV : Continuous execution type			
D										*	DEDIVP : Pulse execution type			
Notes on operand usage: Please refer to the function specifications table for each device in series for the scope of device usage											Flag signal: none			

- Explanation**
- ◆ **S₁**: dividend. **S₂**: divisor. **D**: quotient and remainder.
 - ◆ When the content of the register designated by **S₁** is divided by the content of the register designated by **S₂**, the quotient will be stored in the register designated by **D**; division is performed entirely using binary floating-point numbers.
 - **If the source operand S₁ or S₂ designates a constant K or H, the command will transform that constant into a binary floating point number for use in division.**

Example

- ◆ When X1=On, the binary floating point number (D1, D0) will be divided by the binary floating point number (D11, D10), and the quotient stored in the register designated by (D21, D20).

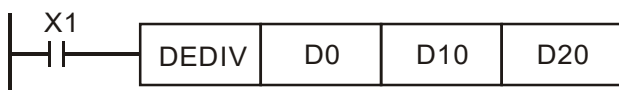

- ◆ When X2 =On, the binary floating point number (D1, D0) will be divided by K1,234 (which has been automatically converted to a binary floating-point number), and the results stored in (D11, D10).

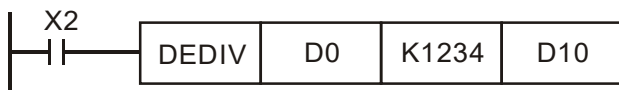

API 124	D	EXP	P	(S) (D)	Binary floating point number obtain exponent												
	Bit device			Word device								16-bit command					
	X	Y	M	K	H	KnX	KnY	KnM	T	C	D	- - - -					
S				*	*						*	-					
D											*	-					
Notes on operand usage: Please refer to the function specifications table for each device in series for the scope of device usage												32-bit command (9 STEP)					
												DEXP	Continuous execution type	DEXPP	Pulse execution type		
												Flag signal: none					

Explanation

- **S**: operation source device. **D**: operation results device.
- Taking $e = 2.71828$ as a base, **S** is the exponent in the EXP operation.
- $[D + 1, D] = EXP[S + 1, S]$
- Valid regardless of whether the content of **S** has a positive or negative value. The designated register D must have a 32-bit data format. This operation is performed using floating-point numbers, and **S** must therefore be converted to a floating point number.
- Content of operand **D** = e^S ; $e = 2.71828$, **S** is the designated source data

Example

- When M0 is On, the value of (D11, D10) will be converted to a binary floating point number, which will be stored in register (D21, D20).
- When M1 is On, the EXP operation is performed on the exponent of (D11, D10); its value is a binary floating point number stored in register (D21, D20).

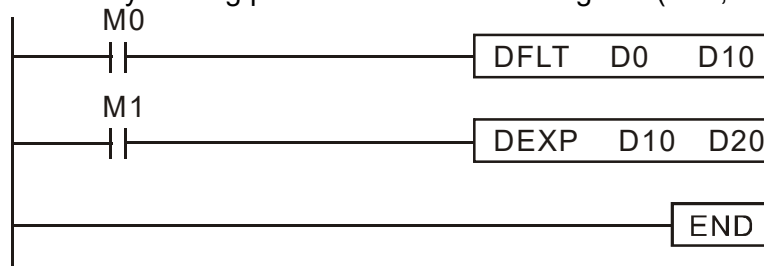

API 127	D	ESQR	P	(S) (D)	Binary floating point number find square root										
Bit device		Word device										16-bit command			
X	Y	M	K	H	KnX	KnY	KnM	T	C	D	- - - -				
S			*	*						*	-				
D										*	32-bit command (9 STEP)				
Notes on operand usage: Please refer to the function specifications table for each device in series for the scope of device usage										DESQR	Continuous	DESQR	Pulse		
										execution type	P	execution type			
										Flag signal: none					

Explanation

- **S**: source device for which square root is desired **D**: result of finding square root.
- When the square root is taken of the content of the register designated by **S**, the result is temporarily stored in the register designated by **D**. Taking square roots is performed entirely using binary floating-point numbers.
- If the source operand **S** refers to a constant K or H, the command will transform that constant into a binary floating point number for use in the operation.

Example

- When X0=On, the square root is taken of the binary floating point number (D1, D0), and the result is stored in the register designated by (D11, D10).

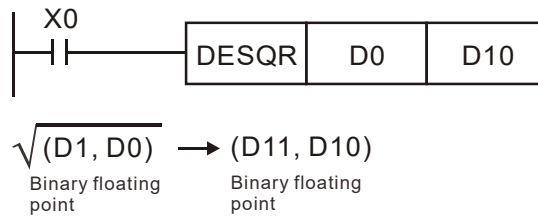

- When X2 =On, the square root is taken of K1,234 (which has been automatically converted to a binary floating-point number), and the results stored in (D11, D10).



API 129	D	INT	P	(S)	(D)	Binary floating point number → BIN whole number transformation									
Bit device		Word device										16-bit command			
X	Y	M	K	H	KnX	KnY	KnM	T	C	D	-	-	-	-	
S										*	32-bit command (9 STEP)				
D										*	DINT	Continuous	DINTP	Pulse	
Notes on operand usage: Please refer to the function specifications table for each device in series for the scope of device usage										execution type					
										Flag signal: none					

- Explanation**
- **S**: the source device to be transformed. **D**: results of transformation.
 - The content of the register designated by **S** is transformed from a binary floating point number format into a BIN whole number, and is temporarily stored in **D**. The BIN whole number floating point number will be discarded.
 - The action of this command is the opposite of that of command API 49 (FLT).
- Example**
- When X0=On, the binary floating point number (D1, D0) is transformed into a BIN whole number, and the result is stored in (D10); the BIN whole number floating point number will be discarded.

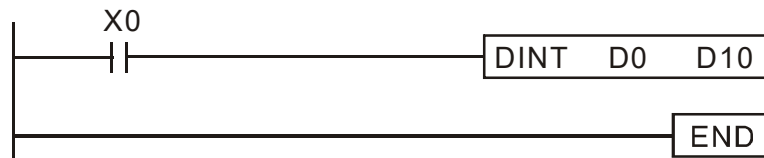

API 130	D	SIN	P	(S) (D)	Binary floating point number SIN operation										
	Bit device			Word device							16-bit command				
	X	Y	M	K	H	KnX	KnY	KnM	T	C	D	-			
S				*	*						*	-			
D											*	32-bit command (9 STEP)			
Notes on operand usage: Please refer to the function specifications table for each device in series for the scope of device usage											DSIN	Continuous execution type	DSINP	Pulse execution type	
											Flag signal: none				

Explanation

- **S**: the designated source value. **D**: the SIN value result.
- **S** is the designated source in radians.
- The value in radians (RAD) is equal to (angle $\times \pi/180$).
- The SIN obtained from the source value designated by **S** is stored in **D**.

The following figure displays the relationship between the arc and SIN results:

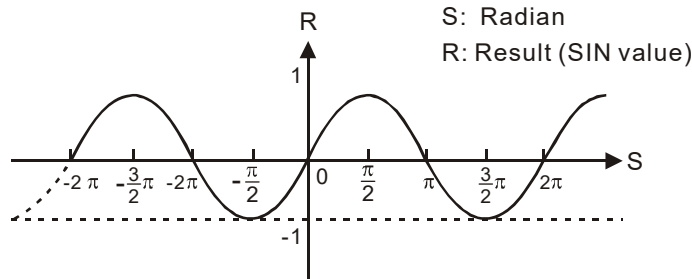

Example

- When X0=On, the SIN value of the designated binary floating point number (D1, D0) in radians (RAD) will be stored in (D11, D10), with the content consisting of a binary floating point number.

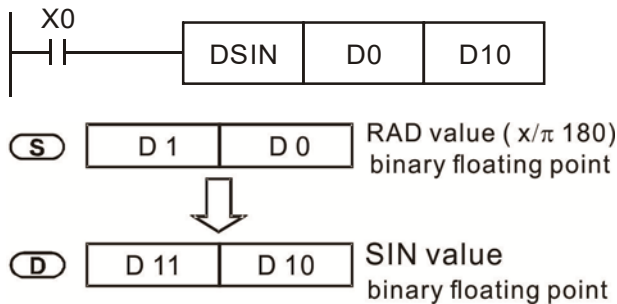

API 131	D	COS	P	(S) (D)	Binary floating point number COS operation									
Bit device		Word device								16-bit command				
X	Y	M	K	H	KnX	KnY	KnM	T	C	D	-			
S			*	*						*	32-bit command (9 STEP)			
D										*	DCOS	Continuous execution type	DCOSP	Pulse execution type
Notes on operand usage: Please refer to the function specifications table for each device in series for the scope of device usage											Flag signal: none			

Explanation

- **S**: the designated source value. **D**: the COS value result.
- The source designated by S can be given as radians or an angle; this is decided by flag M1018.
- When M1018=Off, the operation is in radians mode, where the radians (RAD) value is equal to (angle ×π/180).
- When M1018=On, the operation is in the angle mode, where the angular range is 0° ≤ angle <360°.
- When calculation results yield 0, M1020=On.
- The COS obtained from the source value designated by **S** is stored in **D**.

The following figure displays the relationship between the arc and SIN results:

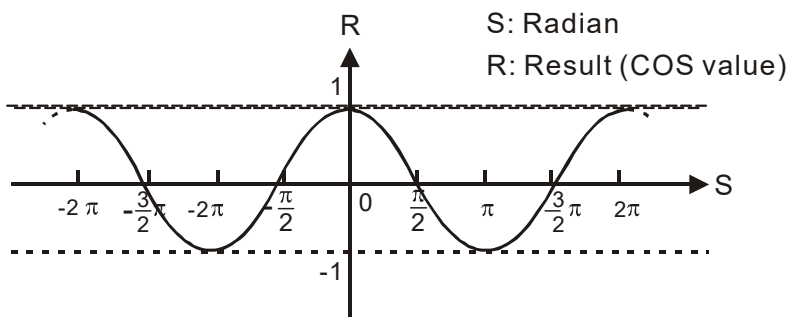

Example

- When X0=On, the COS value of the designated binary floating point number (D1, D0) in radians will be stored in (D11, D10), with the content consisting of a binary floating point number.

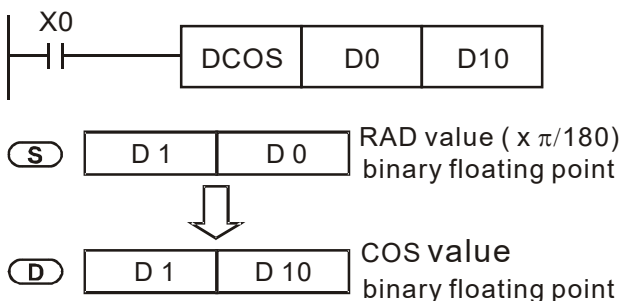

API 132	D	TAN	P	(S) (D)	Binary floating point number TAN operation													
Bit device			Word device								16-bit command							
X	Y	M	K	H	KnX	KnY	KnM	T	C	D	-							
S			*	*						*	-							
D										*	-							
Notes on operand usage: Please refer to the function specifications table for each device in series for the scope of device usage											DTAN : Continuous execution type				DTANP : Pulse execution type			
Flag signal: none																		

Explanation

- **S**: the designated source value. **D**: the TAN value result.
- The source designated by **S** can be given as radians or an angle; this is decided by flag M1018.
- When M1018=Off, the operation is in radians mode, where the radians (RAD) value is equal to (angle × π/180).
- When M1018=On, the operation is in the angle mode, where the angular range is 0° ≤ angle < 360°.
- When calculation results yield 0, M1020=On.
- The TAN obtained from the source value designated by **S** is stored in **D**.

The following figure displays the relationship between the arc and SIN results:

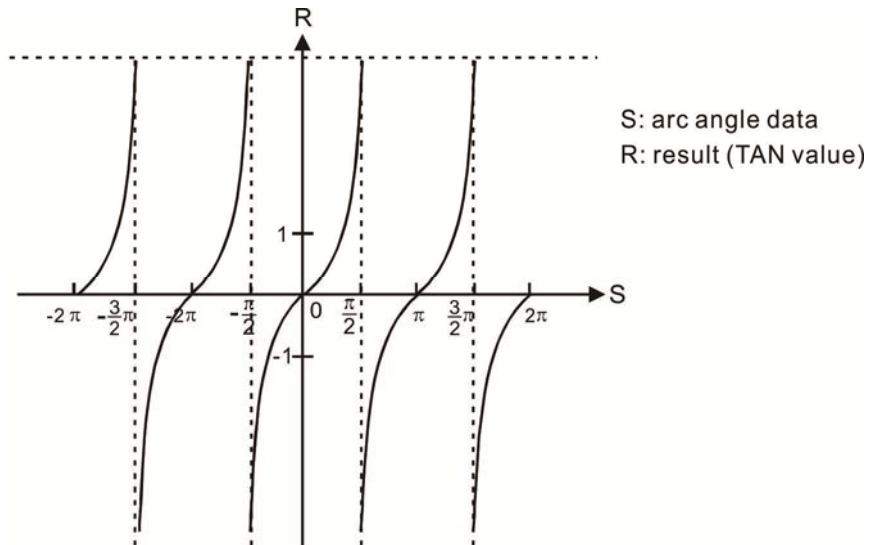

Example

- When X0=On, the TAN value of the designated binary floating point number (D1, D0) in radians (RAD) will be stored in (D11, D10), with the content consisting of a binary floating point number.

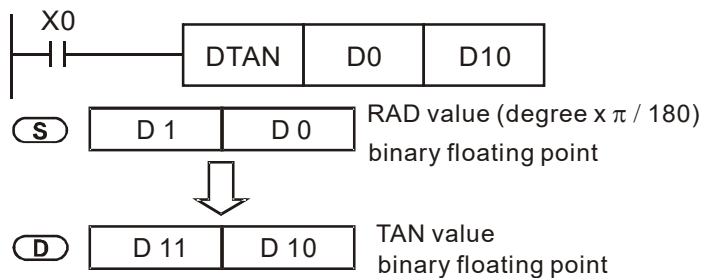

API 133	D	ASIN	P	(S) (D)	Binary floating point number ASIN operation									
Bit device		Word device							16-bit command					
X	Y	M	K	H	KnX	KnY	KnM	T	C	D	-	-	-	-
S			*	*						*	32-bit command (9 STEP)			
D										*	DASIN	Continuous execution type	DASINP	Pulse execution type
Notes on operand usage: Please refer to the function specifications table for each device in series for the scope of device usage											Flag signal: none			

Explanation

- **S**: the designated source (binary floating point number). **D**: the ASIN value result.
- ASIN value = \sin^{-1}

The figure below shows the relationship between input data and result:

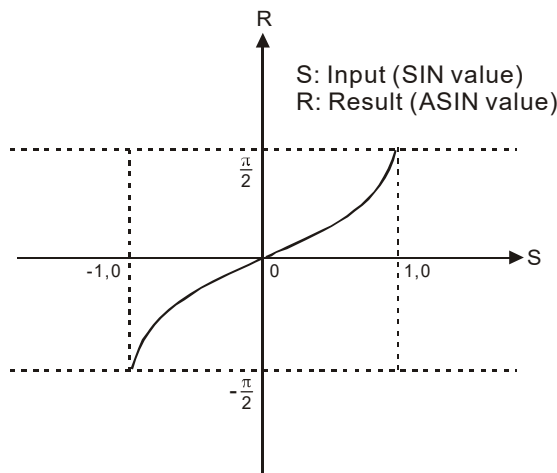

Example

- When X0=On, the ASIN value obtained from the designated binary floating point number (D1, D0) will be stored in (D11, D10), with the content consisting of a binary floating point number.

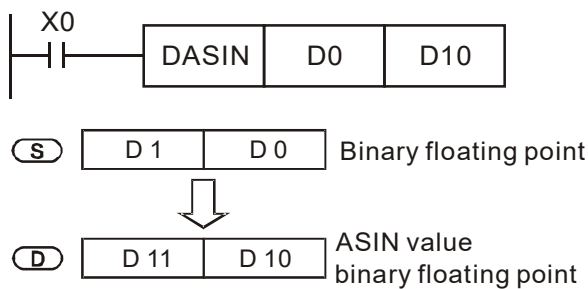

API 134	D	ACOS	P									Binary floating point number ACOS operation			
Bit device		Word device										16-bit command			
X	Y	M	K	H	KnX	KnY	KnM	T	C	D	-	-	-	-	
S			*	*						*	32-bit command (9 STEP)				
D										*	DACOS	Continuous	DACOS	Pulse	
Notes on operand usage: Please refer to the function specifications table for each device in series for the scope of device usage											execution type	P	execution type		
											Flag signal: none				

Explanation

- **S**: the designated source (binary floating point number). **D**: the ACOS value result.
- ACOS value = \cos^{-1}

The figure below shows the relationship between input data and result:

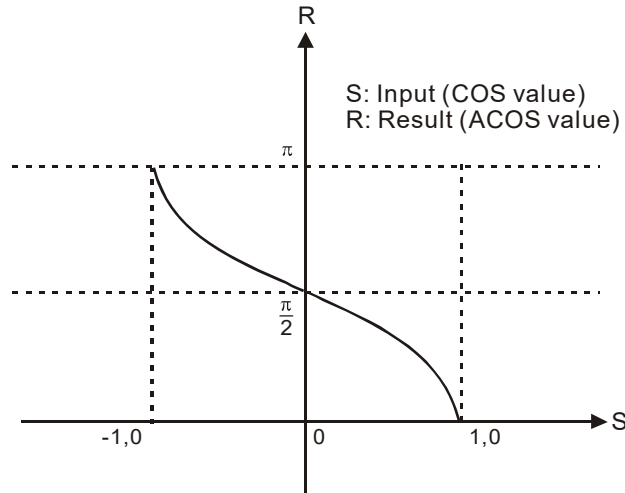

Example

- When X0=On, the ACOS value obtained from the designated binary floating point number (D1, D0) will be stored in (D11, D10), with the content consisting of a binary floating point number.

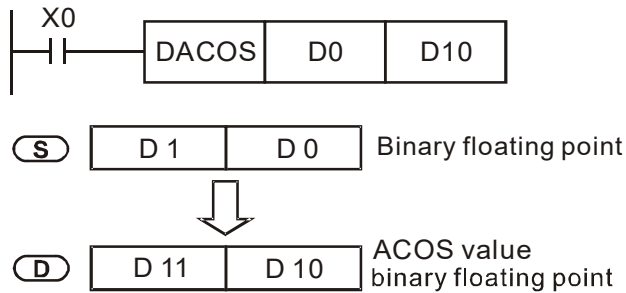

API 135	D	ATAN	P	(S) (D)	Binary floating point number ATAN operation										
	Bit device			Word device							16-bit command				
	X	Y	M	K	H	KnX	KnY	KnM	T	C	D	- - - -			
S				*	*						*	32-bit command (9 STEP)			
D											*	DATAN : Continuous execution type DATANP : Pulse execution type			
Notes on operand usage: Please refer to the function specifications table for each device in series for the scope of device usage												Flag signal: none			

- Explanation
- **S**: the designated source (binary floating point number). **D**: the ATAN value result.
 - ATAN value = \tan^{-1}

The figure below shows the relationship between input data and result:

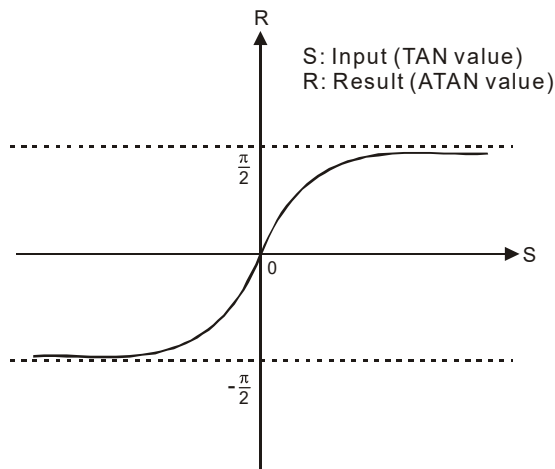

- Example
- When X0=On, the TAN value obtained from the designated binary floating point number (D1, D0) will be stored in (D11, D10), with the content consisting of a binary floating point number.

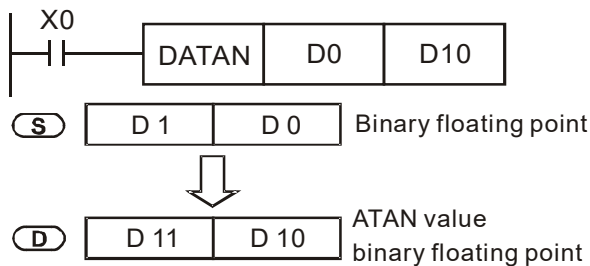

API 136	D	SINH	P	(S) (D)	Binary floating point number SINH operation										
	Bit device			Word device								16-bit command			
	X	Y	M	K	H	KnX	KnY	KnM	T	C	D	- - - -			
S				*	*						*	32-bit command (9 STEP)			
D											*	DSINH : Continuous execution type DSINHHP : Pulse execution type			
Notes on operand usage: Please refer to the function specifications table for each device in series for the scope of device usage												Flag signal: none			

- Explanation**
- **S**: the designated source (binary floating point number). **D**: the SINH value result.
 - $SINH\ value = (e^s - e^{-s}) / 2$

- Example**
- When X0=On, the SINH value obtained from the designated binary floating point number (D1, D0) will be stored in (D11, D10), with the content consisting of a binary floating point number.

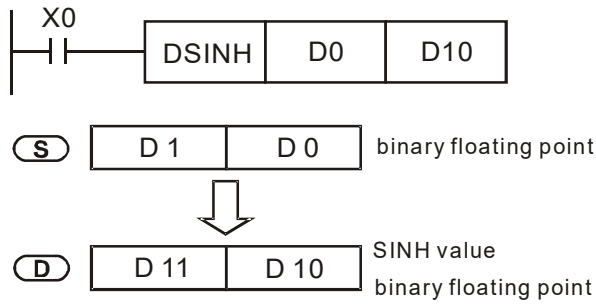

API 137	D	COSH	P	(S) (D)	Binary floating point number COSH operation									
Bit device			Word device								16-bit command			
X	Y	M	K	H	KnX	KnY	KnM	T	C	D	-	-	-	-
S			*	*						*	32-bit command (9 STEP)			
D										*	DCOSH	Continuous execution type	DCOSH P	Pulse execution type
Notes on operand usage: Please refer to the function specifications table for each device in series for the scope of device usage											Flag signal: none			

- Explanation
- **S**: the designated source (binary floating point number). **D**: the COSH value result.
 - $\text{COSH value} = (e^s + e^{-s}) / 2$

- Example
- When X0=On, the COSH value obtained from the designated binary floating point number (D1, D0) will be stored in (D11, D10), with the content consisting of a binary floating point number.

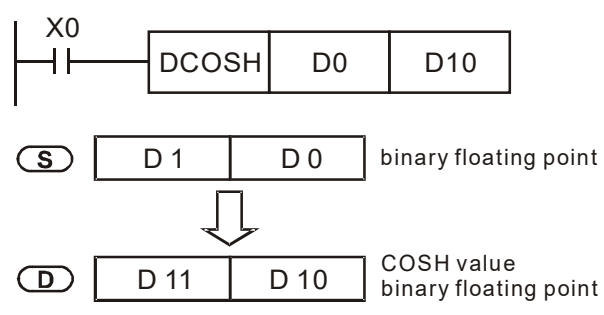

API 138	D	TANH	P	(S)	(D)	Binary floating point number TANH operation								
Bit device		Word device									16-bit command			
X	Y	M	K	H	KnX	KnY	KnM	T	C	D	- - - -			
S			*	*						*	32-bit command (9 STEP)			
D										*	DTANH : Continuous : DTANHP : Pulse execution type : execution type			
Notes on operand usage: Please refer to the function specifications table for each device in series for the scope of device usage											Flag signal: none			

Explanation

- **S**: the designated source (binary floating point number). **D**: the TANH value result.
- $\tanh \text{ value} = (e^S - e^{-S}) / (e^S + e^{-S})$

Example

- When X0=On, the TANH value obtained from the designated binary floating point number (D1, D0) will be stored in (D11, D10), with the content consisting of a binary floating point number.

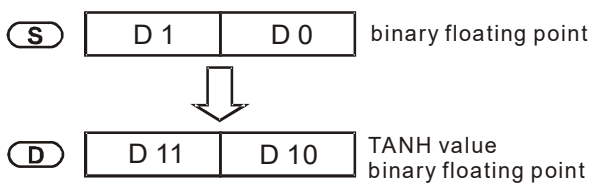
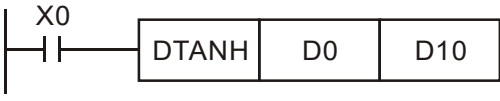

API 160	TCMP		P	(S₁)	(S₂)	(S₃)	(S)	(D)	Comparison of calendar data						
Bit device			Word device									16-bit command (11 STEP)			
	X	Y	M	K	H	KnX	KnY	KnM	T	C	D	TCMP	Continuous execution type	TCMPP	Pulse execution type
S1				*	*	*	*	*	*	*	*				
S2				*	*	*	*	*	*	*	*				
S3				*	*	*	*	*	*	*	*				
S									*	*	*				
D		*	*												
Notes on operand usage: Please refer to the function specifications table for each device in series for the scope of device usage											Flag signal: none				

- Explanation**
- **S₁**: Sets the hours of the comparison time, setting range is "K0-K23." **S₂**: Sets the minutes of the comparison time, setting range is "K0-K59." **S₃**: Sets the seconds of the comparison time, setting range is "K0-K59." **S**: current calendar time. **D**: Results of comparison.
 - Compares the time in hours, minutes, and seconds set in **S₁ - S₃** with the current calendar time in hours, minutes, and seconds, with the results of comparison expressed in **D**.
 - **S** The hour content of the current calendar time is "K0-K23." **S + 1** comprises the minutes of the current calendar time, and consists of "K0-K59." **S + 2** comprises the seconds of the current calendar time, and consists of "K0-K59."
 - The current calendar time designated by **S** is usually compared using the TCMP command after using the TRD command to read the current calendar time. If the content value of **S** exceeds the range, this is considered an operating error, the command will not execute, and M1068=On.

- Example**
- When X10=On, the command will execute, and the current calendar time in D20-D22 will be compared with the preset value of 12:20:45; the results will be displayed in M10-M12. When X10 On→Off, the command will not be executed, but the On/Off status prior to M10-M12 will be maintained.
 - If results in the form of \geq , \leq , or \neq are needed, they can be obtained by series and parallel connection of M10-M12.

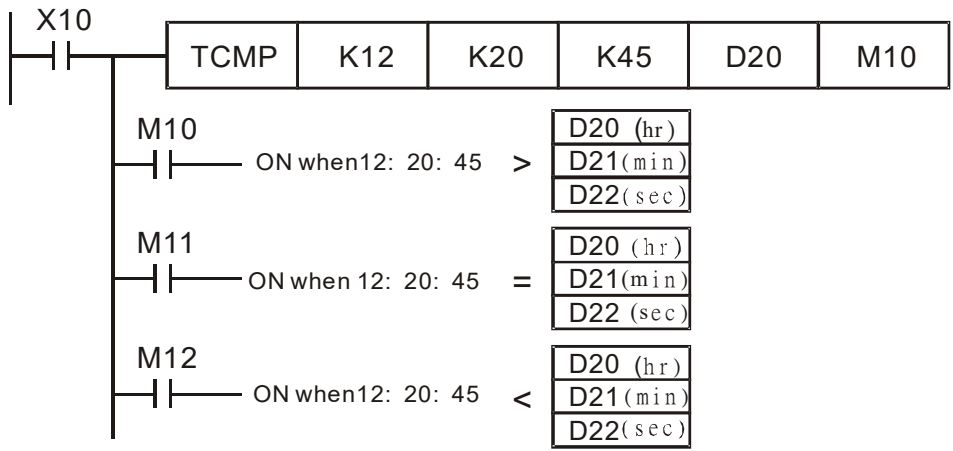

API 161	TZCP	P	S₁ S₂ S D	Comparison of calendar data
------------	------	---	---	-----------------------------

	Bit device			Word device								16-bit command (9 STEP)			
	X	Y	M	K	H	KnX	KnY	KnM	T	C	D	TZCP	Continuous execution type	TZCPP	Pulse execution type
S1									*	*	*				
S2									*	*	*				
S									*	*	*				
D		*	*												

Notes on operand usage:
Please refer to the function specifications table for each device in series for the scope of device usage

Flag signal: none

Explanation

- **S₁**: Sets the lower limit of the comparison time. **S₂**: Sets the upper limit of the comparison time. **S**: current calendar time. **D**: Results of comparison.
- Performs range comparison by comparing the hours, minutes, and seconds of the current calendar time designated by **S** with the lower limit of the comparison time set as **S₁** and the upper limit of the comparison time set as **S₂**, and expresses the results of comparison in **D**.
- **S₁ · S₁ +1 · S₁ +2**: Sets the hours, minutes, and seconds of the lower limit of the comparison time.
- **S₂ · S₂ +1 · S₂ +2**: Sets the hours, minutes, and seconds of the upper limit of the comparison time.
- **S · S +1 · S +2**: The hours, minutes, and seconds of the current calendar time
- The D0 designated by the **S** listed in this program is usually obtained by comparison using the TZCP command after using the TRD command in advance to read the current calendar time. If the value of **S₁**, **S₂**, or **S** exceeds the range, this is considered an operating error, the command will not execute, and M1068=On.
- When the current time **S** is less than the lower limit value **S₁** and **S** is less than the upper limit value **S₂**, **D** will be On. When the current time **S** is greater than the lower limit value **S₁** and **S** is greater than the upper limit value **S₂**, **D +2** will be On; **D +1** will be On under other conditions.

Example

- When X10=On, the TZCP command executes, and one of M10-M12 will be On. When X10=Off, the TZCP command will not execute, and M10-M12 will remain in the X10=Off state.

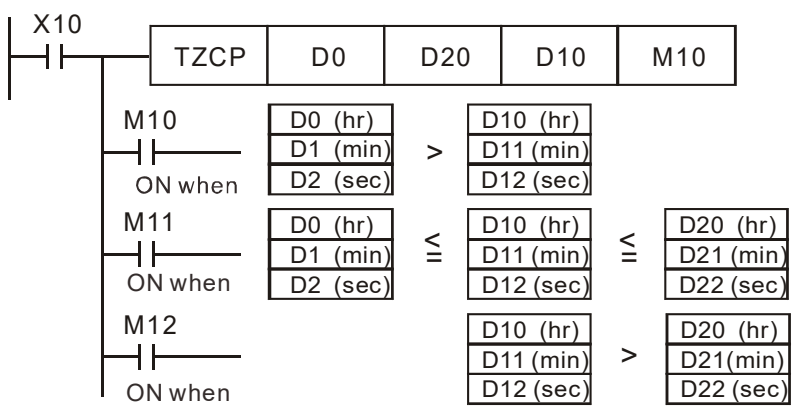

API 162	TADD			P	S1 S2 D							Calendar data addition			
Bit device				Word device								16-bit command (7 STEP)			
	X	Y	M	K	H	KnX	KnY	KnM	T	C	D	TADD	Continuous execution type	TADDP	Pulse execution type
S1									*	*	*				
S2									*	*	*				
D									*	*	*				
Notes on operand usage: Please refer to the function specifications table for each device in series for the scope of device usage												32-bit command _____ _____ _____ _____			
												• Flag signal: M1020 Zero flag M1022 Carry flag M1068 Calendar error			

- Explanation**
- **S1**: time addend. **S2**: time augend. **D**: time sum.
 - The calendar data in hours, minutes, and seconds designated by **S2** is added to the calendar data in hours, minutes, and seconds designated by **S1**, and the result is stored as hours, minutes, and seconds in the register designated by **D**.
 - If the value of **S1** or **S2** exceeds the range, this is considered an operating error, the command will not execute, M1067, M1068=On, and D1067 will record the error code 0E1A (HEX).
 - If the results of addition are greater than or equal to 24 hours, carry flag M1022=On, and **D** will display the results of addition minus 24 hours.
 - If the results of addition are equal to 0 (0 hours, 0 minutes, 0 seconds), zero flag M1020=On.

- Example**
- When X10=On, the TADD command will be executed, and the calendar data in hours, minutes, and seconds designated by D0 to D2 will be added to the calendar data in hours, minutes, and seconds designated by D10 to D12, and the results are stored as a total number of hours, minutes, and seconds in the registers designated by D20 to D22.

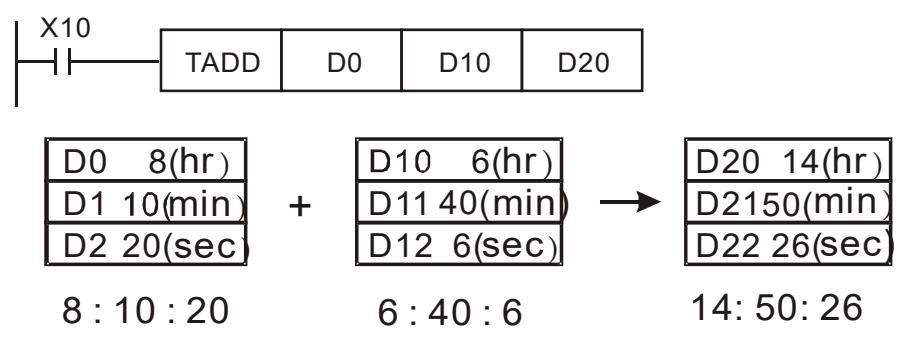

API 163	TSUB		P	<div style="display: flex; justify-content: space-around;"> S₁ S₂ D </div>								Calendar data subtraction			
Bit device			Word device									16-bit command (7 STEP)			
X	Y	M	K	H	KnX	KnY	KnM	T	C	D	TSUB	Continuous execution type	TSUBP	Pulse execution type	
S1								*	*	*	32-bit command				
S2								*	*	*					
D								*	*	*	<ul style="list-style-type: none"> Flag signal: M1020 Zero flag M1022 Carry flag M1068 Calendar error 				
Notes on operand usage: Please refer to the function specifications table for each device in series for the scope of device usage															

Explanation

- **S₁**: time minuend. **S₂**: time augend. **D**: time sum.
- Subtracts the calendar data in hours, minutes, and seconds designated by **S₂** from the calendar data in hours, minutes, and seconds designated by **S₁**, and the result is temporarily stored as hours, minutes, and seconds in the register designated by **D**.
- If the value of **S₁** or **S₂** exceeds the range, this is considered an operating error, the command will not execute, M1067, M1068=On, and D1067 will record the error code 0E1A (HEX).
- If subtraction results in a negative number, borrow flag M1021=On, and the result of that negative number plus 24 hours will be displayed in the register designated by **D**.
- If the results of subtraction are equal to 0 (0 hours, 0 minutes, 0 seconds), zero flag M1020=On.

Example

- When X10=On, the TADD command will be executed, and the calendar data in hours, minutes, and seconds designated by D10 to D12 will be subtracted from the calendar data in hours, minutes, and seconds designated by D0 to D2, and the results are stored as a total number of hours, minutes, and seconds in the registers designated by D20 to D22.

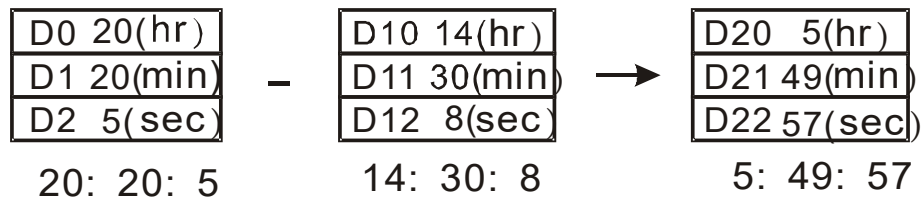
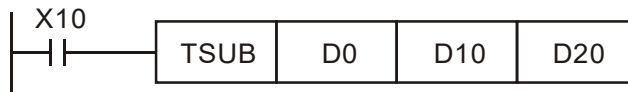

API 166		TRD		D								Calendar data read			
Bit device			Word device									16-bit command (3 STEP)			
X	Y	M	K	H	KnX	KnY	KnM	T	C	D	TRD	Continuous execution type	120	Pulse execution type	
D								*	*	*					
Notes on operand usage: Please refer to the function specifications table for each device in series for the scope of device usage											32-bit command				
											• Flag signal: none				

- Explanation**
- **S₁**: time minuend. **S₂**: time augend. **D**: time sum.
 - **D**: device used to store the current calendar time after reading.
 - The EH/EH2/SV/EH3/SV2/SA/SX/SC main units have a built-in calendar clock, and the clock provides seven sets of data comprising year, week, month, day, hour, minute, and second stored in D1063 to D1069. The TRD command function allows program designers to directly read the current calendar time into the designated seven registers.
 - D1063 only reads the two right digits of the Western calendar year.
- Example**
- When X0=On, the current calendar time is read into the designated registers D0 to D6.
 - In D1064, 1 indicates Monday, 2 indicates Tuesday, and so on, with and 7 indicating Sunday.

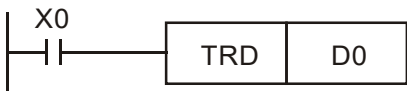

Special D	Item	Content		General D	Item
D1063	Year (Western)	00~99	→	D0	Year (Western)
D1064	Weeks	1~7	→	D1	Weeks
D1065	Month	1~12	→	D2	Month
D1066	Day	1~31	→	D3	Day
D1067	Hour	0~23	→	D4	Hour
D1068	Minute	0~59	→	D5	Minute
D1069	Second	0~59	→	D6	Second

API 170	D	GRY	P	(S) (D)	BIN→GRAY code transformation										
	Bit device			Word device								16-bit command (5 STEP)			
	X	Y	M	K	H	KnX	KnY	KnM	T	C	D	GRY	Continuous execution type	GRYP	Pulse execution type
S				*	*	*	*	*	*	*	*				
D							*	*	*	*	*				
Notes on operand usage: Please refer to the function specifications table for each device in series for the scope of device usage												32-bit command (9 STEP)			
												DGRY	Continuous execution type	DGRYP	Pulse execution type
• Flag signal: none															

Explanation

- **S**: source device. **D**: device storing GRAY code.
- Transforms the content value (BIN value) of the device designated by **S** to GRAY code, which is stored in the device designated by **D**.
- The valid range of **S** is as shown below; if this range is exceeded, it will be considered an error, and the command will not execute.

16-bit command: 0~32,767

- 32-bit command: 0~2,147,483,647

Example

- When X0=On, the constant K6513 will be transformed to GRAY code and stored in D0.

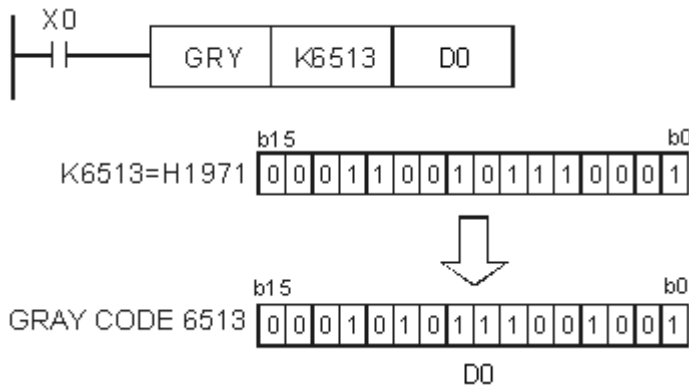

API 171	D	GBIN	P	(S) (D)	GRAY code →BIN transformation										
	Bit device			Word device								16-bit command (5 STEP)			
	X	Y	M	K	H	KnX	KnY	KnM	T	C	D	GBIN	Continuous execution type	GBINP	Pulse execution type
S				*	*	*	*	*	*	*	*				
D							*	*	*	*	*				
Notes on operand usage: Please refer to the function specifications table for each device in series for the scope of device usage												32-bit command (9 STEP)			
												DGBIN	Continuous execution type	DGBINP	Pulse execution type
• Flag signal: none															

- Explanation**
- **S**: source device used to store GRAY code. **D**: device used to store BIN value after transformation.
 - The GRAY code corresponding to the value of the device designated by **S** is transformed into a BIN value, which is stored in the device designated by **D**.
 - This command will transform the value of the absolute position encoder connected with the PLC's input and (this encoder usually has an output value in the form of GRAY code) into a BIN value, which is stored in the designated register.
 - The valid range of **S** is as shown below; if this range is exceeded, it will be considered an error, and the command will not execute.
 - 16-bit command: 0~32,767
 - 32-bit command: 0~2,147,483,647

Example

- When X20=On, the GRAY code of the absolute position encoder connected with input points X0 to X17 will be transformed into BIN value and stored in D10.

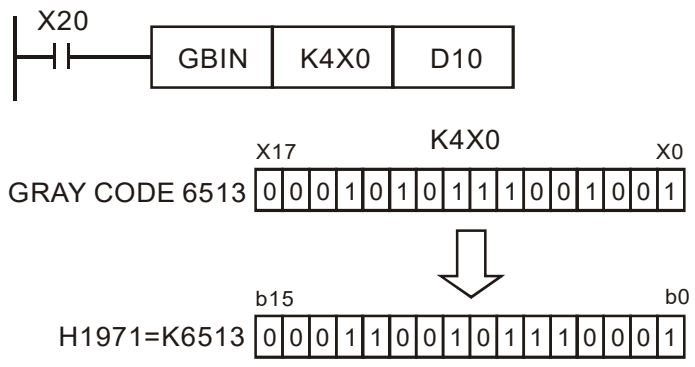

API 215~ 217	D	LD#	(S1)	(S2)	Contact form logical operation LD#									
Bit device			Word device								16-bit command (5 STEP)			
X	Y	M	K	H	KnX	KnY	KnM	T	C	D	LD#	Continuous execution type	—	—
S1			*	*	*	*	*	*	*	*				
S2			*	*	*	*	*	*	*	*				
Notes on operand usage: # : & \ · \ ^											32-bit command (9 STEP)			
Please refer to the function specifications table for each device in series for the range of device usage											DLD#	Continuous execution type	—	—
											Flag signal: none			

Explanation

- **S₁**: data source device 1. **S₂**: data source device 2.
- This command performs comparison of the content of **S₁** and **S₂**; when the result of comparison is not 0, this command will be activated, but this command will not be activated when the result of comparison is 0.
- The LD#This command can be used while directly connected with the busbar

API No.	16-bit commands	32-bit commands	Conditions for activation				Conditions for inactivation			
215	LD&	DLD&	S₁	&	S₂	≠ 0	S₁	&	S₂	= 0
216	LD	DLD	S₁		S₂	≠ 0	S₁		S₂	= 0
217	LD^	DLD^	S₁	^	S₂	≠ 0	S₁	^	S₂	= 0

- &: logical AND operation.
- |: logical OR operation.
- ^: logical XOR operation.

Example

- When the content of C0 and C10 is subjected to the logical AND operation, and the result is not equal to 0, Y10=On.
- When the content of D200 and D300 is subjected to the logical OR operation, and the result is not equal to 0, and X1=On, Y11=On and remains in that state.

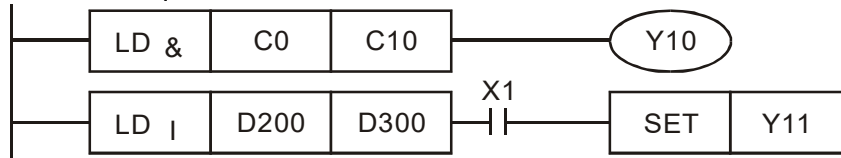

API 218~ 220	D	AND#	(S1)	(S2)	Contact form logical operation AND#									
Bit device			Word device								16-bit command (5 STEP)			
X	Y	M	K	H	KnX	KnY	KnM	T	C	D	AND#	Continuous execution type	—	—
S1			*	*	*	*	*	*	*	*				
S2			*	*	*	*	*	*	*	*				
Notes on operand usage: # : & · · ^											32-bit command (9 STEP)			
Please refer to the function specifications table for each device in series for the scope of device usage											DAND#	Continuous execution type	—	—
											Flag signal: none			

Explanation

- **S₁**: data source device 1. **S₂**: data source device 2.
- This command performs comparison of the content of **S₁** and **S₂**; when the result of comparison is not 0, this command will be activated, but this command will not be activated when the result of comparison is 0.
- The AND# command is an operation command in series with the contact.

API No.	16-bit commands	32-bit commands	Conditions for activation			Conditions for inactivation				
218	AND&	DAND&	S₁	&	S₂	≠ 0	S₁	&	S₂	= 0
219	AND	DAND	S₁		S₂	≠ 0	S₁		S₂	= 0
220	AND^	DAND^	S₁	^	S₂	≠ 0	S₁	^	S₂	= 0

- &: logical AND operation.
- |: logical OR operation.
- ^: logical XOR operation.

Example

- When X0=On and the content of C0 and C10 is subjected to the logical AND operation, and the result is not equal to 0, Y10=On.
- When X1=Off and D10 and D0 is subjected to the logical OR operation, and the result is not equal to 0, Y11=On and remains in that state.
- When X2 =On and the content of the 32-bit register D200(D201) and 32-bit register D100(D101) is subjected to the logical XOR operation, and the result is not equal to 0 or M3=On, M50=On.

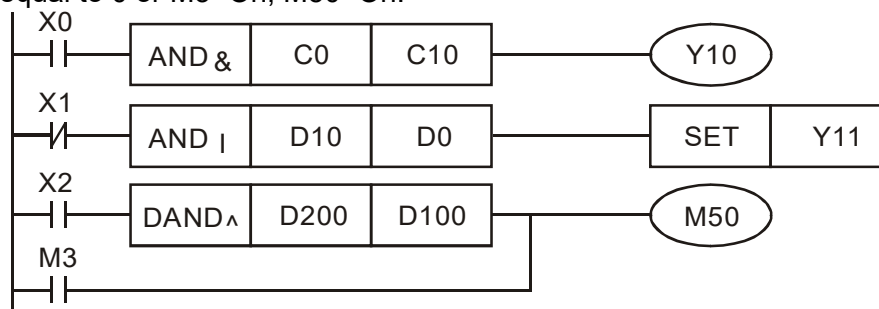

API 221~ 223	D	OR#	(S1)	(S2)	Contact form logical operation OR#										
Bit device			Word device									16-bit command (5 STEP)			
X	Y	M	K	H	KnX	KnY	KnM	T	C	D	OR#	Continuous execution type	—	—	
S1			*	*	*	*	*	*	*	*					
S2			*	*	*	*	*	*	*	*	32-bit command (9 STEP)				
Notes on operand usage: # : & · ^											DOR#	Continuous execution type	—	—	
Please refer to the function specifications table for each device in series for the scope of device usage											Flag signal: none				

Explanation

- **S₁**: data source device 1. **S₂**: data source device 2.
- This command performs comparison of the content of **S₁** and **S₂**; when the result of comparison is not 0, this command will be activated, but this command will not be activated when the result of comparison is 0.
- The OR# command is an operation command in series with the contact.

API No.	16-bit commands	32-bit commands	Conditions for activation		Conditions for inactivation		
221	OR&	DOR&	S₁ & S₂	≠ 0	S₁ & S₂	= 0	
222	OR	DOR	S₁ S₂	≠ 0	S₁ S₂	= 0	
223	OR^	DOR^	S₁ ^ S₂	≠ 0	S₁ ^ S₂	= 0	

- &: logical AND operation.
- |: logical OR operation.
- ^: logical XOR operation.

Example

- When X1=On or the content of C0 and C10 is subjected to the logical AND operation, and the result is not equal to 0, Y0=On.
- When X2 and M30 are both equal to On, or the content of 32-bit register D10 (D11) and 32-bit register D20 (D21) is subjected to the logical OR operation, and the result is not equal to 0, or the content of the 32-bit counter C235 and the 32-bit register D200 (D201) is subjected to the logical XOR operation, and the result is not equal to 0, M60=On.

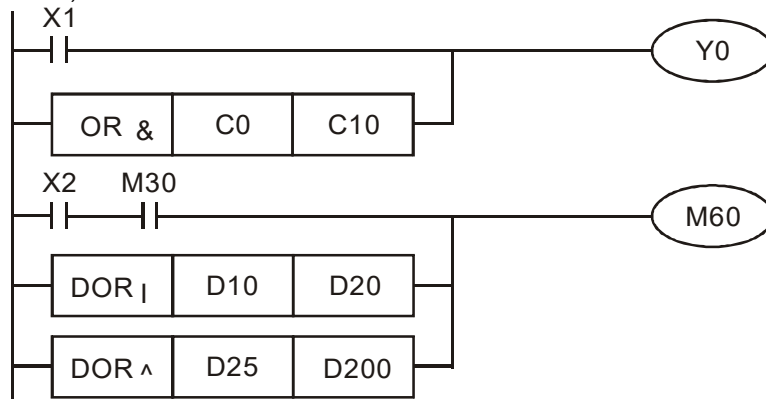

API 224~ 230	D	LD※	(S1)	(S2)	Contact form compare LD*									
Bit device			Word device								16-bit command (5 STEP)			
X	Y	M	K	H	KnX	KnY	KnM	T	C	D	LD※	Continuous execution type	—	—
S1			*	*	*	*	*	*	*	*				
S2			*	*	*	*	*	*	*	*				
Notes on operand usage: ※ : = , > , < , <> , ≤ , ≥			Please refer to the function specifications table for each device in series for the scope of device usage								32-bit command (9 STEP)			
											DLD※	Continuous execution type	—	—
											Flag signal: none			

- Explanation
- **S₁**: data source device 1. **S₂**: data source device 2.
 - This command compares the content of **S₁** and **S₂**. Taking API 224 (LD=) as an example, this command will be activated when the result of comparison is "equal," and will not be activated when the result is "unequal."
 - The LD* can be used while directly connected with the busbar

API No.	16-bit commands	32-bit commands	Conditions for activation	Conditions for inactivation
224	LD=	DLD=	S₁ = S₂	S₁ ≠ S₂
225	LD>	DLD>	S₁ > S₂	S₁ ≤ S₂
226	LD<	DLD<	S₁ < S₂	S₁ ≥ S₂
228	LD<>	DLD<>	S₁ ≠ S₂	S₁ = S₂
229	LD≤	DLD≤	S₁ ≤ S₂	S₁ > S₂
230	LD≥	DLD≥	S₁ ≥ S₂	S₁ < S₂

- Example
- When the content of C10 is equal to K200, Y10=On.
 - When the content of D200 is greater than K-30, and X1=On, Y11=On and remains in that state.

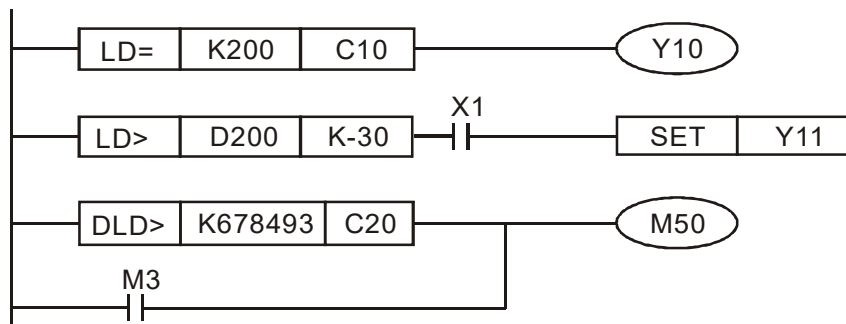

API 232~ 238	D	AND※	(S1)	(S2)	Contact form compare AND*										
Bit device		Word device										16-bit command (5 STEP)			
X	Y	M	K	H	KnX	KnY	KnM	T	C	D	AND※	Continuous execution type	—	—	
S1			*	*	*	*	*	*	*	*					
S2			*	*	*	*	*	*	*	*					
Notes on operand usage:		※ : = > < <> ≤ ≥										32-bit command (9 STEP)			
Please refer to the function specifications table for each device in series for the scope of device usage												DAND※	Continuous execution type	—	—
Flag signal: none															

Explanation

- **S₁**: data source device 1. **S₂**: data source device 2.
- This command compares the content of **S₁** and **S₂**. Taking API 232 (AND=) as an example, when the result of comparison is equal, this command will be activated; when the result of comparison is unequal, this command will not be activated.
- The AND* command is a comparison command in series with a contact.

API No.	16-bit commands	32-bit commands	Conditions for activation	Conditions for inactivation
232	AND=	DAND=	S₁ = S₂	S₁ ≠ S₂
233	AND>	DAND>	S₁ > S₂	S₁ ≤ S₂
234	AND<	DAND<	S₁ < S₂	S₁ ≥ S₂
236	AND<>	DAND<>	S₁ ≠ S₂	S₁ = S₂
237	AND≤	DAND≤	S₁ ≤ S₂	S₁ > S₂
238	AND≥	DAND≥	S₁ ≥ S₂	S₁ < S₂

Example

- When X0=On and the current value of C10 is also equal to K200, Y10=On.
- When X1=Off and the content of register D0 is not equal to K-10, Y11=On and remains in that state.
- When X2 =On and the content of the 32-bit register D0(D11)is less than 678,493, or M3=On, M50=On.

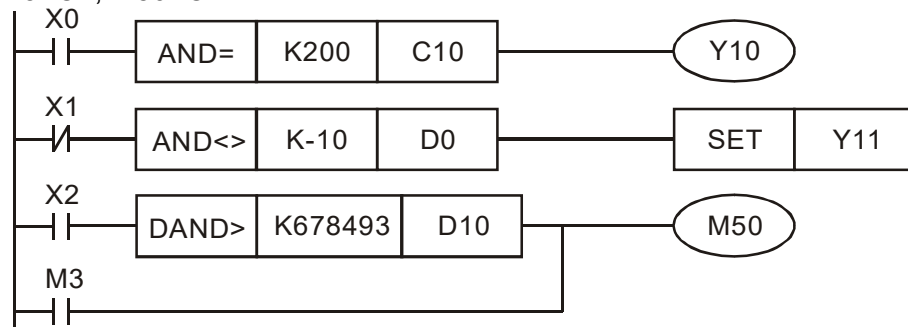

API 240~ 246	D	OR※	(S1)	(S2)	Contact form compare OR*									
Bit device			Word device								16-bit command (5 STEP)			
X	Y	M	K	H	KnX	KnY	KnM	T	C	D	OR※	Continuous execution type	—	—
S1			*	*	*	*	*	*	*	*				
S2			*	*	*	*	*	*	*	*				
Notes on operand usage: ※ : = , > , < , <> , ≤ , ≥											32-bit command (9 STEP)			
Please refer to the function specifications table for each device in series for the scope of device usage											DOR※	Continuous execution type	—	—
Flag signal: none														

- Explanation**
- **S₁**: data source device 1. **S₂**: data source device 2.
 - This command compares the content of **S₁** and **S₂**. Taking API 240 (OR=) as an example, when the result of comparison is equal, this command will be activated; when the result of comparison is unequal, this command will not be activated.
 - The OR* command is a compare command in parallel with a contact.

API No.	16-bit commands	32-bit commands	Conditions for activation	Conditions for inactivation
240	OR=	DOR=	S₁ = S₂	S₁ ≠ S₂
241	OR>	DOR>	S₁ > S₂	S₁ ≤ S₂
242	OR<	DOR<	S₁ < S₂	S₁ ≥ S₂
244	OR<>	DOR<>	S₁ ≠ S₂	S₁ = S₂
245	OR≤	DOR≤	S₁ ≤ S₂	S₁ > S₂
246	OR≥	DOR≥	S₁ ≥ S₂	S₁ < S₂

- Example**
- When X0=On and the current value of C10 is also equal to K200, Y10=On.
 - When X1=Off and the content of register D0 is not equal to K-10, Y11=On and remains in that state.
 - When X2 =On and the content of the 32-bit register D0(D11) is less than 678,493, or M3=On, M50=On.

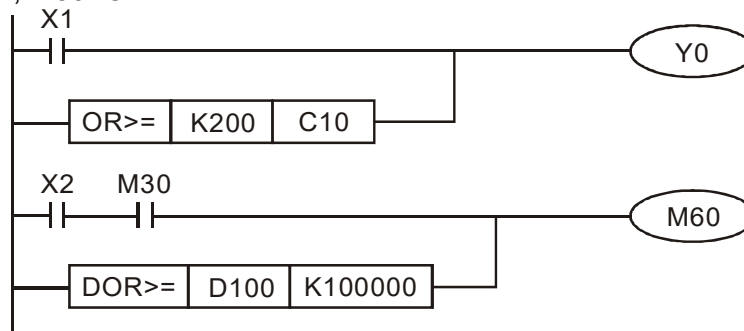

API 275~ 280	FLD*		(S1) (S2)		Floating point number contact form compare LD*								
Bit device			Word device									16-bit command	
X	Y	M	K	H	KnX	KnY	KnM	T	C	D	-		
S1								*	*	*	-		
S2								*	*	*	-		
Notes on operand usage: # : & · \ ^											FLD* : Continuous execution type		
Please refer to the function specifications table for each device in series for the scope of device usage											Flag signal: none		

Explanation

- ◆ **S₁**: data source device 1. **S₂**: data source device 2.
- ◆ This command compares the content of **S₁** and **S₂**. Taking "FLD=" as an example, if the result of comparison is "equal," this command will be activated; but it will not be activated when the result is "unequal."
- ◆ The FLD* command can directly input floating point numerical values (for instance: F1.2) to the **S₁**, **S₂** operands, or store floating-point numbers in register D for use in operations.
- ◆ This command can be used while directly connected with the busbar

API No.	32-bit commands	Conditions for activation	Conditions for inactivation
275	FLD=	S₁ = S₂	S₁ ≠ S₂
276	FLD>	S₁ > S₂	S₁ ≤ S₂
277	FLD<	S₁ < S₂	S₁ ≥ S₂
278	FLD<>	S₁ ≠ S₂	S₁ = S₂
279	FLD≤	S₁ ≤ S₂	S₁ > S₂
280	FLD≥	S₁ ≥ S₂	S₁ < S₂

Example

- ◆ When the floating point number of register D200 (D201) is less than or equal to F1.2, and X1 activated, contact Y21 will be activated and remain in that state.

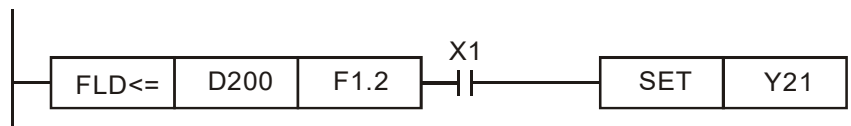

API 281~ 286	FAND※			(S1) (S2)			Floating point number contact form compare AND*							
Bit device			Word device									16-bit command		
X	Y	M	K	H	KnX	KnY	KnM	T	C	D	-			
S1								*	*	*	32-bit command (9 STEP)			
S2								*	*	*	FAND※ : Continuous execution type			
Notes on operand usage: # : & · · ^										Flag signal: none				
Please refer to the function specifications table for each device in series for the scope of device usage														

Explanation

- ◆ **S₁**: data source device 1. **S₂**: data source device 2.
- ◆ This command compares the content of **S₁** and **S₂**. Taking "FAND=" as an example, if the result of comparison is "equal," this command will be activated; but it will not be activated when the result is "unequal."
- ◆ The FAND* command can directly input floating point numerical values (for instance: F1.2) to the **S₁**, **S₂** operands, or store floating-point numbers in register D for use in operations.
- ◆ This command can be used while directly connected with the busbar

API No.	32-bit commands	Conditions for activation	Conditions for inactivation
281	FAND=	S₁ = S₂	S₁ ≠ S₂
282	FAND>	S₁ > S₂	S₁ ≤ S₂
283	FAND<	S₁ < S₂	S₁ ≥ S₂
284	FAND<>	S₁ ≠ S₂	S₁ = S₂
285	FAND<=	S₁ ≤ S₂	S₁ > S₂
286	FAND>=	S₁ ≥ S₂	S₁ < S₂

Example

- ◆ When X1=Off, and the floating point number in register D100 (D101) is not equal to F1.2, Y21=On and remains in that state.

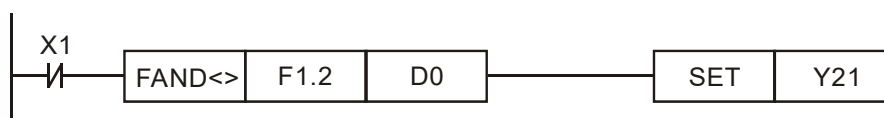

API 287~ 292	FOR*		(S1) (S2)		Floating point number contact form compare OR*								
Bit device			Word device									:16-bit command	
X	Y	M	K	H	KnX	KnY	KnM	T	C	D	-	-	
S1								*	*	*	-	-	
S2								*	*	*	:32-bit command (9 STEP)		
Notes on operand usage: # : & · \ ^											FOR* : Continuous execution type		
Please refer to the function specifications table for each device in series for the scope of device usage											Flag signal: none		

Explanation

- ◆ **S₁**: data source device 1. **S₂**: data source device 2.
- ◆ This command compares the content of **S₁** and **S₂**. Taking "FOR=" as an example, if the result of comparison is "equal," this command will be activated; but it will not be activated when the result is "unequal."
- ◆ The FOR* command can directly input floating point numerical values (for instance: F1.2) to the **S₁**, **S₂** operands, or store floating-point numbers in register D for use in operations.
- ◆ This command can be used while directly connected with the busbar

API No.	32-bit commands	Conditions for activation	Conditions for inactivation
287	FOR=	S₁ = S₂	S₁ ≠ S₂
288	FOR>	S₁ > S₂	S₁ ≤ S₂
289	FOR<	S₁ < S₂	S₁ ≥ S₂
290	FOR<>	S₁ ≠ S₂	S₁ = S₂
291	FOR≤	S₁ ≤ S₂	S₁ > S₂
292	FOR≥	S₁ ≥ S₂	S₁ < S₂

Example

- ◆ When X2 and M30 are both equal to "On," or the floating point number in register D100 (D101) is greater than or equal to F1.234, M60=On.

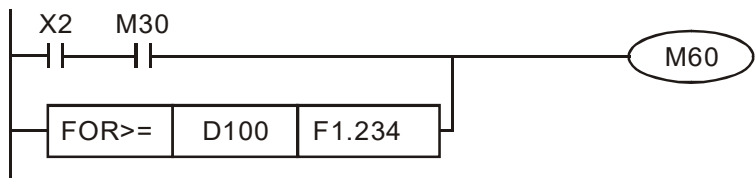

16-6-5 Detailed explanation of driver special applications commands

API 139	RPR	P	(S1) (S2)	Read servo parameter
------------	------------	---	-----------	----------------------

Bit device			Word device								16-bit command (5 STEP)			
X	Y	M	K	H	KnX	KnY	KnM	T	C	D	RPR	Continuous execution type	RPRP	Pulse execution type
S1			*	*							*			
S2											*			

Notes on operand usage: none

32-bit command

 Flag signal: none

Explanation ■ (S1): Parameter address of data to be read. (S2): Register where data to be read is stored.

API 140	WPR	P	(S1) (S2)	Write servo parameter
------------	------------	---	-----------	-----------------------

Bit device			Word device								16-bit command (5 STEP)			
X	Y	M	K	H	KnX	KnY	KnM	T	C	D	WPR	Continuous execution type	WPRP	Pulse execution type
S1			*	*							*			
S2			*	*							*			

Notes on operand usage: none

32-bit command

 Flag signal: none

Explanation ■ (S1): Data to write to specified page. (S2): Parameter address of data to be written.

- Example**
- When the data in the CFP2000 driver's parameter H01.00 is read and written to D0, data from H01.01 will be read and written to D1.
 - When M0=On, the content of D10 will be written to the C2000 driver parameter 04.00 (first speed of multiple speed levels).
 - When the parameter has been written successfully, M1017=On.
 - The CFP2000's WPR command does not support writing to the 20XX address, but the RPR command supports reading of 21XX, 22XX.

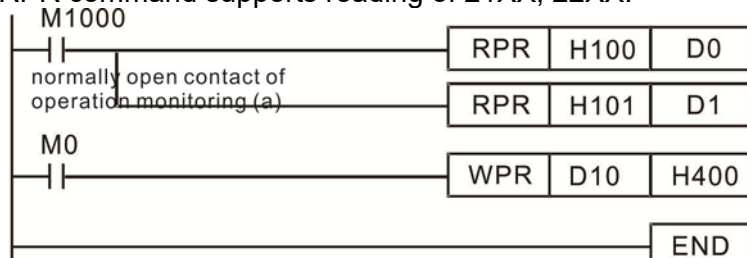

Recommendation Take care when using the WPR command. When writing parameters, because most parameters are recorded as they are written, these parameters may only be revised 10⁹ times; a memory write error may occur if parameters are written more than 10⁹ times.

Because the following commonly-used parameters have special processing, there are **no** restrictions on the number of times they may be written.

- P00-10: Control method
- P00-11: Speed mode selection
- P00-12: P2P position mode
- P00-13: Torque mode select
- P00-27: User-defined value
- P01-12: Acceleration time 1
- P01-13: Deceleration time 1

P01-14: Acceleration time 2

P01-15: Deceleration time 2

P01-16: Acceleration time 3

P01-17: Deceleration time 3

P01-18: Acceleration time 4

P01-19: Deceleration time 4

P02-12: Select MI Conversion Time mode:

P02-18: Select MO Conversion Time mode:

P04-50 ~ P04-69: PLC register parameter 0 - 19

P08-04: Upper limit of integral

P08-05: PID output upper limit

P10-17: Electronic gear A

P10-18: Electronic gear B

P11-34: Torque command

P11-43: P2P highest frequency

P11-44: Position control acceleration time

P11-45: Position control deceleration time

Calculation of the number of times written is based on whether the written value is modified. For instance, writing the same value 100 times at the same time counts as writing only once.

When writing a PLC program, if unsure of usage of the WPR command, we recommend that you use the WPRP command.

API 141	FPID		P	(S1) (S2) (S3) (S4)	Driver PID control mode									
Bit device			Word device								16-bit command (9 STEP)			
X	Y	M	K	H	KnX	KnY	KnM	T	C	D	FPID	Continuous execution type	FPIDP	Pulse execution type
S1			*	*						*	32-bit command			
S2			*	*						*				
S3			*	*						*				
S4			*	*						*				
Notes on operand usage: none											Flag signal: none			

- Explanation**
- (S1) : PID reference target value input terminal select. (S2) : PID function proportional gain P. (S3) : PID function integral time I. (S4) : PID function differential time D.
 - The FPID command can directly control the driver's feedback control of PID parameter 08-00 PID reference target value input terminal selection, 08-01 proposal gain P, 08-02 integral time I, and 08-03 differential time D.

- Example**
- When M0=On, the set PID reference target value input terminal selection is 0 (no PID function), the PID function proportional gain P is 0, the PID function integral time I is 1 (units: 0.01 sec.), and the PID function differential time D is 1 (units: 0.01 sec.).
 - When M1=On, the set PID reference target value input terminal selection is 0 (no PID function), the PID function proportional gain P is 1 (units: 0.01), the PID function integral time I is 0, and the PID function differential time D is 0.
 - When M2=On, the set PID reference target value input terminal selection is 1 (target frequency input is controlled from the digital keypad), the PID function proportional gain P is 1 (units: 0.01), the PID function integral time I is 0, and the PID function differential time D is 0.
 - D1027: Frequency command after PID operation.

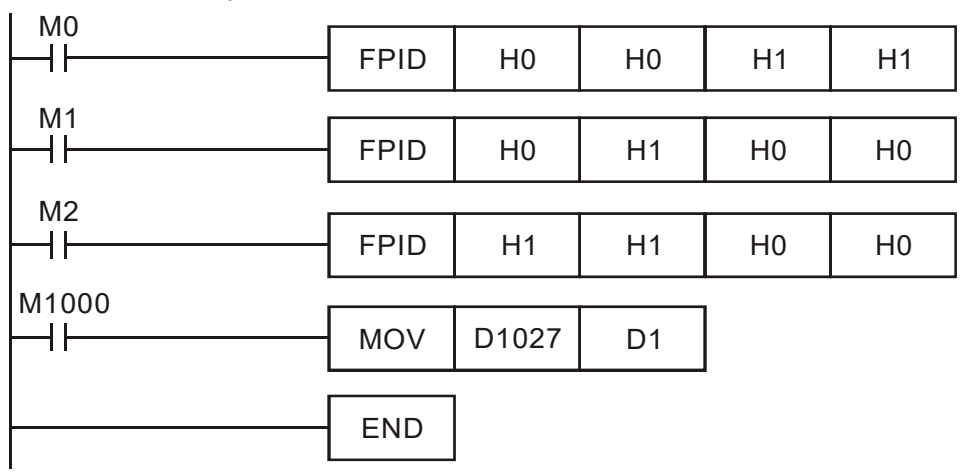

API 142	FREQ		P	(S1)	(S2)	(S3)	Driver speed control mode								
Bit device			Word device								16-bit command (7 STEP)				
	X	Y	M	K	H	KnX	KnY	KnM	T	C	D	FREQ	Continuous execution type	FREQP	Pulse execution type
S1				*	*						*				
S2				*	*						*				
S3				*	*						*				
Notes on operand usage: none												32-bit command			
												Flag signal: M1015			

- Explanation
- (S1): Frequency command. (S2): Acceleration time. (S3): Deceleration time
 - S2, S3: In acceleration/deceleration time settings, the number of decimal places is determined by the definitions of Pr01-45.

Example

When 01-45=0: units of 0.01 sec.

The setting of 50 for S2 (acceleration time) in the ladder diagram below implies 0.5 sec, and the S3 (deceleration time) setting of 60 implies 0.6 sec

- The FREQ command can control driver frequency commands, and acceleration and deceleration time; it also uses special register control actions, such as:
M1025: Control driver RUN(On)/STOP(Off) (RUN requires Servo On (M1040 On) to be effective)
M1026: Control driver operating direction FWD(Off)/REV(On)
M1040: Control Servo On/Servo Off.
M1042: Trigger quick stop (ON)/does not trigger quick stop (Off).
M1044: Pause (On)/release pause (Off)
M1052: Lock frequency (On)/release lock frequency (Off)

Example

- M1025: Driver RUN (On)/ STOP (Off), M1026: driver operating direction FWD (Off)/ REV (On). M1015: frequency reached.
- When M10=On, sets the driver frequency command K300(3.00Hz), with an acceleration/deceleration time of 0.
When M11=On, sets the driver frequency command K3000 (30.00Hz), with an acceleration time of 50 (0.5 sec.) and deceleration time of 60 (0.6 sec.). (When 01-45=0)
- When M11=Off, the driver frequency command will now change to 0

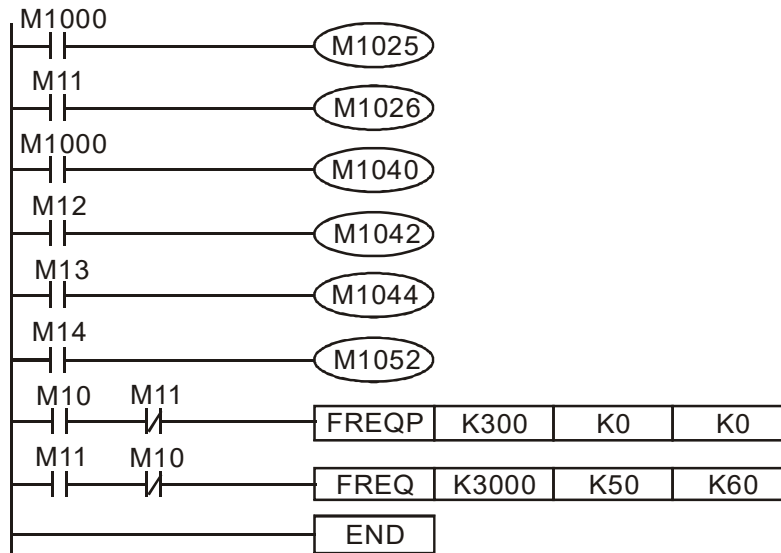

- Parameter 09-33 are defined on the basis of whether reference commands have been cleared before PLC operation
Bit 0 : Prior to PLC scanning procedures, whether the target frequency has been cleared is 0. (This will be written to the FREQ command when the PLC is On)

Bit 1 : Prior to PLC scanning procedures, whether the target torque has been cleared is 0. (This will be written to the TORQ command when the PLC is On)

Bit 2 : Prior to PLC scanning procedures, whether speed limits in the torque mode have been cleared is 0. (This will be written to the TORQ command when the PLC is On)

Example: When using r to write a program,

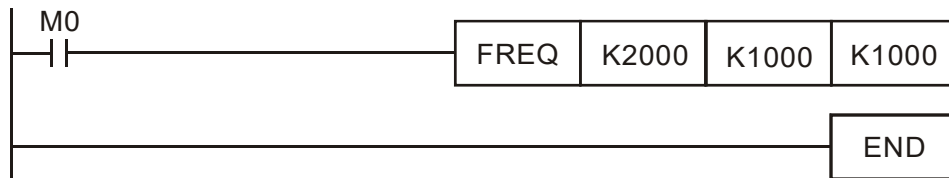

If we force M0 to be 1, the frequency command will be 20.00 Hz; but when M0 is set as 0, there will be a different situation.

Case 1: When the 09-33 bit 0 is 0, and M0 is set as 0, the frequency command will remain at 20.00Hz.

Case 2: When the 09-33 bit 0 is 1, and M0 is set as 0, the frequency command will change to 0.00Hz

The reason for this is that when the 09-33 bit 0 is 1 prior to PLC scanning procedures, the frequency will first revert to 0.

When the 09-33 bit 0 is 0, the frequency will not revert to 0.

API 261	CANRX		P	(S1)	(S2)	(S3)	(D)	Read CANopen slave station data							
	Bit device			Word device							16-bit command (9 STEP)				
	X	Y	M	K	H	KnX	KnY	KnM	T	C	D	CANRX	Continuous execution type	CANRXP	Pulse execution type
S1				*	*										
S2				*	*										
S3				*	*										
D									*	*	*				
Notes on operand usage: none												32-bit command			
												Flag signal			

Explanation ■ (S1): Slave station number. (S2): Main index. (S3): Subindex+bit length.
(D): Preset address.

- The CANRX command can read the index of the corresponding slave station. When it is executed, it will send the SDO message format to the slave station. M1066 and M1067 will both be 0 at that time, and M1066 will be set as 1 after reading. If the slave station gives the correct response, it will write the value to the preset register, and set M1067 as 1. If the slave station has a response error, M1067 will be set as 0, and an error message will be recorded to D1076 to D1079.

Example

M1002: When the PLC runs, the command will be triggered once and will set K4M400 = K1

Afterwards, each time M1066 is 1, it will switch to a different message.

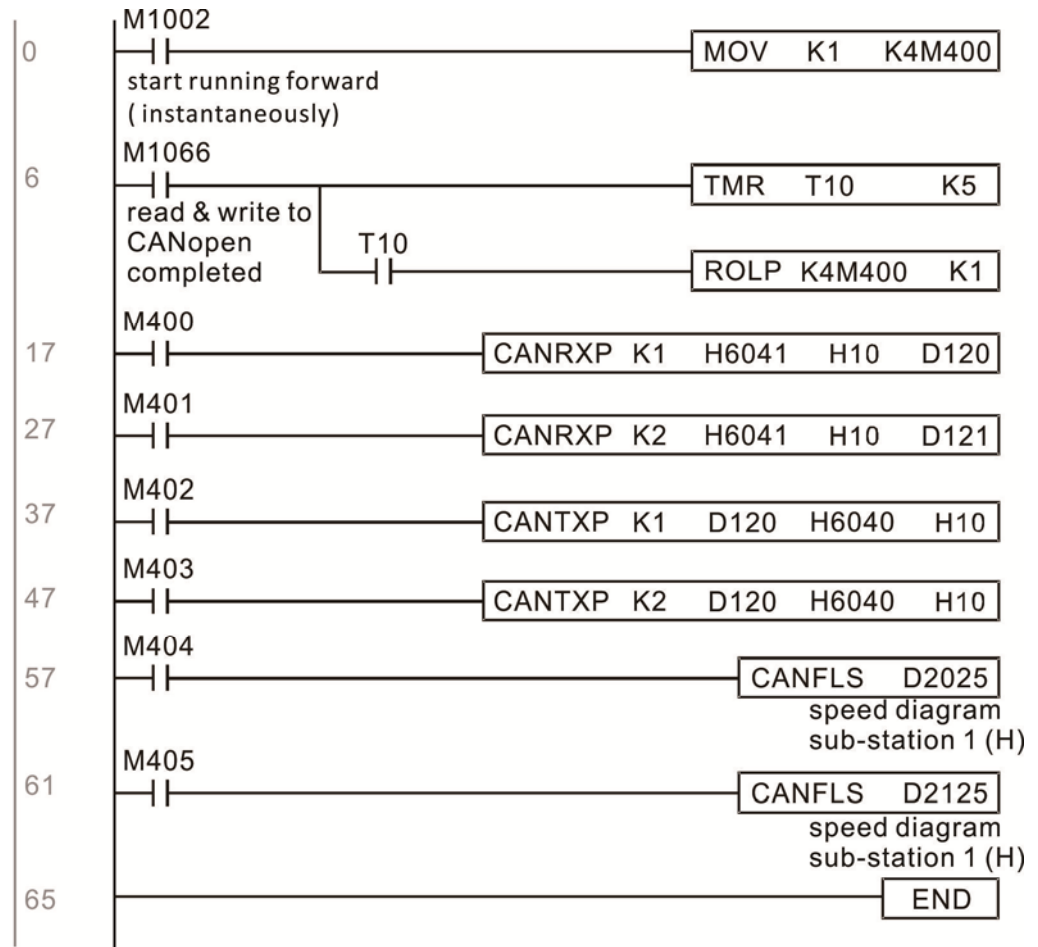

API 264	CANTX	P	(S1) (S2) (S3) (S4)	Write CANopen slave station data										
Bit device		Word device										16-bit command (9 STEP)		
X	Y	M	K	H	KnX	KnY	KnM	T	C	D	CANTX	Continuous execution type	CANTXP	Pulse execution type
S1			*	*										
S2			*	*				*	*	*				
S3			*	*							32-bit command			
S4			*	*										
Notes on operand usage: none											Flag signal			

- Explanation
- (S1): Slave station number. (S2): Address to be written. (S3): Main index. (S4): Subindex+bit length.
 - The CANTX command can write a value to the index of the corresponding slave station. When it is executed, it will send the SDO message format to the slave station. M1066 and M1067 will both be 0 at that time, and M1066 will be set as 1 after reading. If the slave station gives the correct response, it will write the value to the preset register, and set M1067 as 1. If the slave station has a response error, M1067 will be set as 0, and an error message will be recorded to D1076 to D1079.

API 265	CANFLS	P	(D)	Refresh special D corresponding to CANopen										
Bit device		Word device										16-bit command (3 STEP)		
X	Y	M	K	H	KnX	KnY	KnM	T	C	D	CANFLS	Continuous execution type	CANFLSP	Pulse execution type
D			*	*										
Notes on operand usage: none											32-bit command			
											Flag signal			

- Explanation
- (D): Special D to be refreshed.
 - The CANFLS command can refresh special D commands. When is a read only attribute, executing this command will send a message equivalent to that of CANRX to the slave station, and the number of the slave station will be transmitted back and refreshed to this special D. When there is a read/write attribute, executing this command will send a message equivalent to that of CANTX to the slave station, and the value of this special D will be written to the corresponding slave station.
 - When M1066 and M1067 are both 0, and M1066 is set as 1 after reading, if the slave station gives a correct response, the value will be written to the designated register, and M1067 will be set as 1. If the slave station's response contains an error, then M1067 will be set as 0, and an error message will be recorded to D1076~D1079.

API 320	ICOMR	P	(S1) (S2) (S3) (D)	Internal communications read										
Bit device		Word device										16-bit command (9 STEP)		
X	Y	M	K	H	KnX	KnY	KnM	T	C	D	ICOMR	Continuous execution type	ICOMRP	Pulse execution type
S1			*	*						*				
S2			*	*						*				
S3			*	*						*	32-bit command (17 STEP)			
D			*	*						*	DICOMR	Continuous execution type	DICOMRP	Pulse execution type
Notes on operand usage: none											Flag signal: M1077 M1078 M1079			

- Explanation
- (S1): Selection of slave device. (S2): Device selection (0: converter, 1: internal PLC). (S3): Read address. (D): Saving target.
 - The ICOMR command can obtain the slave station's converter and the internal PLC's register value.

API 321	D	ICOMW	P	(S1) (S2) (S3) (D)	Internal communications write							
Bit device		Word device							16-bit command (9 STEP)			
X	Y	M	K	H	KnX	KnY	KnM	T	C	D	ICOMW: Continuous execution type	ICOMWP: Pulse execution type
S1			*	*						*	32-bit command (17 STEP)	
S2			*	*						*	DICOMW: Continuous execution type	DICOMWP: Pulse execution type
S3			*	*						*		
D			*	*						*		
Notes on operand usage: none											Flag signal: M1077 M1078 M1079	

Explanation

- (S1): Selection of slave device. (S2): Device selection (0: converter, 1: internal PLC). (S3): Read address. (D): Saving target.
- The ICOMW command write a value to the slave station's converter and the internal PLC's register.

Example

Please refer to the following example:

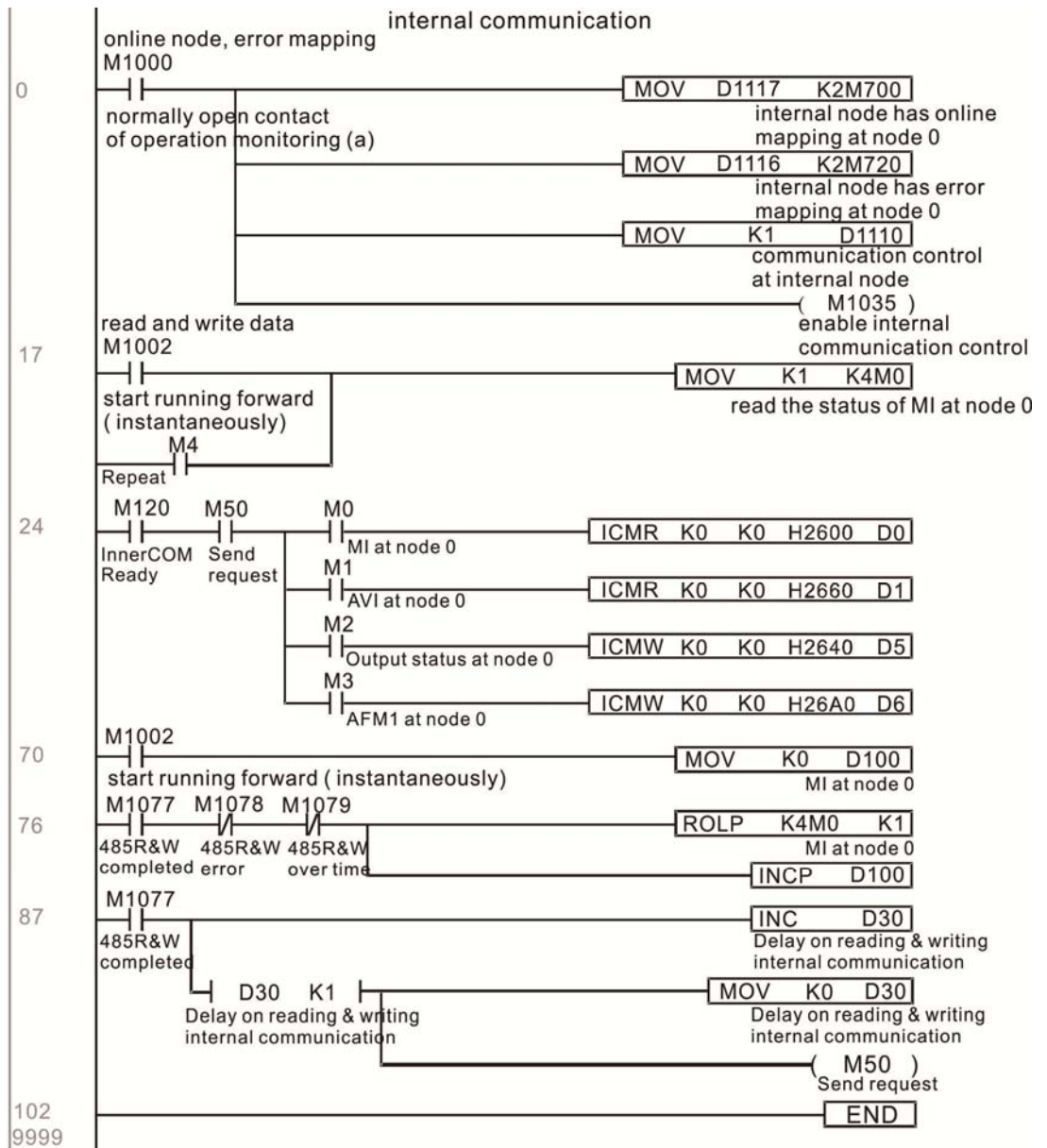

16-7 Error display and handling

Code	ID	Descript	Recommended handling approach
PLrA	47	RTC time check	Turn power on and off when resetting the keypad time
PLrt	49	(incorrect RTC mode)	Turn power on and off after making sure that the keypad is securely connected
PLod	50	Data writing memory error	Check whether the program has an error and download the program again
PLSv	51	Data write memory error during program execution	Restart power and download the program again
PLdA	52	Program transmission error	Try uploading again; if the error persists, sent to the manufacturer for service
PLFn	53	Command error while downloading program	Check whether the program has an error and download the program again
PLor	54	Program exceeds memory capacity or no program	Restart power and download the program again
PLFF	55	Command error during program execution	Check whether the program has an error and download the program again
PLSn	56	Check code error	Check whether the program has an error and download the program again
PLEd	57	Program has no END stop command	Check whether the program has an error and download the program again
PLCr	58	MC command has been used continuously more than nine times	Check whether the program has an error and download the program again
PLdF	59	Download program error	Check whether the program has an error and download again
PLSF	60	PLC scan time excessively long	Check whether the program code has a writing error and download again

16-8 CANopen Master control applications

Control of a simple multi-axis application is required in certain situations. If the device supports the CANopen protocol, a CFP2000 can serve as the master in implementing simple control (speed control). The setting method comprises the following seven steps:

Step 1: Activating CANopen Master functions

1. Parameter 09-45=1 (initiates Master functions); restart power after completing setting, the status bar on the KPC-CC02 digital keypad will display "CAN Master".
2. Parameter 00-02=6 reset PLC (please note that this action will reset the program and PLC registers to the default values)
3. Turn power off and on again.
4. Use the KPC-CC02 digital keypad to set the PLC control mode as "**PLC Stop**" (if a newly-introduced driver is used, the blank internal PLC program will cause a PLFF warning code to be issued).

Step 2: Master memory settings

1. After connecting the 485 communications cable, use WPL Soft to set the PLC **status** as Stop (if the PLC mode has been switched to the "**PLC Stop**" mode, the PLC **status** should already be Stop)
2. Set the address and corresponding station number of the slave station to be controlled. For instance, if it is wished to control two slave stations (a maximum of 8 stations can be controlled simultaneously), and the station numbers are 21 and 22, it is only necessary to set D2000 and D2100 as 20 and 21, and then set D2200, D2300, D2400, D2500, D2600, and D2700 as 0. The setting method involves use of the PLC's WPL editing software WPL as follows:
 - Open WPL and implement **communications > register edit (T C D)** function

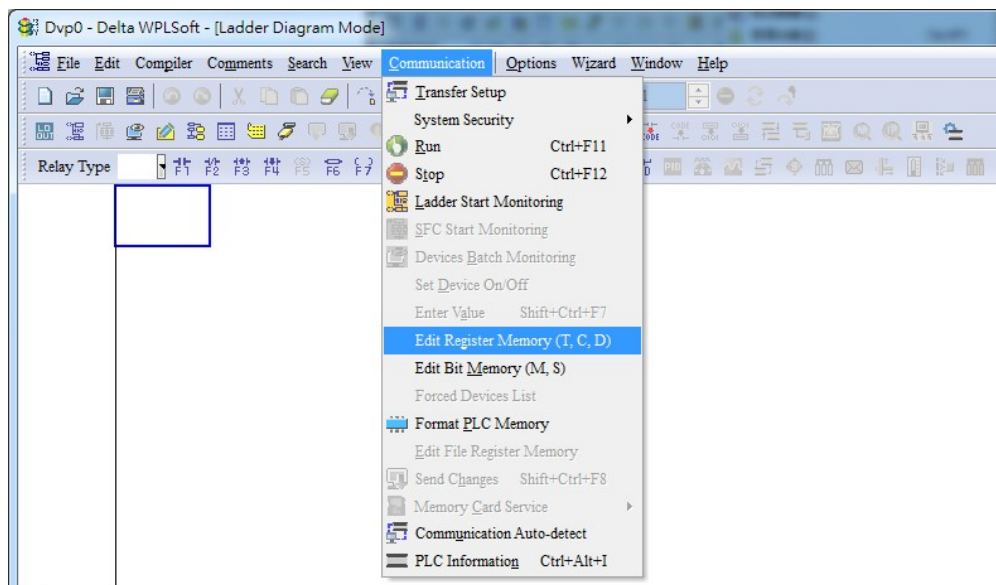

- After leaving the PLC register window, the register setting screen will appear, as shown below:

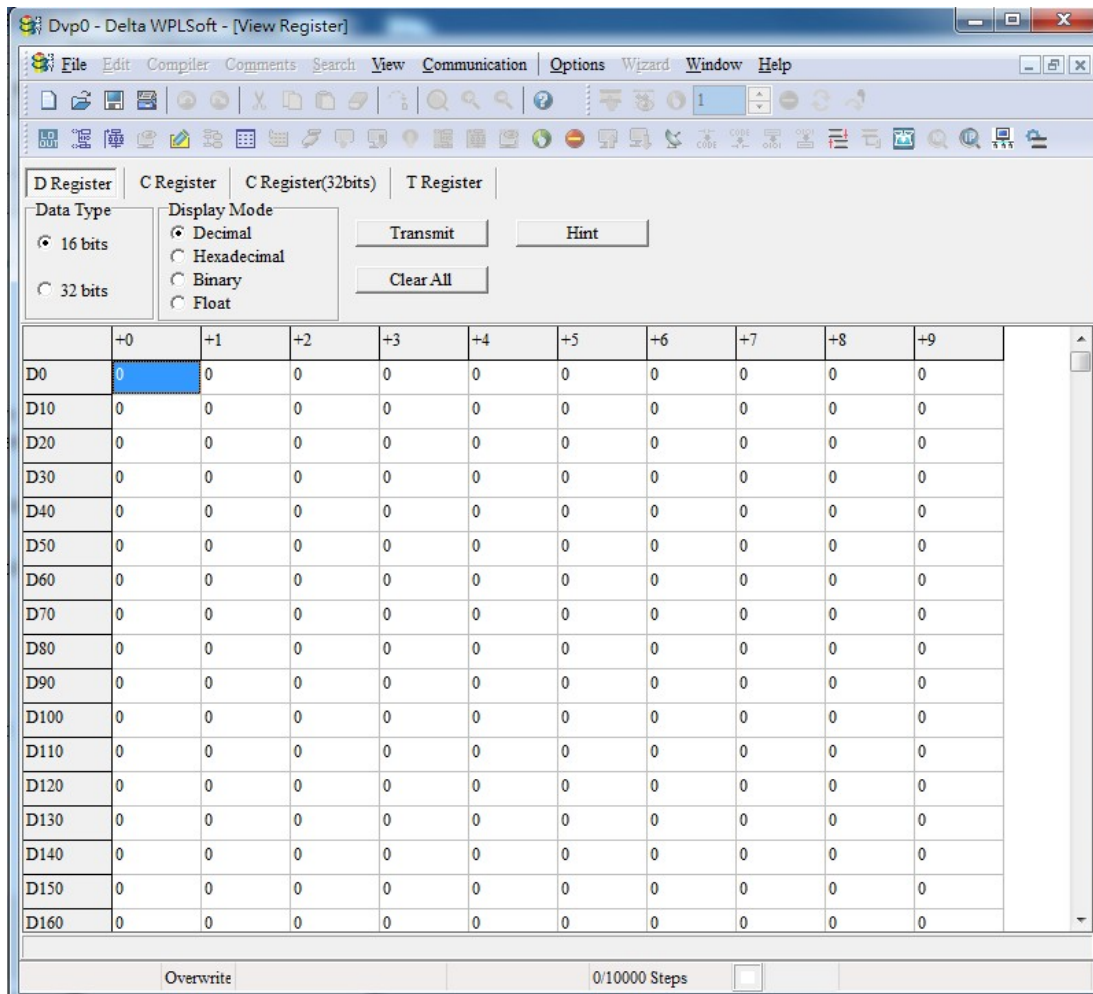

If there is a new PLC program and no settings have yet been made, you can read default data from the converter, and merely edit it to suit the current application. If settings have already been made, however, the special D in the CANopen area will display the saved status (the CANopen D area is located at D1090 to D1099 and D2000 to D2799). Assuming it is a new program, we will first read the default data from the converter; check the communications format if there is no communications link (the default PLC station number is 2, 9600, 7N2, ASCII). Perform the following steps: 1. Switch the PLC to Stop status; 2. Press the transmit button; 3. click on read memory after exiting the window; 4. Ignore D0-D399; and 5. click on the confirm button.)

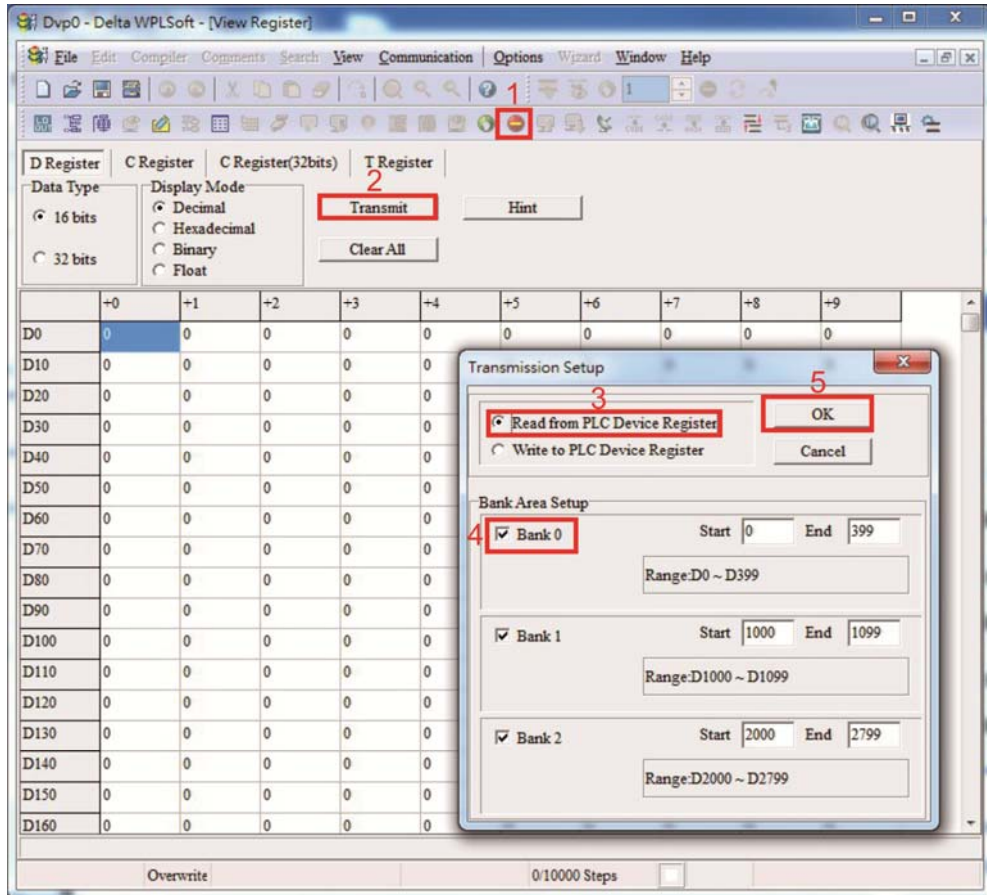

After reading the data, it is necessary to perform some special D settings. Before proceeding, we will first introduce the special D implications and setting range. The CANopen Master's special D range is currently D1070 to D1099 and D2000 to D2799; this range is divided into 3 blocks:

The first block is used to display CANopen's current status, and has a range of D1070 to D1089; the second block is used for CANopen's basic settings, and has a range of D1090 to D1099; the third block is the slave station mapping and control area, and has a range of D2000 to D2799;

These areas are therefore introduced as follows:

The first contains the current CANopen status display:

When the master initializes a slave station, we can find out from D1070 whether configuration of the slave device has been completed; we can find out whether an error occurred in the configuration process from D1071 and whether the configuration is inappropriate from D1074.

After entering normal control, we can find out whether the slave device is offline from D1073. In addition, we can check the slave device's read/write information using the CANRX, CANTX, and CANFLS commands; error information can be obtained from D1076 to D1079 if there has been a read/write failure.

Special D	Description of Function	R/W
D1070	Channel opened by CANopen initialization (bit0=Machine code0	R
D1071	Error channel occurring in CANopen initialization process (bit0=Machine code0	R
D1072	Reserved	-
D1073	CANopen break channel (bit0=Machine code0	R

Special D	Description of Function	R/W
D1074	Error code of master error 0: No error 1: Slave station setting error 2: Synchronizing cycle setting error (too small)	R
D1075	Reserved	-
D1076	SDO error message (main index value)	R
D1077	SDO error message (secondary index value)	R
D1078	SDO error message (error code L)	R
D1079	SDO error message (error code H)	R

The second area is for basic CANopen settings: (the PLC must have **stopped** when this area is used to make settings)

We must set the information exchange time for the master and slave station,

Special D	Description of Function	Default:	R/W
D1090	Synchronizing cycle setting	4	RW

Use D1090 to perform settings; setting time relationships include:

$$\text{Sync time} \geq \frac{1M}{\text{Rate}} * \frac{N}{4}$$

N: TXPDO + RXPDO

For instance, when communications speed is 500Kbps, TXPDO + RXPDO have 8 sets, and synchronizing time will require more than 4 ms

We must also define how many slave stations will be open. D1091 is the channel for defining station opening, and D2000+100*n is the station number defining this channel. See the detailed explanation below.

Slave station number n=0-7

Special D	Description of Function	R/W
D1091	Sets slave station On or Off (bit 0-bit 7 correspond to slave stations number 0-7)	RW
D2000+100*n	Slave station number	RW

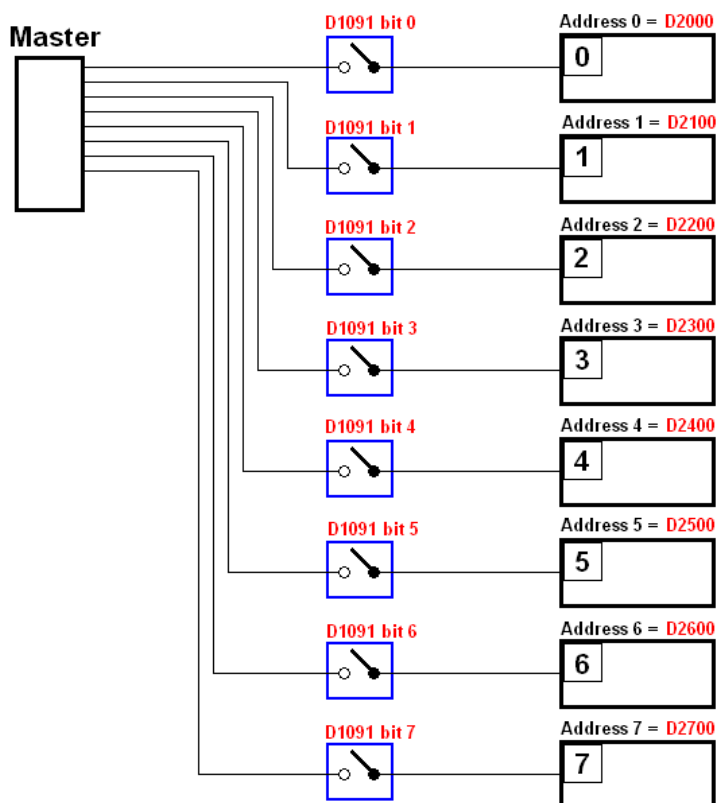

If slave devices have a slow start-up, the master can delay for a short time before performing slave station configuration; this time delay can be set via D1092.

Special D	Description of Function	Default:	R/W
D1092	Delay before start of initialization	0	RW

With regard to slave device initialization, a delay time can be set to judge whether failure has occurred. If the communications speed is relatively slow, the delay time can be adjusted to judge whether initialization has been completed, which will ensure that there is time to perform slave device initialization.

Special D	Description of Function	Default:	R/W
D1099	Initialization completion delay time Setting range: 1 to 60000 sec	15 sec.	RW

After communication is successful, the system must detect whether there is a break in communications with the slave station. D1093 is used to set detection time, and D1094 sets the number of consecutive errors that will trigger a break error.

Special D	Description of Function	Default:	R/W
D1093	Break time detection	1000ms	RW
D1094	Break number detection	3	RW

The packet type transmitted by PDO is set before establishing normal communications and generally does not require adjustment.

Special D	Description of Function	Default:	R/W
D1097	Corresponding real-time transmission type (PDO) Setting range: 1~240	1	RW
D1098	Corresponding real-time receiving type (PDO) Setting range: 1~240	1	RW

The third block is the slave station mapping and control area.

CANopen provides a PDO method to perform mapping of the master and slave station memory, and enables the master to directly access read/write data in a certain memory area. The master will automatically perform data exchange with the corresponding slave device, and the read/write values can be seen directly from the special D area after real-time exchange (M1034 = 1 time) has been established. The CFP2000 currently supports real-time mapping of four PDOs, and there are two types of PDO RXPDO (reads slave device information) and TXPDO (writes to slave device). In addition, in order to facilitate control, the CFP2000 cannot perform mapping of commonly-used registers; the following is an overview of the current PDO mapping situation:

TX PDO							
PDO4 (Torque)		PDO3 (Position)		PDO2 (Remote I/O)		PDO1 (Speed)	
Description	Special D	Description	Special D	Description	Special D	Description	Special D
Controller word	D2008+100*n	Controller word	D2008+100*n	Slave device DO	D2027+100*n	Controller word	D2008+100*n
Target torque	D2017+100*n	Target position	D2020+100*n D2021+100*n	Slave device AO1	D2031+100*n	Target speed	D2012+100*n
Control mode	D2010+100*n	Control mode	D2010+100*n	Slave device AO2	D2032+100*n		
				Slave device AO3	D2033+100*n		

RXPDO							
PDO4 (Torque)		PDO3 (Position)		PDO2 (Remote I/O)		PDO1 (Speed)	
Description	Special D	Description	Special D	Description	Special D	Description	Special D
Mode word	D2009+100*n	Mode word	D2009+100*n	Slave device DI	D2026+100*n	Mode word	D2009+100*n
Actual torque	D2018+100*n	Actual position	D2022+100*n D2023+100*n	Slave device AI1	D2028+100*n	Actual frequency	D2013+100*n
Actual mode	D2011+100*n	Actual mode	D2011+100*n	Slave device AI2	D2029+100*n		
				Slave device AI3	D2030+100*n		

Because usage requires only simple to open the corresponding PDO, where TXPDO employs D2034+100*n settings and RXPDO employs D2067+100*n settings.

These two special D areas are defined as follows:

	PDO4		PDO3		PDO2		PDO1	
Default definition	Torque		Position		Remote I/O		Speed	
bit	15	14 ~ 12	11	10 ~ 8	7	6 ~ 4	3	2 ~ 0
Definition	En	Length:	En	Length:	En	Length:	En	Length:

En: indicates whether PDO is used

Length: indicates mapping of several variables

In a simple example, if we wish to control a C2000 slave device and cause it to operate in speed mode, we only have to make the following settings:

D2034+100*n =000Ah

Length	TX PDO							
	PDO4		PDO3		PDO2		PDO1	
	Description	Special D	Description	Special D	Description	Special D	Description	Special D
1	Controller word	D2008+100*n	Controller word	D2008+100*n	Slave device DO	D2027+100*n	Controller word	D2008+100*n
2	Target torque	D2017+100*n	Target position	D2020+100*n D2021+100*n	Slave device AO1	D2031+100*n	Target speed	D2012+100*n
3	Control mode	D2010+100*n	Control mode	D2010+100*n	Slave device AO2	D2032+100*n		
4					Slave device AO3	D2033+100*n		

	PDO4		PDO3		PDO2		PDO1	
Definition	Torque		Position		Remote I/O		Speed	
bit	15	14 ~ 12	11	10 ~ 8	7	6 ~ 4	3	2 ~ 0
Definition	0	0	0	0	0	0	1	2

D2067+100*n =000Ah

Length	TX PDO							
	PDO4		PDO3		PDO2		PDO1	
	Description	Special D	Description	Special D	Description	Special D	Description	Special D
1	Controller word	D2009+100*n	Controller word	D2009+100*n	Slave device DI	D2026+100*n	Controller word	D2009+100*n
2	Actual torque	D2018+100*n	Actual position	D2022+100*n D2023+100*n	Slave device AI1	D2028+100*n	Actual frequency	D2013+100*n
3	Actual mode	D2011+100*n	Actual mode	D2011+100*n	Slave device AI2	D2029+100*n		
4					Slave device AI3	D2030+100*n		

	PDO4		PDO3		PDO2		PDO1	
Definition	Torque		Position		Remote I/O		Speed	
bit	15	14 ~ 12	11	10 ~ 8	7	6 ~ 4	3	2 ~ 0
Definition	0	0	0	0	0	0	1	2

Switch the PLC to Run after completing settings. Now wait for successful initialization of CANopen (M1059 = 1 and M1061 = 0), and then initiate CANopen memory mapping (M1034 = 1). The control word and frequency command will now automatically refresh to the corresponding slave

device (D2008+n*100 and D2012+n*100), and the slave device's status word and currently frequency will also be automatically sent back to the master station (D2009+n*100 and D2013+n*100). This also illustrates how the master can handle these tasks through read/write operations in the special D area.

Furthermore, it should be noted that the remote I/O of PDO2 can obtain the slave device's current DI and AI status, and can also control the slave device's DO and AO status. Nevertheless, after introducing a fully automatic mapping special D, the CFP2000 CANopen master also provides additional information refreshes. For instance, while in speed mode, acceleration/deceleration settings may have been refreshed. The special D therefore also stores some seldom-used real-time information, and these commands can be refreshed using the CANFLS command. The following is the CFP2000's current CANopen master data conversion area, which has a range of D2001+100*n - D2033+100*n, as shown below:

1. The range of n is 0-7
2. ●Indicates PDOTX, ▲Indicates PDORX; unmarked special D can be refreshed using the CANFLS command

Special D	Description of Function	Default :	PDO Default:				R/W
			1	2	3	4	
D2000+100*n	Station number n of slave station Setting range: 0~127 0: No CANopen function	0					RW
D2002+100*n	Manufacturer code of slave station number n (L)	0					R
D2003+100*n	Manufacturer code of slave station number n (H)	0					R
D2004+100*n	Manufacturer's product code of slave station number n (L)	0					R
D2005+100*n	Manufacturer's product code of slave station number n (H)	0					R

Basic definitions

Special D	Description of Function	Default:	PDO Default:				R/W
			1	2	3	4	
D2006+100*n	Communications break handling method of slave station number n	0					RW
D2007+100*n	Error code of slave station number n error	0					R
D2008+100*n	Control word of slave station number n	0	●		●	●	RW
D2009+100*n	Status word of slave station number n	0	▲		▲	▲	R
D2010+100*n	Control mode of slave station number n	2					RW
D2011+100*n	Actual mode of slave station number n	2					R

Velocity Control

Special D	Description of Function	Default :	PDO Default:				R/W
			1	2	3	4	
D2001+100*n	Torque restriction on slave station number n	0					RW
D2012+100*n	Target speed of slave station number n (rpm)	0	●				RW
D2013+100*n	Actual speed of slave station number n (rpm)	0	▲				R
D2014+100*n	Error speed of slave station number n (rpm)	0					R

Special D	Description of Function	Default	PDO Default:				R/W
			1	2	3	4	
D2015+100*n	Acceleration time of slave station number n (ms)	1000					RW
D2016+100*n	Deceleration time of slave station number n (ms)	1000					RW

Remote I/O

Special D	Description of Function	Default:	PDO Default:				R/W
			1	2	3	4	
D2026+100*n	MI status of slave station number n	0		▲			R
D2027+100*n	MO setting of slave station number n	0		●			RW
D2028+100*n	AI1 status of slave station number n	0		▲			R
D2029+100*n	AI2 status of slave station number n	0		▲			R
D2030+100*n	AI3 status of slave station number n	0		▲			R
D2031+100*n	AO1 setting of slave station number n	0		●			RW
D2032+100*n	AO2 setting of slave station number n	0		●			RW
D2033+100*n	AO3 setting of slave station number n	0		●			RW

After gaining an understanding of special D definitions, we return to setting steps. After entering the values corresponding to D1090 to D1099, D2000+100*n, D2034+100*n and D2067+100*n, we cannot begin to perform downloading, which is performed in accordance with the following steps: (1. D2000 and D2100 are set as 20 and 21, and D2200, D2300, D2400, D2500, D2600, and D2700 are set as 0; if a setting of 0 causes problems, D1091 can be set as 3, and slave stations 2 to 7 can be closed. 2. Switch PLC to Stop status. 3. Press the transmit button. 4. click on write memory after exiting the window. 5. Ignore D0-D399. 6. Change the second range to D1090-D1099. 7. Click on Confirm.)

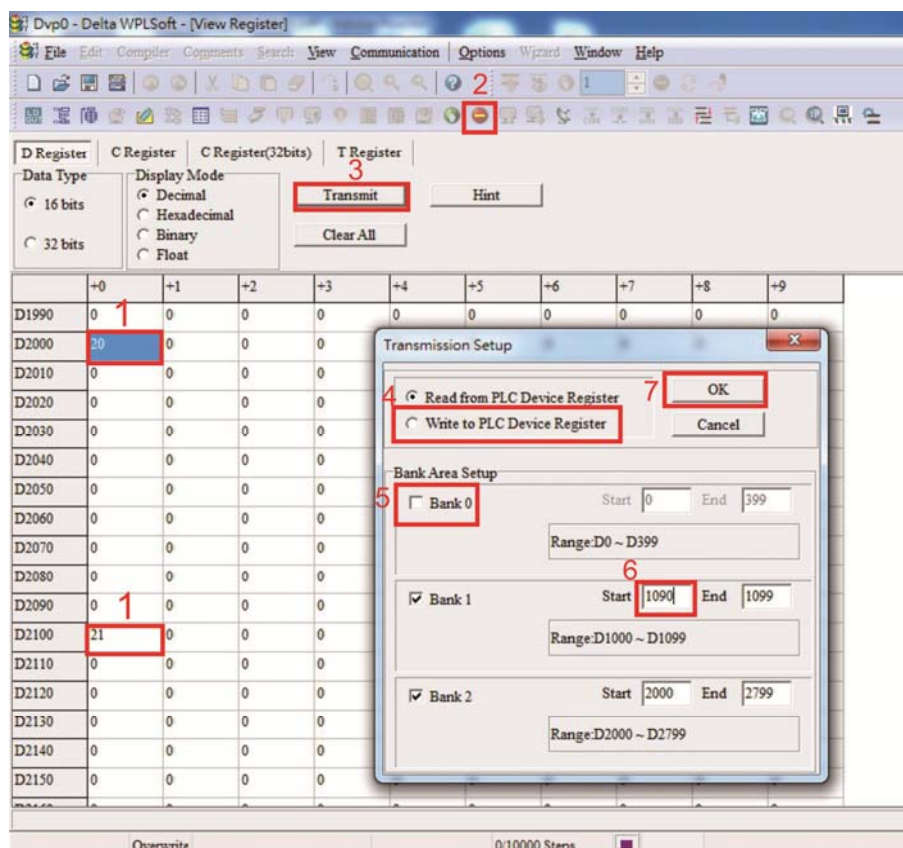

- Another method can be used to set D1091: Determine which of slave stations 0 to 7 will not be needed, and set the corresponding bits to 0. For instance, if it is not necessary to control slave stations 2, 6 and 7, merely set D1091 = 003B, and the setting method is the same as described above: Use WPL to initiate **communications > use register edit (T C D)** function to perform settings.

Step 3: Set the master's communications station number and communications speed

- ☑ When setting the master's station number (parameter 09-46, default is set as 100), make sure not to use the same number as a slave station.
- ☑ Set the CANopen communications speed (parameter 09-37); regardless of whether the driver is defined as a master or slave station, the communications speed is set via this parameter.

Step 4: Write program code

Real-time access: Can directly read/write to or from the corresponding D area.

Non real-time access:

Read command: Use the CANRX command for reading. M1066 will be 1 when reading is complete; M1067 will be 1 if reading is successful, and M1067 will be 0 if an error has occurred.

Write command: Use the CANTX command for writing. M1066 will be 1 when writing is complete; M1067 will be 1 if writing is successful, and M1067 will be 0 if an error has occurred.

Refresh command: Use CANFLS command to refresh (if there are RW attributes, the master will write to the slave station; if there are RO attributes, the slave station will return the read values to the master); M1066 will be 1 if refresh has been completed; M1067 will be 1 if refresh is successful, and M1067 will be 0 if an error has occurred.

NOTE

When using CANRX, CANTX or CANFLS, internal implementation commands will wait until M1066 is completed before executing the next CANRX, CANTX or CANFLS.

Afterwards, download program to the driver (Please note that the PLC's default communications format is ASCII 7N2 9600, and the station number is 2. The WPL must therefore be modified, and the WPL setting pathway is **settings > communications settings**)

Step 5: Set the slave stations' station numbers, communications speed, control source, and command source

Delta's CFP2000 and EC series devices currently support the CANopen communications interface driver, and the corresponding slave station numbers and communications speed parameters are as follows:

	Corresponding device parameters		Value	Definition
	C2000	E-C		
Slave station address	09-36	09-20	0	Disable CANopen hardware interface
			1~127	CANopen Communication address

	Corresponding device parameters		Value	Definition
	C2000	E-C		
Communication speed	09-37	09-21	0	1M
			1	500K
			2	250K
			3	125K
			4	100K
			5	50K
Control source	00-21	-	3	
	-	02-01	5	
Frequency source	00-20	-	6	
	-	02-00	5	
Torque source	11-33	-	3	
	-	-	-	
Position source	11-40	-	3	
	-	-	-	

Delta's A2 Servo currently supports the CANopen communications interface, and the corresponding slave station numbers and communications speed parameters are as follows:

	Corresponding device parameters		Value	Definition
	A2			
Slave station address	03-00		1~127	CANopen Communication address
Communication speed	03-01 bit 8-11 XRXX		R= 0	125K
			R= 1	250K
			R= 2	500K
			R= 3	750K
			R= 4	1M
Control/command source	01-01		B	

Step 6: Connect hardware wiring

When performing wiring, note the head and tail terminal resistance; connection methods are as follows:

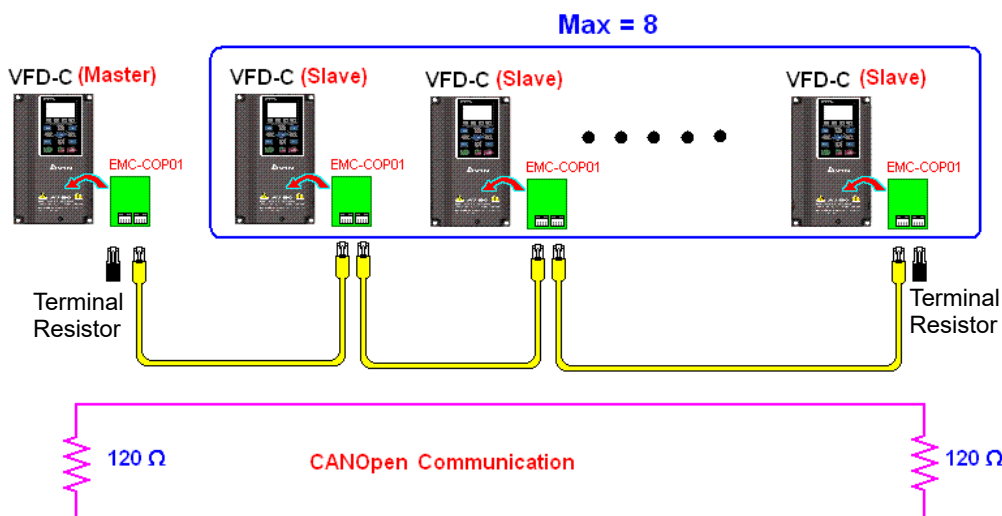

Step 7: Initiate control

After a program has been written and downloaded, switch the PLC mode to Run. Merely turn power to master and slave stations off and then on again.

Refer to CANMasterTest 1 vs. 2 driver.dvp

Example

CFP2000 driver one-to-two control

Step 1: Activating CANopen Master functions

- ☑ Parameter 09-45=1 (initiates Master functions); restart power after completing setting, the status bar on the KPC-CC02 digital keypad will display "CAN Master".
- ☑ Parameter 00-02=6 reset PLC (please note that this action will reset the program and PLC registers to the default values)
- ☑ Turn power off and on again.
- ☑ Use the KPC-CC02 digital keypad to set the PLC control mode as "PLC Stop" (if a newly-introduced driver is used, the blank internal PLC program will cause a PLFF warning code to be issued).

Step 2: Master memory correspondences

- ☑ Enable WPL
- ☑ Use keypad set PLC mode as Stop (PLC 2)
- ☑ WPL read D1070 to D1099 D2000 to D2799
- ☑ Set D2000=10 D2100=11
- ☑ Set D2100 2200 2300 2400 2500 2600 2700=0
- ☑ Download D2000 to D2799 settings

Step 3: Set the master's communications station number and communications speed

- ☑ When setting the master's station number (parameter 09-46, default is set as 100), make sure not to use the same number as a slave station.
- ☑ Set the CANopen communications speed as 1M (parameter 09-37=0); regardless of whether the driver is defined as a master or slave station, the communications speed is set via this parameter.

Step 4: Write program code

Real-time access: Can directly read/write to or from the corresponding D area.

Non real-time access:

Read command: Use the CANRX command for reading. M1066 will be 1 when reading is complete; M1067 will be 1 if reading is successful, and M1067 will be 0 if an error has occurred.

Write command: Use the CANTX command for writing. M1066 will be 1 when writing is complete; M1067 will be 1 if writing is successful, and M1067 will be 0 if an error has occurred.

Refresh command: Use CANFLS command to refresh (if there are RW attributes, the master will write to the slave station; if there are RO attributes, the slave station will return the read values to the master); M1066 will be 1 if refresh has been completed; M1067 will be 1 if refresh is successful, and M1067 will be 0 if an error has occurred.

NOTE

When using CANRX, CANTX or CANFLS, internal implementation commands will wait until M1066 is completed before executing the next CANRX, CANTX or CANFLS.

Afterwards, download program to the driver (Please note that the PLC's default communications format is ASCII 7N2 9600, and the station number is 2. The WPL must therefore be modified, and the WPL setting pathway is **settings > communications settings**)

Step 5: Set the slave stations' station numbers and communications speed

Slave station no. 1: 09-37 = 0(Speed 1M) 09-36=10(Node ID 10)

Slave station no. 2: 09-37 = 0(Speed 1M) 09-36=10(Node ID 11)

Step 6: Connect hardware wiring

When performing wiring, note the head and tail terminal resistance; connection methods are as follows:

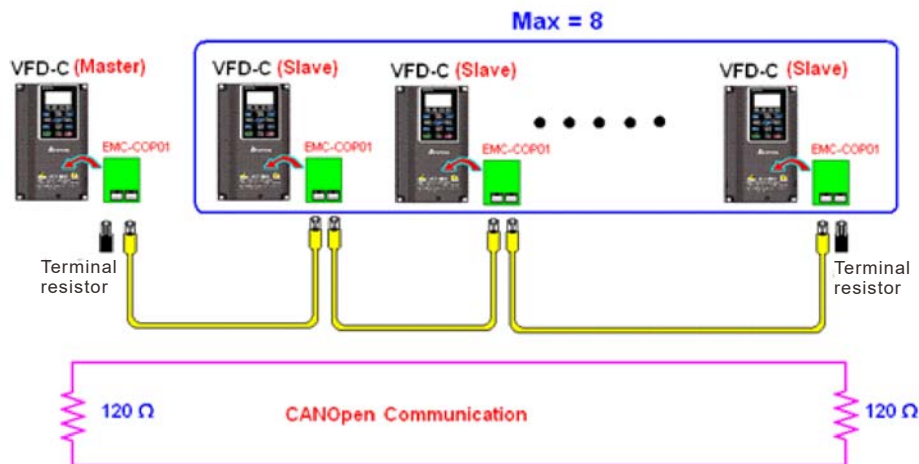

Step 7: Initiate control

After a program has been written and downloaded, switch the PLC mode to Run. Merely turn power to master and slave stations off and then on again.

Refer to CANMasterTest 1 vs. 2 driver.dvp

16-9 Explanation of various PLC speed mode controls

Speed mode supports SVC control. Under the speed mode of SVC control, it cannot be performed successfully unless finish motor parameter auto tuning ahead of time.

Control methods and settings are explained as follows:

Speed control:

Register table for speed mode:

Control special M

Special M	Description of Function	Attributes
M1025	Driver frequency = set frequency (ON)/driver frequency =0 (OFF)	RW
M1026	Driver operating direction FWD(OFF)/REV(ON)	RW
M1040	Hardware power (Servo On)	RW
M1042	Quick stop	RW
M1044	Pause (Halt)	RW
M1052	Lock frequency (lock, frequency locked at the current operating frequency)	RW

Status special M

Special M	Description of Function	Attributes
M1015	Frequency attained (when used together with M1025)	RO
M1056	Servo On Ready	RO
M1058	On Quick Stopping	RO

Control special D

Special D	Description of Function	Attributes
D1060	Mode setting (speed mode is 0)	RW

Status special D

Special D	Description of Function	Attributes
D1037	Converter output frequency (0.00~600.00)	RO
D1050	Actual operating mode (speed mode is 0)	RO

Speed mode control commands:

FREQ(P) S1 S2 S3

Target speed The first acceleration time setting The first deceleration time setting

Example of speed mode control:

Before performing speed control, if the FOC (magnetic field orientation) control method is used, setting of electromechanical parameters must first be completed.

1. Setting D1060 = 0 will shift the converter to the speed mode (default).
2. Use the FREQ command to control frequency, acceleration time, and deceleration time.
3. Set M1040 = 1, the driver will now be excited, but the frequency will be 0.
4. Set M1025 = 1, the driver frequency command will now jump to the frequency designated

16-10 Internal communications main node control

The protocol has been developed in order to facilitate the use of 485 instead of CANopen in certain application situations. The 485 protocol offers similar real-time characteristics as CANopen; this protocol can only be used on the CP2000, CFP2000 and CT2000 devices. The maximum number of slave devices is 8.

Internal communications have a master-slave structure. The initiation method is very simple:

Slave device:

Set parameter 09-31 = -1 to -8 in order to access 8 nodes, and set parameter 00-20 = 1 to define the control source as 485 and access the reference sources that must be controlled, namely speed command (00-21 = 2). This will complete slave device settings. (PLC functions do not need to be activated)

System

Setting the master is even simpler; it is only necessary to set parameter 09-31 = -10, and enable the PLC.

Hardware wiring: The master and slave stations are connected via the 485 serial port. The CFP2000 provides two types of 485 serial port interfaces, see the figure below: (please refer to 06 Control terminals concerning detailed terminal connections)

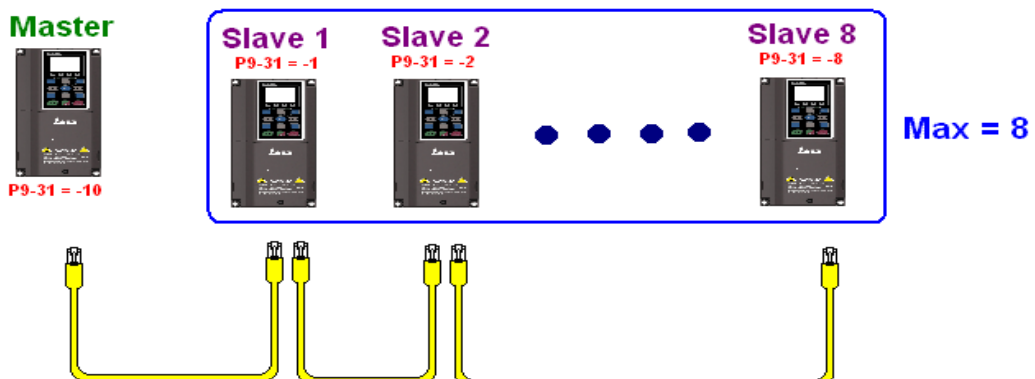
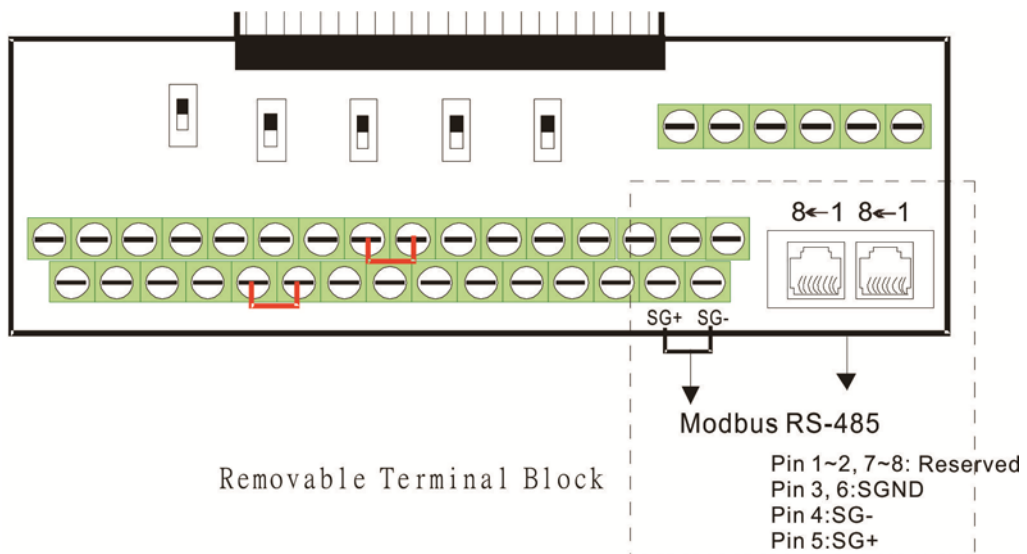

Master programming: In a program, D1110 can be used to define a slave station to be controlled (1-8, if set as 0, can jump between 8 stations). Afterwards, M1035 is set as 1, and the memory positions of the master and slave stations will correspond. At this time, it is only necessary to send commands to the correlation slave station address to control that station. The following is a register table connected with internal communications:

Control special M

Special M	Description of Function	Attributes
M1035	Initiates internal communications control	RW

Control special D

Special D	Description of Function	Attributes
D1110	Internal node communications number 1-8 (set the station number of the slave station to be controlled)	RW

Special D	Description of Function					Attributes
	Definition	bit	User rights	Speed mode	Homing mode	
D1120 + 10*N	Internal node N control command	0	4	Command functions	Homing Origin	RW
		1	4	Reverse rotation requirements	-	
		2	4	-	-	
		3	3	Temporary pause	-	
		4	4	Frequency locking	Temporary pause	
		5	4	JOG	-	
		6	2	Quick Stop	Quick Stop	
		7	1	Servo ON	Servo ON	
		11~8	4	Speed interval switching	-	
		13~12	4	Deceleration time change	-	
		14	4	Enable Bit 13 ~ 8	-	
	15	4	Clear error code	Clear error code		
D1121 + 10*N	Internal node N control mode			0	3	RW
D1122 + 10*N	Internal node N reference command L			Speed command (no number)	-	RW
D1123 + 10*N	Internal node N reference command H			-	-	RW

※ N = 0 ~ 7

Status special D

Special D	Description of Function	Attributes
D1115	Internal node synchronizing cycle (ms)	RO
D1116	Internal node error (bit0 = slave device 1, bit1 = slave device 2,...bit7 = slave device 8)	RO
D1117	Internal node online correspondence (bit0 = slave device 1, bit1 = slave device 2,...bit7 = slave device 8)	RO

Special D	Description of Function					Attributes
	bit	Speed mode	Location mode	Torque mode	Homing mode	
D1126 + 10*N	0	Frequency command arrival	Position command attained	Torque command attained	Zero command completed	RO
	1	Clockwise	Clockwise	Clockwise	Clockwise	
		Counterclockwise:	Counterclockwise:	Counterclockwise:	Counterclockwise:	
	2	Warning	Warning	Warning	Warning	
	3	Error	Error	Error	Error	
	5	JOG				
	6	Quick Stop	Quick Stop	Quick Stop	Quick Stop	
7	Servo ON	Servo ON	Servo ON	Servo ON		
D1127 + 10*N		Actual frequency	Actual position (with numbers)	Actual torque (with numbers)	-	RO
D1128 + 10*N		-		-	-	

※ N = 0 ~ 7

Example: Assume it is desired to control slave station 1 operation at frequencies of 30.00Hz and 60.00 Hz, status, and online node correspondences:

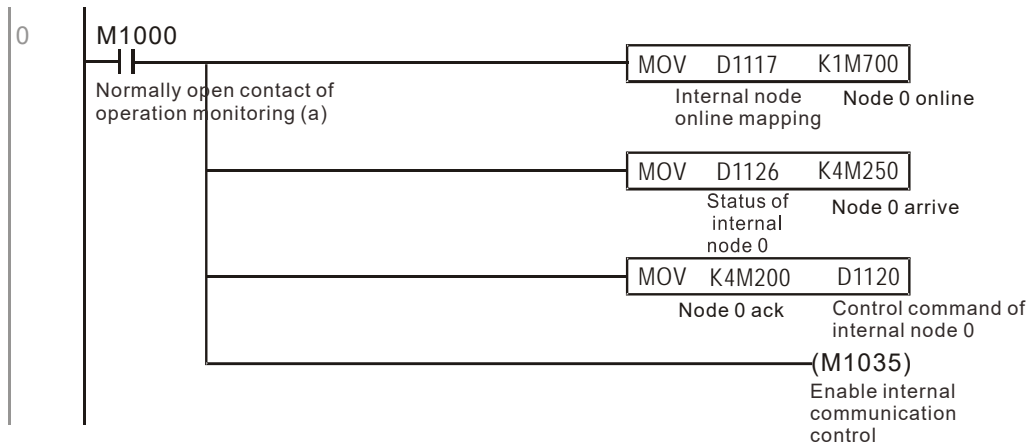

When it is judged that slave station 1 is online, delay 3 sec. and begin control

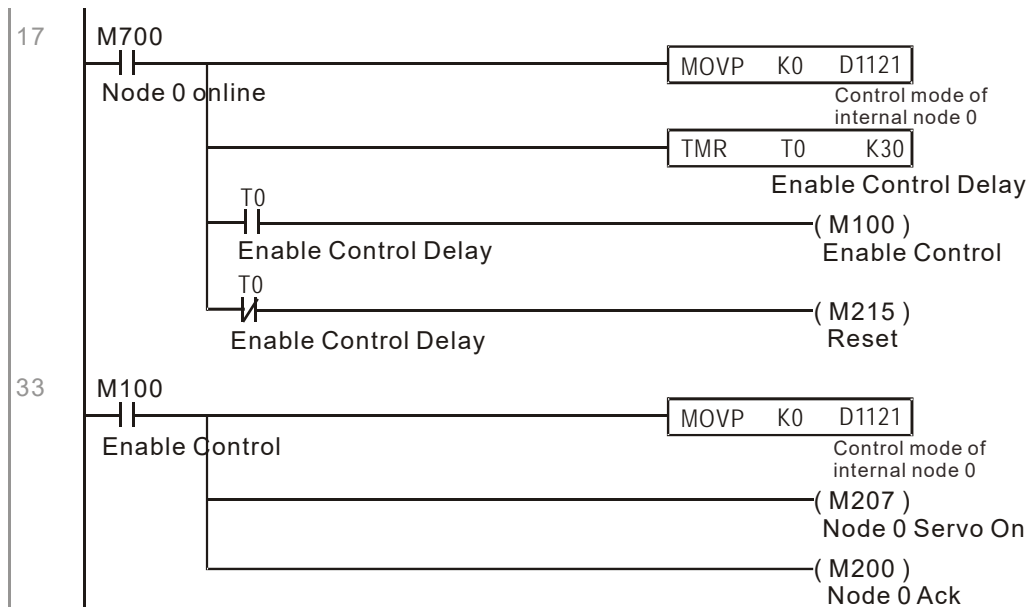

It is required slave station 1 maintain forward rotation at 30.00Hz for 1 sec., and maintain reverse rotation at 60.00 Hz for 1 sec., and repeat this cycle continuously.

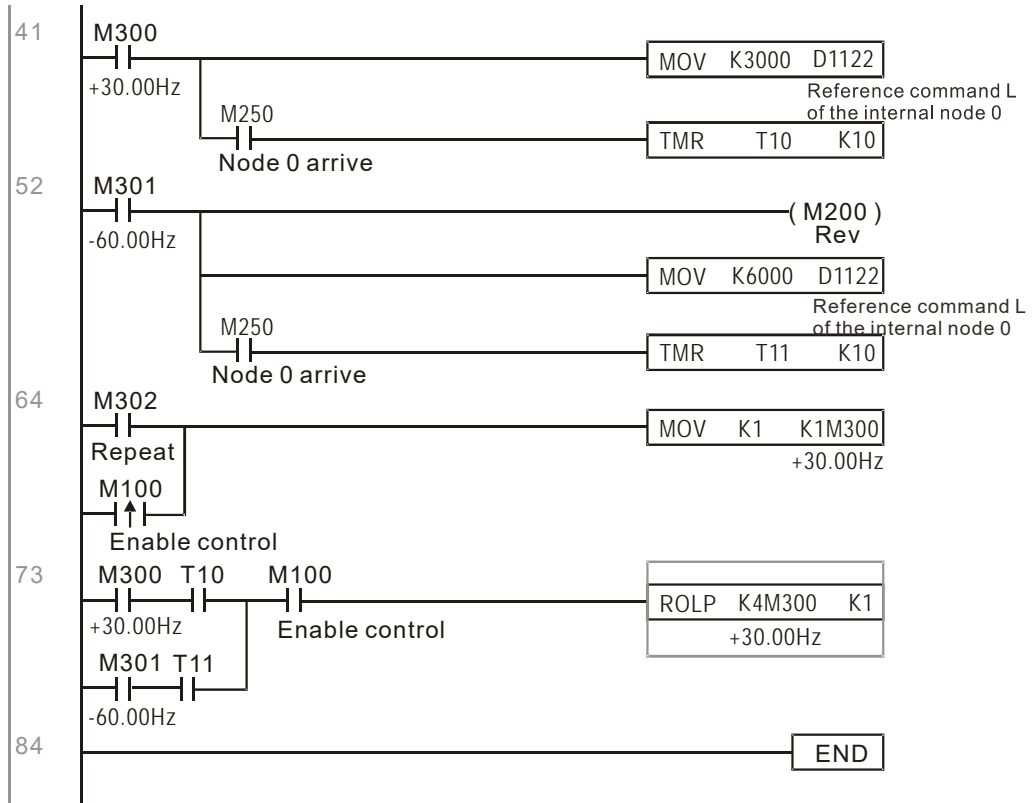

16-11 Modbus Remote IO Control Applications (use MODRW)

The CFP2000's internal PLC supports 485 read/write functions, which can be realized using the MODRW command. However, the 485 serial port must be defined as available for the PLC's 485 use before writing a program, and the parameter 09-31 must be set as -12. After completing settings, the standard functions defined by 485 can be used to implement read/write commands at other stations. Communications speed is defined by parameter 09-01, the communications format is defined by parameter 09-04, and the PLC's current station number is defined by parameter 09-35. The CFP2000 currently supports the functions read coil (0x01), read input (0x02), read register (0x03), write to single register (0x06), write to several coils (0x0F), and write to several registers (0x10). Explanations and the usage of these functions are provided as follows:

MODRW command					General meaning	Slave device is Delta's PLC meaning	Slave device is Delta's converter meaning
S1	S2	S3	S4	S5			
Node ID	Command	Address	Return: D area	Length :			
K3	H01	H500	D0	K18	Read coil (Bit)	Read 18 bits of data corresponding to slave station 3 PLC Y0 to Y21. This data is stored by bit 0 to 15 of the this station's D0 and bit 0 to bit 3 of D1.	Does not support this function
K3	H02	H400	D10	K10	Read input (Bit)	Read 10 bits of data corresponding to slave station 3 PLC X0 to X11. This data is stored by bit 0 to 9 of this station's D10.	Does not support this function
K3	H03	H600	D20	K3	Read register (word)	Read 3 words of data corresponding to slave station 3 PLC T0 to T2. This data is stored by D20 to D22.	Read 3 words of data corresponding to slave station 3 converter parameters 06-00 to 06-02. This data is stored by D20 to D22
K3	H06	H610	D30	XX	Write to single register (word)	Write slave station 3 PLC's T16 to this station's D30 value	Write slave station 3 converter 06 to 16 parameter to this station's D30 value
K3	H0F	H509	D40	K10	Write to multiple coils (Bit)	Write slave station 3 PLC's Y11 to Y22 to bit 0 to 9 of D40.	Does not support this function
K3	H10	H602	D50	K4	Write to multiple registers (word)	Write slave station 3 PLC's T2 to T5 to D50 to D53	Write slave station 3 converter 06-02 to 06-05 parameters to this station's D50 to D53

※ XX indicates doesn't matter

After implementing MODRW, the status will be displayed in M1077 (485 read/write complete), M1078 (485 read/write error), and M1079 (485 read/write time out). M1077 is defined so as to immediately revert to 0 after the MODRW command has been implemented. However, any of three situations—a report of no error, a data error report, or time out with no report—will cause the status of M1077 to change to On.

Example program: Testing of various functions

At the start, it will cause the transmitted time sequence to switch to the first data unit.

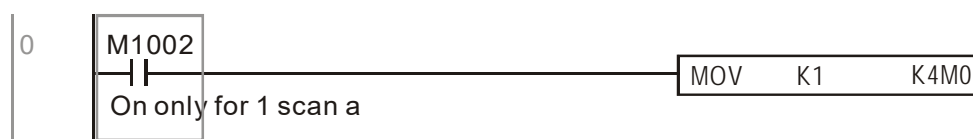

When the reported message indicates no error, it will switch to the next transmitted command



If time out occurs or an error is reported, the M1077 will change to On. At this time, after a delay of 30 scanning cycles, it will re-issue the original command once

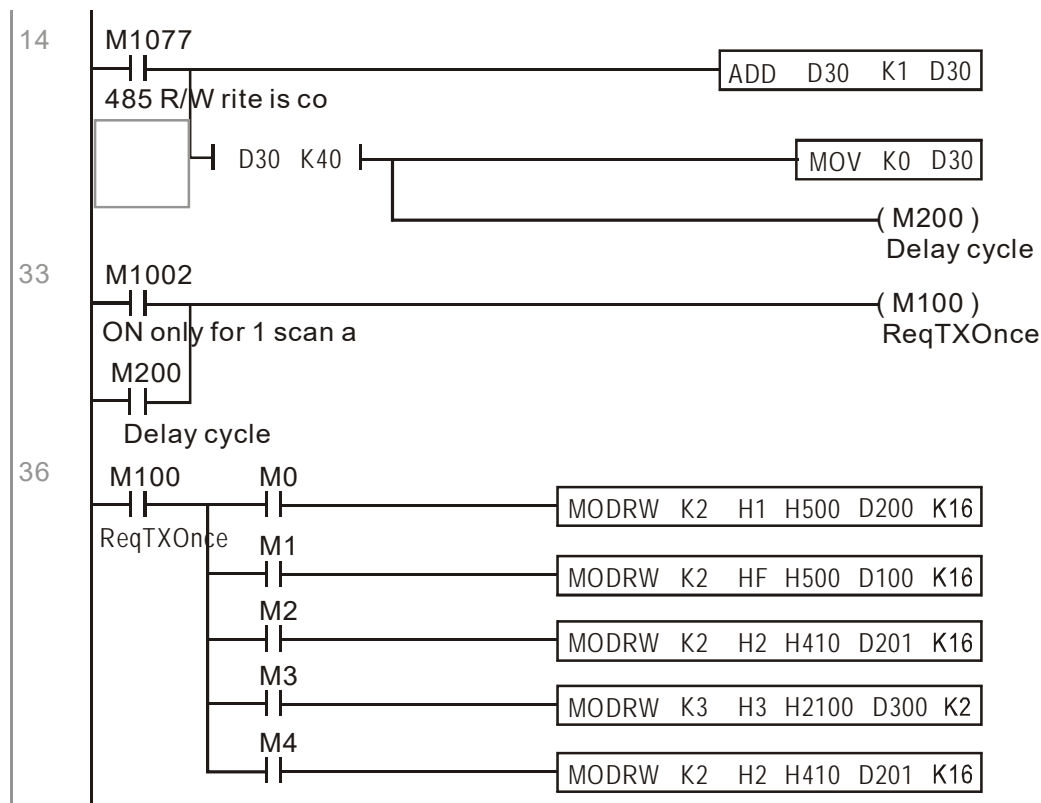

It will repeat after sending all commands

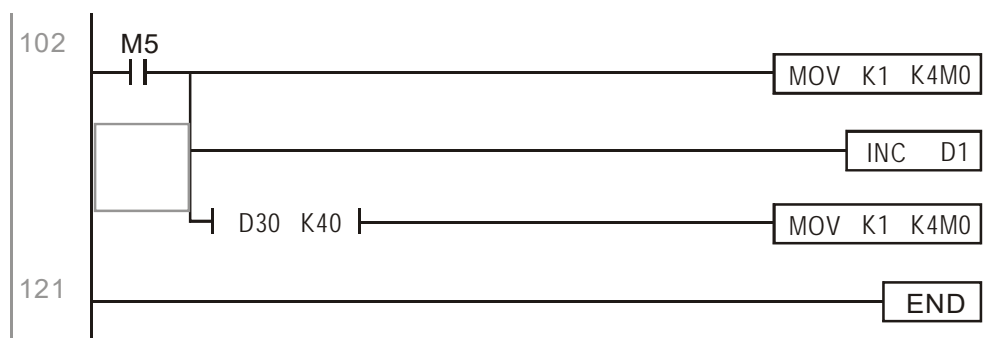

Practical applications:

Actual use to control the RTU-485 module.

Step 1: Set the communications format. Assume that the communications format is 115200, 8,N,2, RTU

C2000 : The default PLC station number is set as 2 (09-35)

09-31=-12(COM1 is controlled by the PLC), 09-01=115.2(The communications speed is 115200)

09-04=13(The format is 8,N,2, RTU)

RTU485: The station number = 8 (give example)

ID7	ID6	ID5	ID4	ID3	ID2	ID1	ID0
0	0	0	0	1	0	0	0

PA3	PA2	PA1	PA0	DR2	DR1	DR0	A/R
1	0	0	0	1	1	1	0

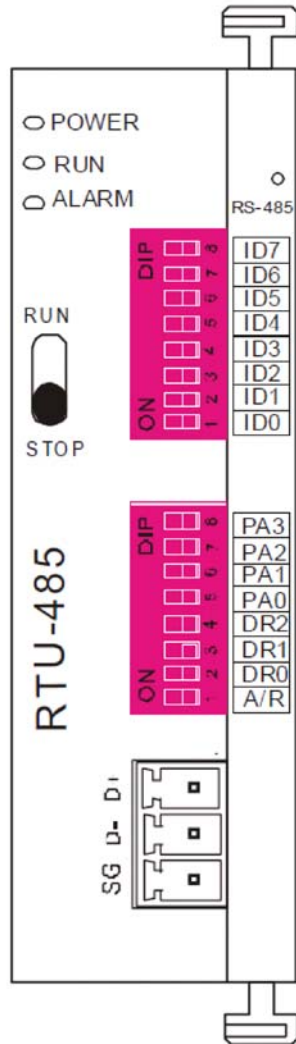

Communication station #:
ID0~ ID7 are defined as $2^0, 2^1, 2^2 \dots 2^6, 2^7$

Communication protocol

PA3	PA2	PA1	PA0	A/R	Communication Protocol
OFF	OFF	OFF	OFF	ON	7,E,1 · ASCII
OFF	OFF	OFF	ON	ON	7,O,1 · ASCII
OFF	OFF	ON	OFF	ON	7,E,2 · ASCII
OFF	OFF	ON	ON	ON	7,O,2 · ASCII
OFF	ON	OFF	OFF	ON	7,N,2 · ASCII
OFF	ON	OFF	ON	ON	8,E,1 · ASCII
OFF	ON	ON	OFF	ON	8,O,1 · ASCII
OFF	ON	ON	ON	ON	8,N,1 · ASCII
ON	OFF	OFF	OFF	ON	8,N,2 · ASCII
OFF	ON	OFF	ON	OFF	8,E,1 · RTU
OFF	ON	ON	OFF	OFF	8,O,1 · RTU
OFF	ON	ON	ON	OFF	8,N,1 · RTU
ON	OFF	OFF	OFF	OFF	8,N,2 · RTU

DR2	DR1	DR0	Communication Speed
OFF	OFF	OFF	1,200 bps
OFF	OFF	ON	2,400 bps
OFF	ON	OFF	4,800 bps
OFF	ON	ON	9,600 bps
ON	OFF	OFF	19,200 bps
ON	OFF	ON	38,400 bps
ON	ON	OFF	57,600 bps
ON	ON	ON	115,200 bps

Step 2: Install control equipment. We sequentially connect a DVP16-SP (8 IN 8 OUT), DVP-04AD (4 channels AD), DVP02DA (2 channels DA), and DVP-08ST (8 switches) to the RTU485.

The following corresponding locations can be obtained from the RTU485's configuration definitions:

Module	Terminals	485 Address
DVP16-SP	X0 ~ X7	0400H ~ 0407H
	Y0 ~ Y7	0500H ~ 0507H
DVP-04AD	AD0 ~ AD3	1600H ~ 1603H
DVP02DA	DA0 ~ DA1	1640H ~ 1641H
DVP-08ST	Switch 0 ~ 7	0408H ~ 040FH

Step 3: Physical configuration

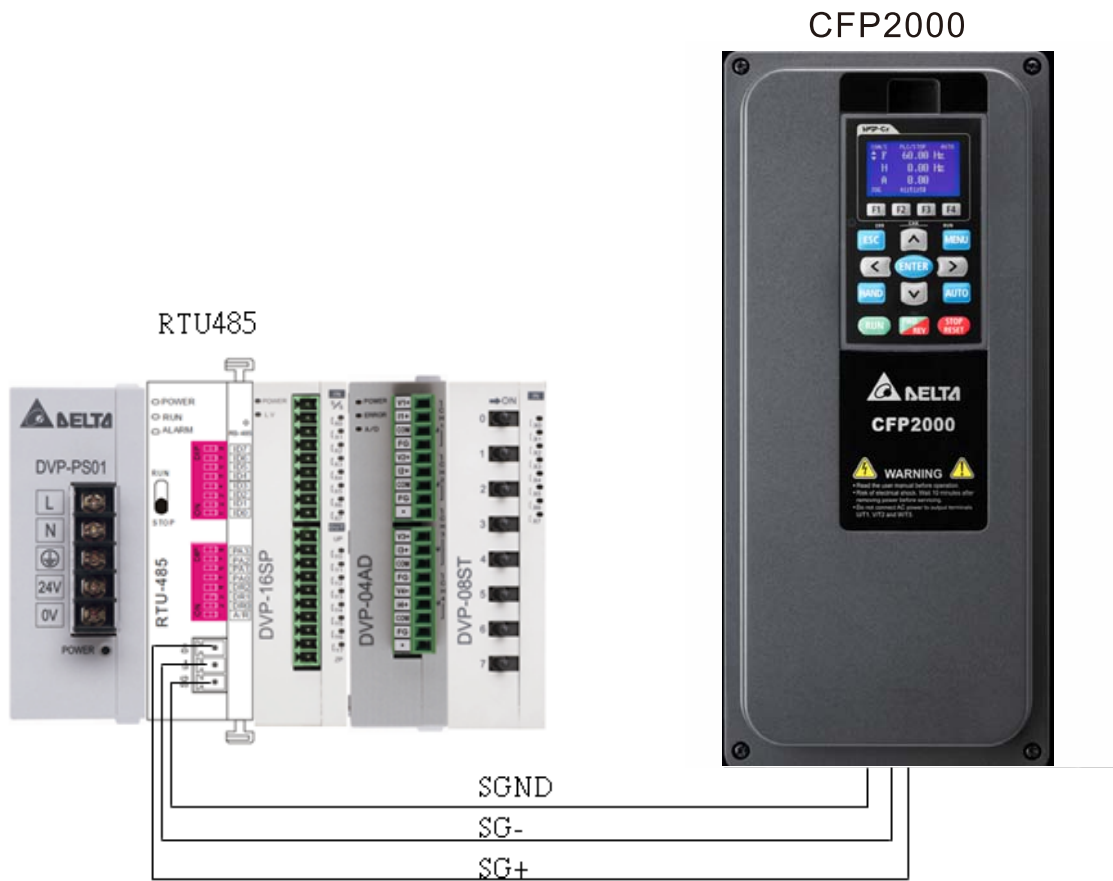

Step 4: Write to PLC program

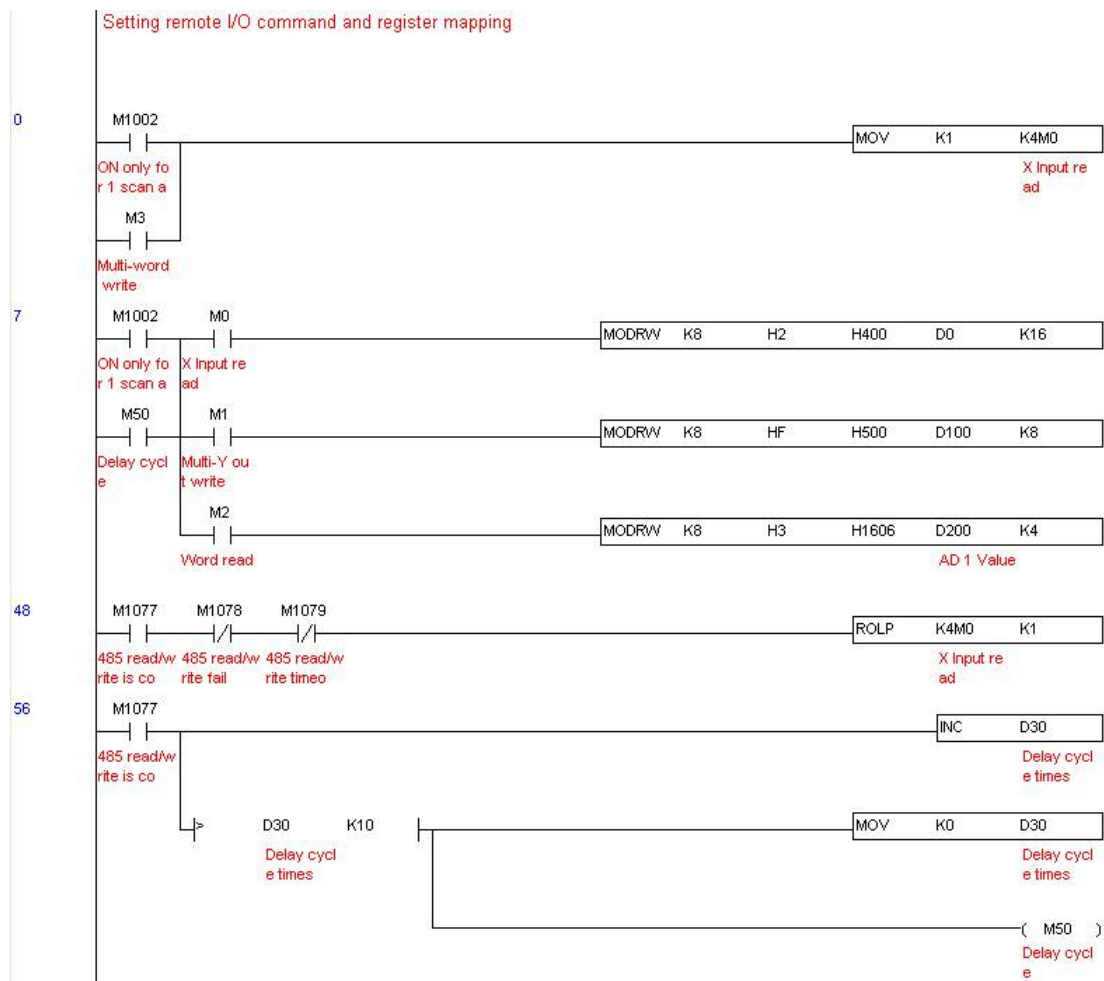

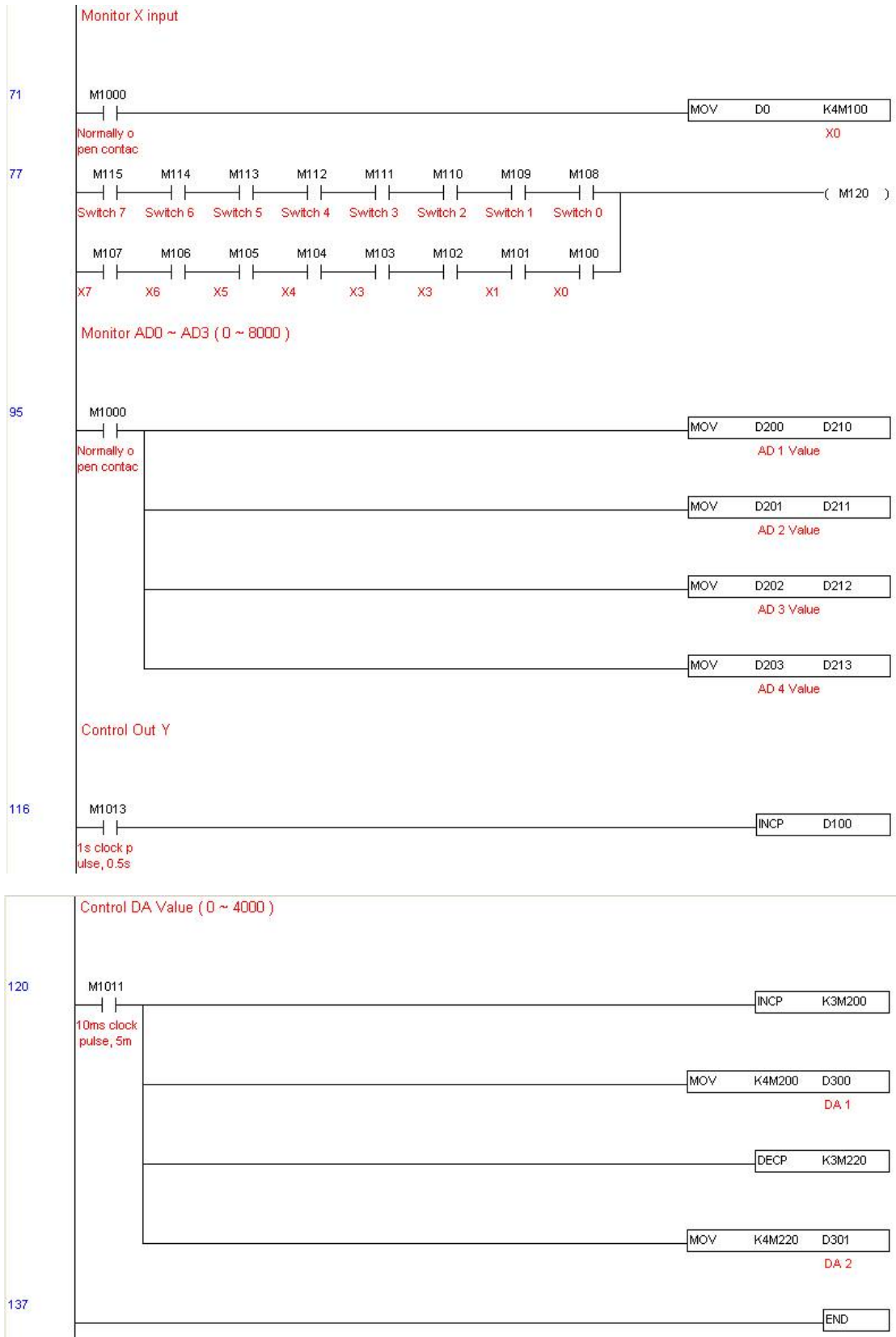

Step 5: Actual testing situation:

I/O testing: When the switch is activated, it can be discovered that the display corresponds to M115 - M108. Furthermore, it can be seen that one output point light is added every 1 sec. (the display uses a binary format)

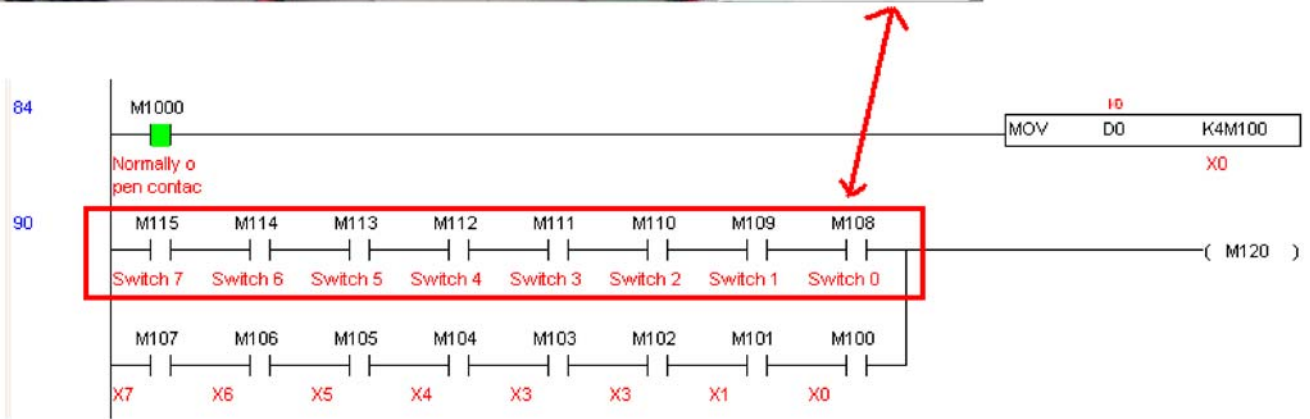
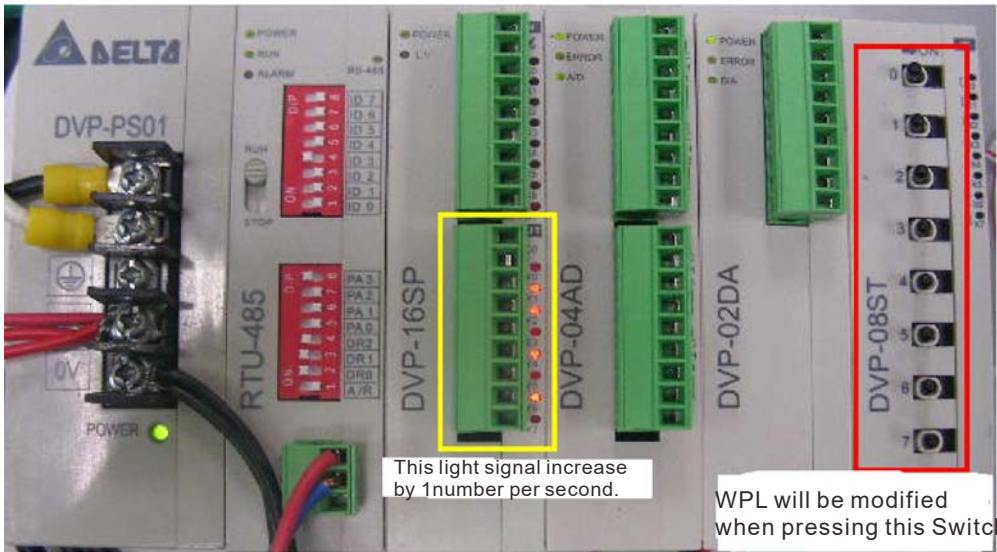

AD DA testing: It can be discovered that D200 and D201 are roughly twice the D300, and continue to increase progressively. For their part, the D202 and D203 are roughly twice the D301, and continue to decrease progressively.

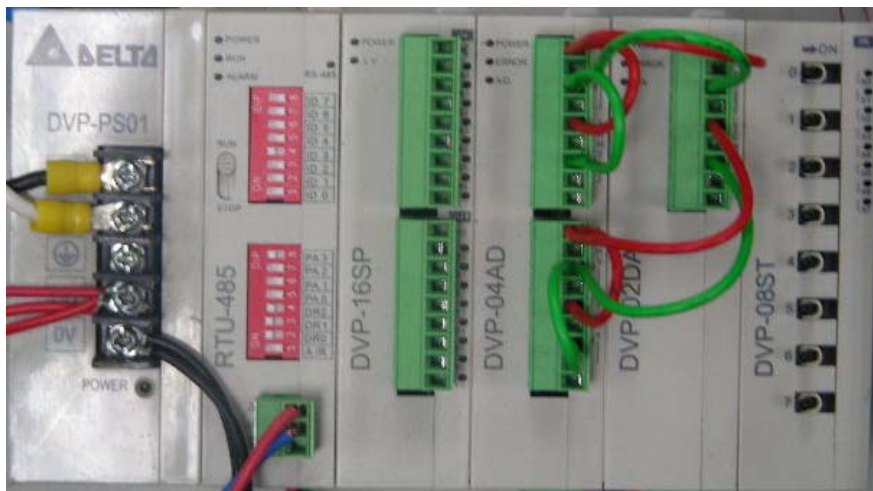

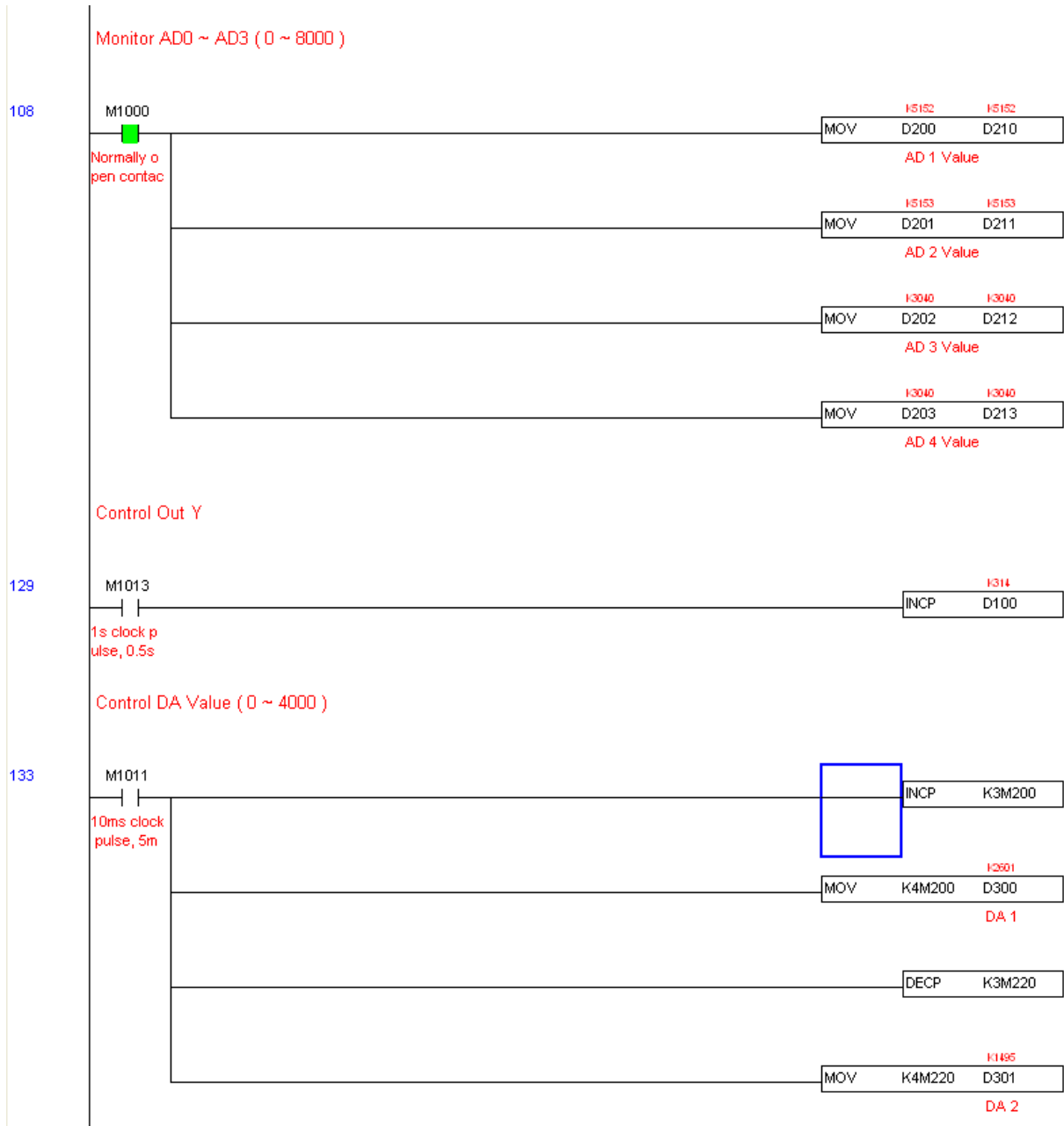

16-12 Calendar functions

Keypad (KPC-CC02) should be connected, or the CFP2000 cannot be used. Currently-support commands include TCMP (comparison of calendar data), TZCP (calendar data range comparison), TADD (calendar data addition), TSub (calendar data subtraction), and TRD (calendar reading). Please refer to the explanation of relevant commands and functions for the usage of these commands.

In real applications, the internal PLC can judge whether calendar function have been activated; if they have been activated, calendar warning codes may be displayed in some situations. The basis for whether a calendar function has been activated is whether the program has written the calendar time (D1063 to D1069) in connection with the foregoing calendar commands or programs.

The calendar's time display is currently assigned to D1063 to D1069, and is defined as follows:

Special D	Item	Content	Attributes
D1063	Year (Western)	20xx (2000~2099)	RO
D1064	Weeks	1~7	RO
D1065	Month	1~12	RO
D1066	Day	1~31	RO
D1067	Hour	0~23	RO
D1068	Minute	0~59	RO
D1069	Second	0~59	RO

Calendar-related special M items are defined as follows:

Special D	Item	Attributes
M1068	Calendar time error	RO
M1076	Calendar time error or refresh time out	RO
M1036	Ignore calendar warning	RW

*When a program writes to the commands TCMP, TZCP, TADD, or TSub, if it is discovered that a value exceeds the reasonable range, M1026 will be 1.

*When the keypad display is PLra (RTC correction warning) or PLrt (RTC time out warning), M1076 will be ON.

*When M1036 is 1, the PLC will ignore the calendar warning.

Calendar trigger warning code is defined as follows:

Warning	Description	Reset approach	Whether it affects PLC operation
PLra	Calendar time correction	Requires power restart	Will not have any effect
PLrt	Calendar time refresh time out	Requires power restart	Will not have any effect

*When the PLC's calendar functions are operating, if the keypad is replaced with another keypad, it will jump to PLra.

*When it is discovered at startup that the keypad has not been powered for more than 7 days, or the time is wrong, PLra will be triggered.

*When it is discovered that the C2000 has no keypad 10 sec. after startup, PLrt will be triggered.

*If the keypad is suddenly pulled out while the calendar is operating normally, and is not reconnected for more than 1 minute, PLrt will be triggered.

Practical applications:

We will perform a demo of simple applications.

We first correct the keypad time. After pressing Menu on the keypad, select the 9th time setting option. After selection, set the current time.

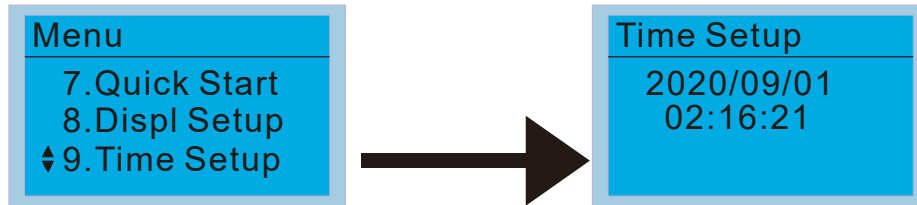

We set converter on during the period of 8:00-17:20, which allows us to write the following example

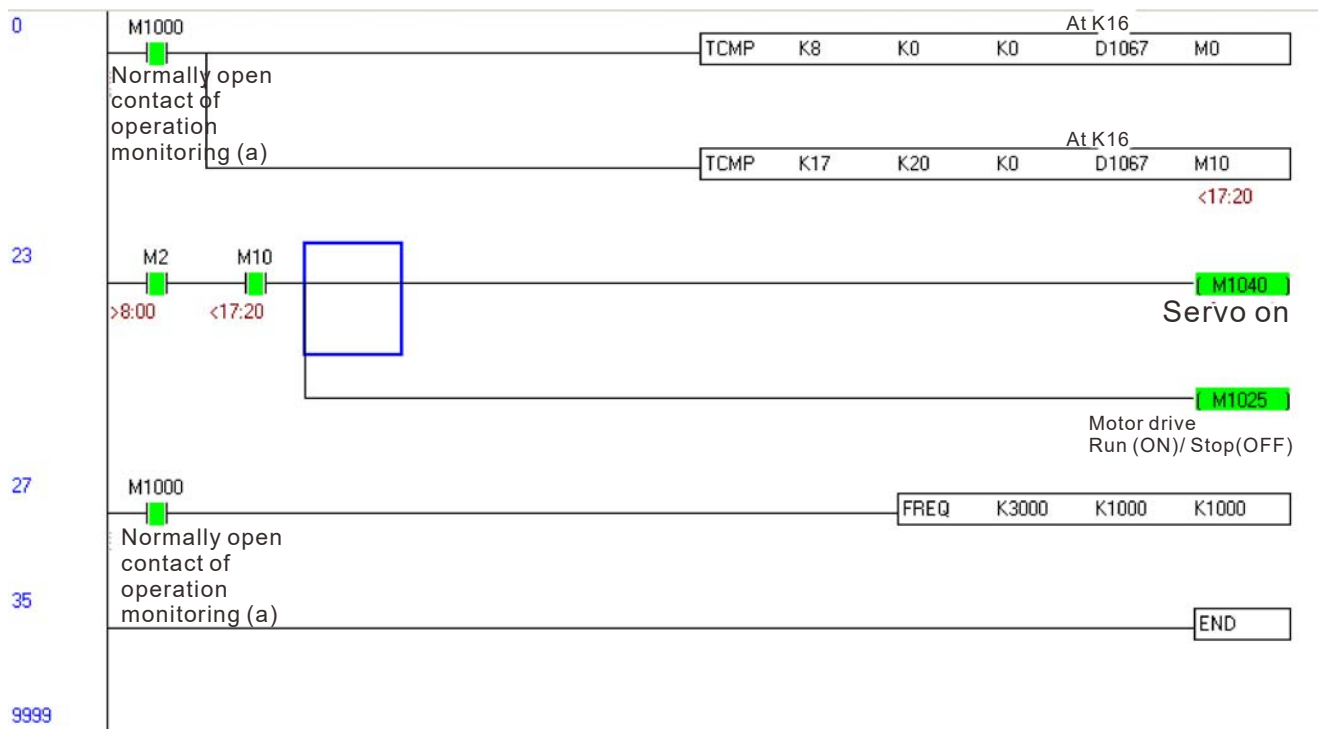

[This page intentionally left blank]

Chapter 17 Introduction to BACnet

1. About BACnet:

BACnet is an ASHRAE communication protocol for **building automation and control networks**. (ASHRAE: **A**merican **S**ociety of **H**eating, **R**efrigerating and **A**ir-**C**onditioning **E**ngineers, Inc.). CFP2000's BACnet is based on version 2004.

BACnet's regulations are related to several kinds of physical layers' interfaces. The physical layer built inside CFP2000 is achieved via MS/TP interface.

The BACnet of CFP2000 supports a device type called B-ASC. B-ASC supports six types of services such as DS-RP-B, DS-RPM-B, DS-WP-B, DM-DDB-B, DM-DOB-B and DM-DCC-B.

2. CFP2000 BACnet-Object and Property:

In CFP2000, BACnet supports 3 object types: Device, AnalogValue (AV) and BinaryValue (BV). In each object type, we have the following table to show the Properties list:

Property ID		Object Type		
		Device	Analog Value	Binary Value
#4	ACTIVE TEXT			V
#11	APDU_TIMEOUT	V		
#12	APPLICATION_SOFTWARE_VERSION	V		
#28	DESCRIPTION	V	V	V
#30	DEVICE ADDRESS BINDING	V	V	
#36	EVENT STATE		V	V
#44	FIRMWARE_REVISION	V		
#46	INACTIVE TEXT			V
#62	MAX_APDU_LENGTH_ACCEPTED	V		
#63	MAX_INFO_FRAMES	V		
#64	MAX_MASTER	V		
#70	MODEL_NAME	V		
#73	NUMBER_OF_APDU_RETRIES	V		
#75	OBJECT_IDENTIFIER	V *1	V	V
#76	OBJECT_LIST	V		
#77	OBJECT_NAME	V *1	V	V
#79	OBJECT_TYPE	V	V	V
#81	OUT OF SERVICE		V	V
#85	PRESENT VALUE		V *2	V *2
#87	PRIORITY ARRAY		V *3	V *3
#96	PROTOCOL_OBJECT_TYPES_SUPPORTED	V		

Property ID		Object Type		
		Device	Analog Value	Binary Value
#97	PROTOCOL_SERVICES_SUPPORTED	V		
#98	PROTOCOL_VERSION	V		
#104	RELINQUISH_DEFAULT		V *3	V *3
#107	SEGMENTATION_SUPPORTED	V		
#111	STATUS_FLAGS		V	V
#112	SYSTEM_STATUS	V		
#117	UNITS		V	
#120	VENDOR_IDENTIFIER	V		
#121	VENDOR_NAME	V		
#139	PROTOCOL_REVISION	V		
#155	DATABASE_REVISION	V		

- *1. The Object_ID and Object_Name Properties of Device are writeable.
- *2. The Present_Value Property of some AV and BV objects is commandable.
- *3. Only Commandable objects support Priority_Array and Relinquish_Default.

The AV objects, we have commandable and readonly cases.

- Commandable case: We can use Write_Service to access the Present_Value property of commandable AV objects. Thus, the commandable AV objects are linking to the Control_Word and Pr_Word in CFP2000.
- Readonly case: We can use Read_Service to access the Present_Value property of readonly AV objects. Thus, these readonly AV objects are linking to the Status_Word in CFP2000.

The BV objects, we also have commandable and readonly cases.

- Commandable case: We can use Write_Service to access the Present_Value property of commendable BV objects. Thus, the commandable BV objects are linking to the Control_Bit in CFP2000.
- Readonly case: We can use Read_Service to access the Present_Value property of readonly BV objects. Thus, these readonly BV objects are linking to the Status_Bit in CFP2000.

2.1 Commandable Analog Value Object

In CFP2000, we have AV_000~AV_026 supporting commandable Present_Value property. For these AV_Objects, we also can use (Multi) Read_Service to access Priority_Array and Relinquish_Default properties.

Object Number	R/W	Object Name	Object Description	Unit
AV 000	RW	Reserved	Reserved	UNITS_NO_UNITS
AV 001	RW	FreqRefValue	Frequency Reference Value	UNITS_HERTZ
AV 002	RW	Reserved	Reserved	UNITS_NO_UNITS
AV 003	RW	Reserved	Reserved	UNITS_NO_UNITS
AV 004	RW	Reserved	Reserved	UNITS_NO_UNITS
AV 005	RW	Reserved	Reserved	UNITS_NO_UNITS
AV 006	RW	Reserved	Reserved	UNITS_NO_UNITS

Object Number	R/W	Object Name	Object Description	Unit
AV 007	RW	Reserved	Reserved	UNITS_NO_UNITS
AV 008	RW	Reserved	Reserved	UNITS_NO_UNITS
AV 009	RW	Reserved	Reserved	UNITS_NO_UNITS
AV 010	RW	Reserved	Reserved	UNITS_NO_UNITS
AV 011	RW	(P9-11 map set)	AV11 will modify data which is P9-11 mapping to	Depends
AV 012	RW	(P9-12 map set)	AV12 will modify data which is P9-12 mapping to	Depends
AV 013	RW	(P9-13 map set)	AV13 will modify data which is P9-13 mapping to	Depends
AV 014	RW	(P9-14 map set)	AV14 will modify data which is P9-14 mapping to	Depends
AV 015	RW	(P9-15 map set)	AV15 will modify data which is P9-15 mapping to	Depends
AV 016	RW	(P9-16 map set)	AV16 will modify data which is P9-16 mapping to	Depends
AV 017	RW	(P9-17 map set)	AV17 will modify data which is P9-17 mapping to	Depends
AV 018	RW	(P9-18 map set)	AV18 will modify data which is P9-18 mapping to	Depends
AV 019	RW	(P9-19 map set)	AV19 will modify data which is P9-19 mapping to	Depends
AV 020	RW	(P9-20 map set)	AV20 will modify data which is P9-20 mapping to	Depends
AV 021	RW	(P9-21 map set)	AV21 will modify data which is P9-21 mapping to	Depends
AV 022	RW	(P9-22 map set)	AV22 will modify data which is P9-22 mapping to	Depends
AV 023	RW	(P9-23 map set)	AV23 will modify data which is P9-23 mapping to	Depends
AV 024	RW	(P9-24 map set)	AV24 will modify data which is P9-24 mapping to	Depends
AV 025	RW	(P9-25 map set)	AV25 will modify data which is P9-25 mapping to	Depends
AV 026	RW	(P9-26 map set)	AV26 will modify data which is P9-26 mapping to	Depends

2.2 Status (Readonly) Analog Value Object

In CFP2000, we have AV_027~AV_068 with readonly Present_Value property. For these AV_Objects, we do NOT have Priority_Array and Relinquish_Default properties.

Object Number	R/W	Object Name	Object Description	Unit
AV 027	R	Reserved	Reserved	UNITS_NO_UNITS
AV 028	R	Reserved	Reserved	UNITS_NO_UNITS
AV 029	R	Reserved	Reserved	UNITS_NO_UNITS
AV 030	R	Reserved	Reserved	UNITS_NO_UNITS
AV 031	R	Output frequency	Display output frequency(Hz)	UNITS_HERTZ
AV 032	R	Reserved	Reserved	UNITS_NO_UNITS
AV 033	R	Reserved	Reserved	UNITS_NO_UNITS
AV 034	R	Reserved	Reserved	UNITS_NO_UNITS
AV 035	R	Output torque (%)	Display output torque (%)	UNITS_PERCENT
AV 036	R	Reserved	Reserved	UNITS_NO_UNITS
AV 037	R	Reserved	Reserved	UNITS_NO_UNITS
AV 038	R	Reserved	Reserved	UNITS_NO_UNITS
AV 039	R	Status word	Display status word,made from BV16~BV31	UNITS_NO_UNITS

Object Number	R/W	Object Name	Object Description	Unit
AV 040	R	Reserved	Reserved	UNITS_NO_UNITS
AV 041	R	Driver type code	Driver type code	UNITS_NO_UNITS
AV 042	R	Warn code	Warn code	UNITS_NO_UNITS
AV 043	R	Error code	Error code	UNITS_NO_UNITS
AV 044	R	Output current	Display output current(Amp)	UNITS_AMPERES
AV 045	R	DC-bus voltage	Display DC-BUS voltage(Volt)	UNITS_VOLTS
AV 046	R	Output Voltage	Display output voltage of U, V, W(Volt)	UNITS_VOLTS
AV 047	R	Count Value	Display counter value of TRG terminal	UNITS_NO_UNITS
AV 048	R	Power Angle	Display output power angle of U, V, W	UNITS_POWER_FACTOR
AV 049	R	Output Power	Display actual output power of U, V, W(kw)	UNITS_KILOWATTS
AV 050	R	IGBT temperature	Display the IGBT temperature	UNITS_DEGREES_CELSIUS
AV 051	R	Temperature of driver	Display the temperature of capacitance	UNITS_DEGREES_CELSIUS
AV 052	R	Real carry frequency	Display real carrier frequency of the drive(KHz)	UNITS_KILOHERTZ
AV 053	R	PID feedback value	Display PID feedback value (%)	UNITS_PERCENT
AV 054	R	Overload rate	Display overload condition (%)	UNITS_PERCENT
AV 055	R	Ground fail detect level	Display GND fail detect level (%)	UNITS_PERCENT
AV 056	R	DC bus ripple	Display DCbus voltage ripples(Volt)	UNITS_VOLTS
AV 057	R	Fan Speed	Fan speed of the drive (%)	UNITS_PERCENT
AV 058	R	Output speed(rpm)	Output speed(rpm)	UNITS_REVOLUTIONS_PER_MINUTE
AV 059	R	KW per Hour	KW per Hour	UNITS_KILOWATTS
AV 060	R	Multi-speed switch	Real multi-speed switch	UNITS_NO_UNITS
AV 061	R	AVI1 input value	0~10V corresponds to 0~100%	UNITS_PERCENT
AV 062	R	ACI input value	4~20mA/0~10V corresponds to 0~100%	UNITS_PERCENT
AV 063	R	AVI2 input value	0V~10V corresponds to 0~100%	UNITS_PERCENT
AV 064	R	Digital input status	Refer to P2-12	UNITS_NO_UNITS
AV 065	R	Digital output status	Refer to P2-18	UNITS_NO_UNITS
AV 066	R	CPU pin status of DI	Corresponding CPU pin status of digital input	UNITS_NO_UNITS
AV 067	R	CPU pin status of DO	Corresponding CPU pin status of digital output	UNITS_NO_UNITS
AV 068	R	PLC D1043 value	PLC D1043 value	UNITS_NO_UNITS

2.3 Commandable Binary Value Object

In CFP2000, we have BV_000~BV_015 supporting commandable Present_Value property. For these BV_Objects, we also can use (Multi) Read_Service to access Priority_Array and Relinquish_Default properties.

Object Number	R/W	Object Name	Object Description
BV 000	RW	ACTIVE CMD	(0)FreqCmd=0;(1)FreqCmd=FreqRefValue
BV 001	RW	FWD/REV CMD	(0)Forward; (1)Reverse
BV 002	RW	Reserved	Reserved
BV 003	RW	HALT CMD	(0)None;(1)RampDown to 0Hz.
BV 004	RW	LOCK CMD	(0)None;(1)OutputFreq stays at current frequency
BV 005	RW	Reserved	Reserved
BV 006	RW	QSTOP CMD	(0)None;(1)Force driver quick stop
BV 007	RW	ServoPower CMD	(0)PowerOff(free run to stop);(1)PowerOn
BV 008	RW	Reserved	Reserved
BV 009	RW	Reserved	Reserved
BV 010	RW	Reserved	Reserved
BV 011	RW	Reserved	Reserved
BV 012	RW	Reserved	Reserved
BV 013	RW	Reserved	Reserved
BV 014	RW	Reserved	Reserved
BV 015	RW	RESET	RESET:(0)Do nothing;(1)Reset fault

2.4 Status (Readonly) Binary Value Object

In CFP2000, we have BV_016~BV_031 with readonly Present_Value property. For these BV_Objects, we do NOT have Priority_Array and Relinquish_Default properties.

Object Number	R/W	Object Name	Object Description
BV 016	R	ARRIVE STATE	(0)Not yet;(1)Arrive (OutputFreq=FreqCmd)
BV 017	R	FWD/REV STATE	(0)Forward;(1)Reverse
BV 018	R	WARN STATE	(0)No Warn;(1)Occur Warn
BV 019	R	ERROR STATE	(0)No Error;(1)Occur Error
BV 020	R	Reserved	Reserved
BV 021	R	Reserved	Reserved
BV 022	R	QSTOP STATE	(0)No QSTOP;(1)Occur QSTOP
BV 023	R	ServoPower STATE	(0)PowerOff(free run to stop);(1)PowerOn
BV 024	R	Reserved	Reserved
BV 025	R	Reserved	Reserved
BV 026	R	Reserved	Reserved
BV 027	R	Reserved	Reserved

Object Number	R/W	Object Name	Object Description
BV 028	R	Reserved	Reserved
BV 029	R	Reserved	Reserved
BV 030	R	Reserved	Reserved
BV 031	R	Reserved	Reserved

3. Steps to setup the Pr about BACnet in CFP2000

Related to BACnet function in CFP2000, We have to configure 2 parts of Pr.

Part1. Setup parameters related to Communication at Pr_Group9.

Part2. Setup parameters related to System_Parameter at Pr_Group0.

Part1. Pr_Group9, Communication.

1-1. Set Pr09-31 =1, BACnet is enabled, then the COM1_Port will be accessed by BACnet. When this is set, the COM1_Port communication format will be changed to RTU 8, N, 1.

(Note: The HW Pins of COM1_Port are shared by RJ45 and RS485. When BACnet is enabled, BACnet will access the COM1_Port, that also means we can **NOT** have Modbus, PLC connections, VFDSOft and VFD Explorer by COM1_Port).

1-2. Set Pr09-50, Default = 10, BACnet's MS/TP station number 0~127

1-3. Set Pr09-51, Default = 38400, BACnet communication baud rate, 9600, 19200, 38400 or 76800bps.

1-4. Set Pr09-52 and Pr09-53, the default setting of Device Object_Identifier is 0x000A (Pr09-52=10, Pr09-53=00). Device Object_Identifier is the combination of Pr09-52 and Pr09-53, thus the setting range can be 0~4194303.

For example, Pr09-53=12(0x0C) and Pr09-52 =3456(0x0D80), then the device Identifier's value =12*65536+3456 =789888(0x0C0D80).

1-5. Set Pr09-55, Default =127, the highest allowable address for master nodes on the same MS/TP network. CFP2000 base on this setting to know the Max search range.

1-6. Set Pr09-56, setup the BACnet password. If setup is successful, the keypad will display 8888.

Part2. Pr_Group0, System Parameter.

2-1. Set Pr00-20 =1, that means the source of the Frequency command is from RS485 Interface (accessed by BACnet).

2-2. Set Pr00-21 =2, that means the source of the Operation command is from RS485 Interface (accessed by BACnet).

Here is a simple example:

After setting up the 2 parts of Pr, we can enable the BACnet function in CFP2000. Thus, we can access some BACnet objects to make the CFP2000 driving motor Run or Stop.

Step1. Write_Service on AV_001, Present_Value =60.0 → Setup Frequency Reference Value.

Step2. Write_Service on BV_007, Present_Value =Active. → Setup Servo Power CMD.

Step3. Write_Service on BV_000, Present_Value =Active. → Setup Active CMD.

Step4. Read_Service on AV_031, Present_Value → User can know the Output frequency.

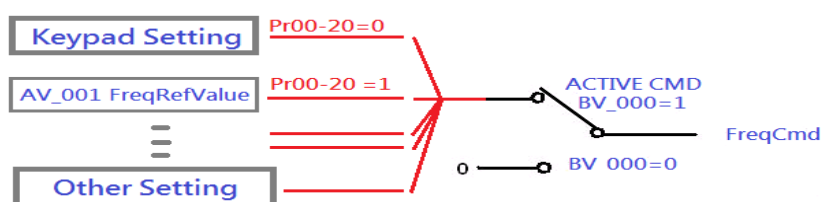

PS. In CFP2000, based on different Pr setting or IO setting, we can make FreqCmd with different source of Reference Value.

Please check the usage of Keypad, Pr and IO setting for more detail information.

- Connection of the communication cable as shown in the below diagram.
Please note that HW Pins of COM1_Port are shared by RJ45 and RS485. That means user can use RJ45_cable or RS485_lines to access the COM1_Port.
When BACnet is enabled, COM1_Port will be dominated by BACnet function. Under this condition, user will not be able to have MODBUS VFD Soft, VFD Explorer or PLC function on COM1_Port.

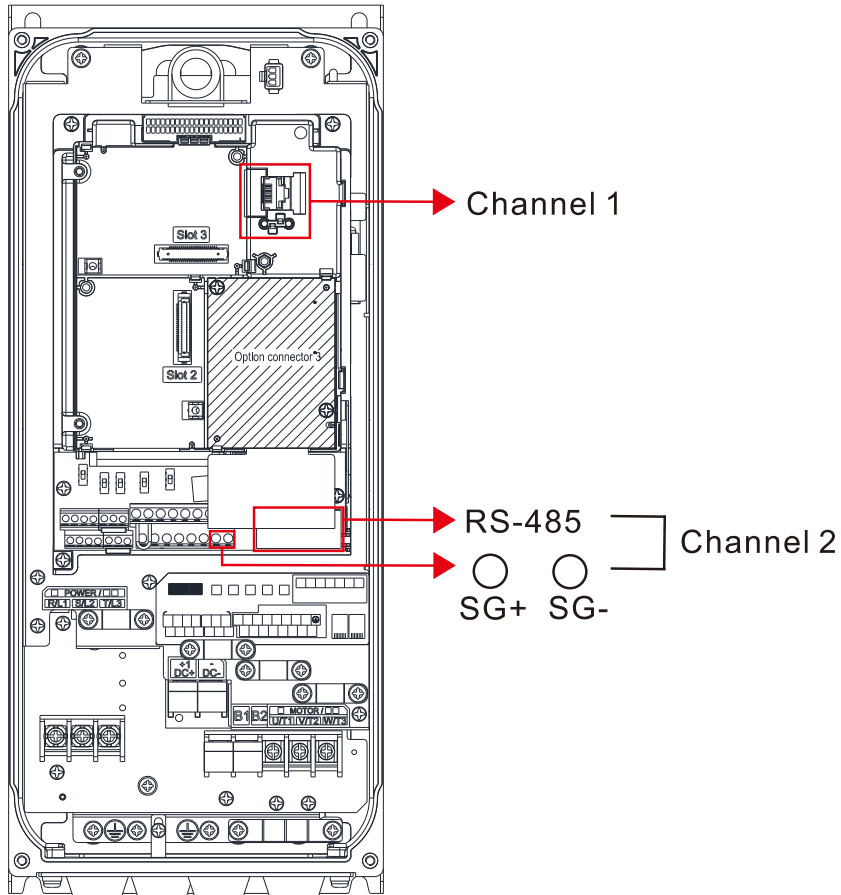

BACnet Protocol Implementation Conformance Statement**Date :** July 24, 2014**Vendor Name:** Delta Electronics, Inc.**Product Name:** CFP2000**Product Model Number:** VFD-CFP2000**Applications Software Version:** Ver 01.04- yyyymm **Firmware Revision:** Ver 01.04 **BACnet Protocol Revision:** 7**Product Description:**

Delta VFD-CFP2000 is a Variable Frequency AC motor Drive with BACnet embedded.

In VFD-CFP2000, the BACnet connection is by MS/TP, RS485-based. VFD-CFP2000 provides a BACnet communication function that permits it as a server and supports BIBBs defined by the BACnet B-ASC.

VFD-CFP2000 BACnet provides the capability to control and monitor the VFD-CFP2000 machine.

BACnet Standardized Device Profile (Annex L):

- BACnet Operator Workstation (B-OWS)_
- BACnet Building Controller (B-BC)
- BACnet Advanced Application Controller (B-AAC)_
- BACnet Application Specific Controller (B-ASC)
- BACnet Smart Sensor (B-SS)
- BACnet Smart Actuator (B-SA)

List all BACnet Interoperability Building Blocks Supported (Annex K):**Data Sharing BIBBs**

Data Sharing-ReadProperty-B (DS-RP-B)

Data Sharing-WriteProperty-B (DS-WP-B)

Data Sharing-ReadPropertyMultiple-B (DS-RPM-B)

Device and Network Management BIBBs

Device Management-Dynamic Device Binding-B (DM-DDB-B)

Device Management-Dynamic Object Binding-B (DM-DOB-B)

Device Management-DeviceCommunicationControl-B (DM-DCC-B)

Segmentation Capability:

- Segmented requests supported Window Size _____
- Segmented responses supported Window Size _____

Standard Object Types Supported:

Analog Value
Binary Value
Device

Object instantiation is static. Refer to table at end of this document for object details.

Data Link Layer Options:

- BACnet IP, (Annex J)
- BACnet IP, (Annex J), Foreign Device
- ISO 8802-3, Ethernet (Clause 7)
- ANSI/ATA 878.1, 2.5 Mb. ARCNET (Clause 8)
- ANSI/ATA 878.1, RS-485 ARCNET (Clause 8), baud rate(s) _____
- MS/TP master (Clause 9), baud rate(s): 9600, 19200, 38400, 76800
- MS/TP slave (Clause 9), baud rate(s): _____
- Point-To-Point, EIA 232 (Clause 10), baud rate(s): _____
- Point-To-Point, modem, (Clause 10), baud rate(s): _____
- LonTalk, (Clause 11), medium: _____
- Other: _____

Device Address Binding:

Is static device binding supported? (This is currently necessary for two-way communication with MS/TP slaves and certain other devices.) Yes No

Networking Options:

- Router, Clause 6 - List all routing configurations, e.g., ARCNET-Ethernet, Ethernet-MS/TP, etc.
 - Annex H, BACnet Tunneling Router over IP
 - BACnet/IP Broadcast Management Device (BBMD)
- Does the BBMD support registrations by Foreign Devices? Yes No

Character Sets Supported:

Indicating support for multiple character sets does not imply that they can all be supported simultaneously.

- ANSI X3.4
- IBM™/Microsoft™ DBCS
- ISO 8859-1
- ISO 10646 (UCS-2)
- ISO 10646 (UCS-4)
- JIS C 6226

If this product is a communication gateway, describe the types of non-BACnet equipment/networks(s) that the gateway supports:

The Properties of Objects

Property ID		Object Type		
		Device	Analog Value	Binary Value
#4	ACTIVE TEXT			V
#11	APDU_TIMEOUT	V		
#12	APPLICATION_SOFTWARE_VERSION	V		
#28	DESCRIPTION	V	V	V
#30	DEVICE ADDRESS BINDING	V	V	
#36	EVENT STATE		V	V
#44	FIRMWARE_REVISION	V		
#46	INACTIVE TEXT			V
#62	MAX_APDU_LENGTH_ACCEPTED	V		
#63	MAX_INFO_FRAMES	V		
#64	MAX_MASTER	V		
#70	MODEL_NAME	V		
#73	NUMBER_OF_APDU_RETRIES	V		
#75	OBJECT_IDENTIFIER	V *1	V	V
#76	OBJECT_LIST	V		
#77	OBJECT_NAME	V *1	V	V
#79	OBJECT_TYPE	V	V	V
#81	OUT OF SERVICE		V	V
#85	PRESENT VALUE		V *2	V *2
#87	PRIORITY ARRAY		V *3	V *3
#96	PROTOCOL_OBJECT_TYPES_SUPPORTED	V		
#97	PROTOCOL_SERVICES_SUPPORTED	V		
#98	PROTOCOL_VERSION	V		
#104	RELINQUISH DEFAULT		V *3	V *3
#107	SEGMENTATION_SUPPORTED	V		
#111	STATUS FLAGS		V	V
#112	SYSTEM_STATUS	V		
#117	UNITS		V	
#120	VENDOR_IDENTIFIER	V		
#121	VENDOR_NAME	V		
#139	PROTOCOL_REVISION	V		
#155	DATABASE_REVISION	V		

*1. The Object_ID and Object_Name Properties of Device are writeable.

*2. The Present_Value Property of some AV and BV objects are commandable.

*3. Only Commandable objects support Priority_Array and Relinquish_Default.

● Commandable Analog Value Object

In VFD-CFP2000, we have AV_000~AV_026 supporting commandable Present_Value property. In these AV_Objects, we also can use (Multi) Read_Service to access Priority_Array and Relinquish_Default properties.

Object Number	R/W	Object Name	Object Description	Unit
AV 000	RW	AV_000_Reserved	Reserved	UNITS_NO_UNITS
AV 001	RW	AV_001_FreqRefValue	Frequency Reference Value	UNITS_HERTZ
AV 002	RW	AV_002_Reserved	Reserved	UNITS_NO_UNITS
AV 003	RW	AV_003_Reserved	Reserved	UNITS_NO_UNITS
AV 004	RW	AV_004_Reserved	Reserved	UNITS_NO_UNITS
AV 005	RW	AV_005_Reserved	Reserved	UNITS_NO_UNITS
AV 006	RW	AV_006_Reserved	Reserved	UNITS_NO_UNITS
AV 007	RW	AV_007_Reserved	Reserved	UNITS_NO_UNITS
AV 008	RW	AV_008_Reserved	Reserved	UNITS_NO_UNITS
AV 009	RW	AV_009_Reserved	Reserved	UNITS_NO_UNITS
AV 010	RW	AV_010_Reserved	Reserved	UNITS_NO_UNITS
AV 011	RW	AV_011_P9-11 map set= -----	AV11 will modify data which is P9-11 mapping to	Depends
AV 012	RW	AV_012_P9-12 map set= -----	AV12 will modify data which is P9-12 mapping to	Depends
AV 013	RW	AV_013_P9-13 map set= -----	AV13 will modify data which is P9-13 mapping to	Depends
AV 014	RW	AV_014_P9-14 map set= -----	AV14 will modify data which is P9-14 mapping to	Depends
AV 015	RW	AV_015_P9-15 map set= -----	AV15 will modify data which is P9-15 mapping to	Depends
AV 016	RW	AV_016_P9-16 map set= -----	AV16 will modify data which is P9-16 mapping to	Depends
AV 017	RW	AV_017_P9-17 map set= -----	AV17 will modify data which is P9-17 mapping to	Depends
AV 018	RW	AV_018_P9-18 map set= -----	AV18 will modify data which is P9-18 mapping to	Depends
AV 019	RW	AV_019_P9-19 map set= -----	AV19 will modify data which is P9-19 mapping to	Depends
AV 020	RW	AV_020_P9-20 map set= -----	AV20 will modify data which is P9-20 mapping to	Depends
AV 021	RW	AV_021_P9-21 map set= -----	AV21 will modify data which is P9-21 mapping to	Depends
AV 022	RW	AV_022_P9-22 map set= -----	AV22 will modify data which is P9-22 mapping to	Depends
AV 023	RW	AV_023_P9-23 map set= -----	AV23 will modify data which is P9-23 mapping to	Depends
AV 024	RW	AV_024_P9-24 map set= -----	AV24 will modify data which is P9-24 mapping to	Depends
AV 025	RW	AV_025_P9-25 map set= -----	AV25 will modify data which is P9-25 mapping to	Depends
AV 026	RW	AV_026_P9-26 map set= -----	AV26 will modify data which is P9-26 mapping to	Depends

- **Status (Readonly) Analog Value Object**

In VFD-CFP2000, we have AV_027~AV_068 with readonly Present_Value property. In these AV_Objects, we do NOT have Priority_Array and Relinquish_Default properties.

Object Number	R/W	Object Name	Object Description	Unit
AV 027	R	AV_027_Reserved	Reserved	UNITS_NO_UNITS
AV 028	R	AV_028_Reserved	Reserved	UNITS_NO_UNITS
AV 029	R	AV_029_Reserved	Reserved	UNITS_NO_UNITS
AV 030	R	AV_030_Reserved	Reserved	UNITS_NO_UNITS
AV 031	R	AV_031_Output frequency	Display output frequency(Hz)	UNITS_HERTZ
AV 032	R	AV_032_Reserved	Reserved	UNITS_NO_UNITS
AV 033	R	AV_033_Reserved	Reserved	UNITS_NO_UNITS
AV 034	R	AV_034_Reserved	Reserved	UNITS_NO_UNITS
AV 035	R	AV_035_Output torque (%)	Display output torque (%)	UNITS_PERCENT
AV 036	R	AV_036_Reserved	Reserved	UNITS_NO_UNITS
AV 037	R	AV_037_Reserved	Reserved	UNITS_NO_UNITS
AV 038	R	AV_038_Reserved	Reserved	UNITS_NO_UNITS
AV 039	R	AV_039_Status word	Display status word,made from BV16~BV31	UNITS_NO_UNITS
AV 040	R	AV_040_Reserved	Reserved	UNITS_NO_UNITS
AV 041	R	AV_041_Driver type code	Driver type code	UNITS_NO_UNITS
AV 042	R	AV_042_Warn code	Warn code	UNITS_NO_UNITS
AV 043	R	AV_043_Error code	Error code	UNITS_NO_UNITS
AV 044	R	AV_044_Output current	Display output current(Amp)	UNITS_AMPERES
AV 045	R	AV_045_DC-bus voltage	Display DC-BUS voltage(Volt)	UNITS_VOLTS
AV 046	R	AV_046_Output Voltage	Display output voltage of U, V, W(Volt)	UNITS_VOLTS
AV 047	R	AV_047_Count Value	Display counter value of TRG terminal	UNITS_NO_UNITS
AV 048	R	AV_048_Power Angle	Display output power angle of U, V, W	UNITS_POWER_FACTOR
AV 049	R	AV_049_Output Power	Display actual output power of U, V, W(kw)	UNITS_KILOWATTS
AV 050	R	AV_050_IGBT temperature	Display the IGBT temperature	UNITS_DEGREES_CELSIUS
AV 051	R	AV_051_Temperature of driver	Display the temperature of capacitance	UNITS_DEGREES_CELSIUS
AV 052	R	AV_052_Real carry frequency	Display real carrier frequency of the drive(KHz)	UNITS_KILOHERTZ
AV 053	R	AV_053_PID feedback value	Display PID feedback value (%)	UNITS_PERCENT
AV 054	R	AV_054_Overload rate	Display overload condition (%)	UNITS_PERCENT
AV 055	R	AV_055_Ground fail detect level	Display GND fail detect level (%)	UNITS_PERCENT
AV 056	R	AV_056_DC bus ripple	Display DCbus voltage ripples(Volt)	UNITS_VOLTS
AV 057	R	AV_057_Fan Speed	Fan speed of the drive (%)	UNITS_PERCENT
AV 058	R	AV_058_Output speed(rpm)	Output speed(rpm)	UNITS_REVOLUTION

Object Number	R/W	Object Name	Object Description	Unit
				S_PER_MINUTE
AV 059	R	AV_059_KW per Hour	KW per Hour	UNITS_KILOWATTS
AV 060	R	AV_060_Multi-speed switch	Real multi-speed switch	UNITS_NO_UNITS
AV 061	R	AV_061_AVI1 input value	0~10V corresponds to 0~100%	UNITS_PERCENT
AV 062	R	AV_062_ACI input value	4~20mA/0~10V corresponds to 0~100%	UNITS_PERCENT
AV 063	R	AV_063_AVI2 input value	0V~10V corresponds to 0~100%	UNITS_PERCENT
AV 064	R	AV_064_Digital input status	Refer to P2-12	UNITS_NO_UNITS
AV 065	R	AV_065_Digital output status	Refer to P2-18	UNITS_NO_UNITS
AV 066	R	AV_066_CPU pin status of DI	Corresponding CPU pin status of digital input	UNITS_NO_UNITS
AV 067	R	AV_067_CPU pin status of DO	Corresponding CPU pin status of digital output	UNITS_NO_UNITS
AV 068	R	AV_068_PLC D1043 value	PLC D1043 value	UNITS_NO_UNITS

● **Commandable Binary Value Object**

In VFD-CFP2000, we have BV_000~BV_015 supporting commandable Present_Value property. In these BV_Objects, we also can use (Multi) Read_Service to access Priority_Array and Relinquish_Default properties.

Object Number	R/W	Object Name	Object Description
BV 000	RW	BV_000_ACTIVE CMD	(0)FreqCmd=0;(1)FreqCmd=FreqRefValue
BV 001	RW	BV_001_FWD/REV CMD	(0)Forward; (1)Reverse
BV 002	RW	BV_002_Reserved	Reserved
BV 003	RW	BV_003_HALT CMD	(0)None;(1)RampDown to 0Hz.
BV 004	RW	BV_004_LOCK CMD	(0)None;(1)OutputFreq stays at current frequency
BV 005	RW	BV_005_Reserved	Reserved
BV 006	RW	BV_006_QSTOP CMD	(0)None;(1)Force driver quick stop
BV 007	RW	BV_007_ServoPower CMD	(0)PowerOff(free run to stop);(1)PowerOn
BV 008	RW	BV_008_Reserved	Reserved
BV 009	RW	BV_009_Reserved	Reserved
BV 010	RW	BV_010_Reserved	Reserved
BV 011	RW	BV_011_Reserved	Reserved
BV 012	RW	BV_012_Reserved	Reserved
BV 013	RW	BV_013_Reserved	Reserved
BV 014	RW	BV_014_Reserved	Reserved
BV 015	RW	BV_015_RESET	RESET:(0)Do nothing;(1)Reset fault

- **Status (Readonly) Binary Value Object**

In VFD-CFP2000, we have BV_016~BV_031 with readonly Present_Value property. In these BV_Objects, we do NOT have Priority_Array and Relinquish_Default properties.

Object Number	R/W	Object Name	Object Description
BV 016	R	BV_016_ARRIVE STATE	(0)Not yet;(1)Arrive (OutputFreq=FreqCmd)
BV 017	R	BV_017_FWD/REV STATE	(0)Forward;(1)Reverse
BV 018	R	BV_018_WARN STATE	(0)No Warn;(1)Occur Warn
BV 019	R	BV_019_ERROR STATE	(0)No Error;(1)Occur Error
BV 020	R	BV_020_Reserved	Reserved
BV 021	R	BV_021_Reserved	Reserved
BV 022	R	BV_022_QSTOP STATE	(0)No QSTOP;(1)Occur QSTOP
BV 023	R	BV_023_ServoPower STATE	(0)PowerOff(free run to stop);(1)PowerOn
BV 024	R	BV_024_Reserved	Reserved
BV 025	R	BV_025_Reserved	Reserved
BV 026	R	BV_026_Reserved	Reserved
BV 027	R	BV_027_Reserved	Reserved
BV 028	R	BV_028_Reserved	Reserved
BV 029	R	BV_029_Reserved	Reserved
BV 030	R	BV_030_Reserved	Reserved
BV 031	R	BV_031_Reserved	Reserved

[This page intentionally left blank]

Chapter 18 Safe Torque Off Function

18-1 The drive safety function failure rate

18-2 Safe Torque Off terminal function description

18-3 Wiring diagram

18-4 Parameter

18-5 Operating sequence description

18-6 New error code for STO function

18-1 The drive safety function failure rate

Item	Definition	Standard	Performance
STO	Safe Torque Off	IEC61508	Channel 1: 80.08% Channel 2: 68.91%
HFT (Type A subsystem)	Hardware Fault Tolerance	IEC61508	1
SIL	Safety Integrity Level	IEC61508	SIL 2
		IEC62061	SILCL 2
PFH	Average frequency of dangerous failure [h ⁻¹]	IEC61508	9.56×10 ⁻¹⁰
PFD _{av}	Probability of Dangerous Failure on Demand	IEC61508	4.18×10 ⁻⁶
Category	Category	ISO13849-1	Category 3
PL	Performance level	ISO13849-1	d
MTTF _d	Mean time to dangerous failure	ISO13849-1	High
DC	Diagnostic coverage	ISO13849-1	Low

18-2 Safe Torque Off terminal function description







The Safe Torque Off function is to cut off the power supply to motor through the hardware, thereby the motor couldn't produce torque.

The Safe Torque Off function controls the motor current drive signal respectively by two independent hardware, and thus cut off the inverter power module output in order to achieve the status of safety stop.

Operation principle Description as below table 1:

Table 1: Terminal operation description

Signal	Channel	Photo-coupler status			
STO signal	STO1~SCM1	ON(High)	ON(High)	OFF(Low)	OFF(Low)
	STO2~SCM2	ON(High)	OFF(Low)	ON(Low)	OFF(Low)
Driver Output status		Ready	STL2 mode (Torque output off)	STL1 mode (torque output off)	STO mode (Torque output off)

-  STO means Safe Torque Off
-  STL1~STL3 means Safety Torque Off hardware abnormal.
-  STL3 means STO1~SCM1 and STO2~SCM2 internal circuit detected abnormal.
-  STO1~SCM1 ON(High): means STO1~SCM1 has connect to a +24VDC power supply.
-  STO2~SCM2 ON(High): means STO2~SCM2 has connect to a +24V power supply.
-  STO1~SCM1 OFF(Low): means STO1~SCM1 hasn't connect to a +24VDC power supply.
-  STO2~SCM2 OFF(Low): means STO2~SCM2 hasn't connect to a +24VDC power supply.

18-3 Wiring diagram

18-3-1 Internal STO circuit as below:

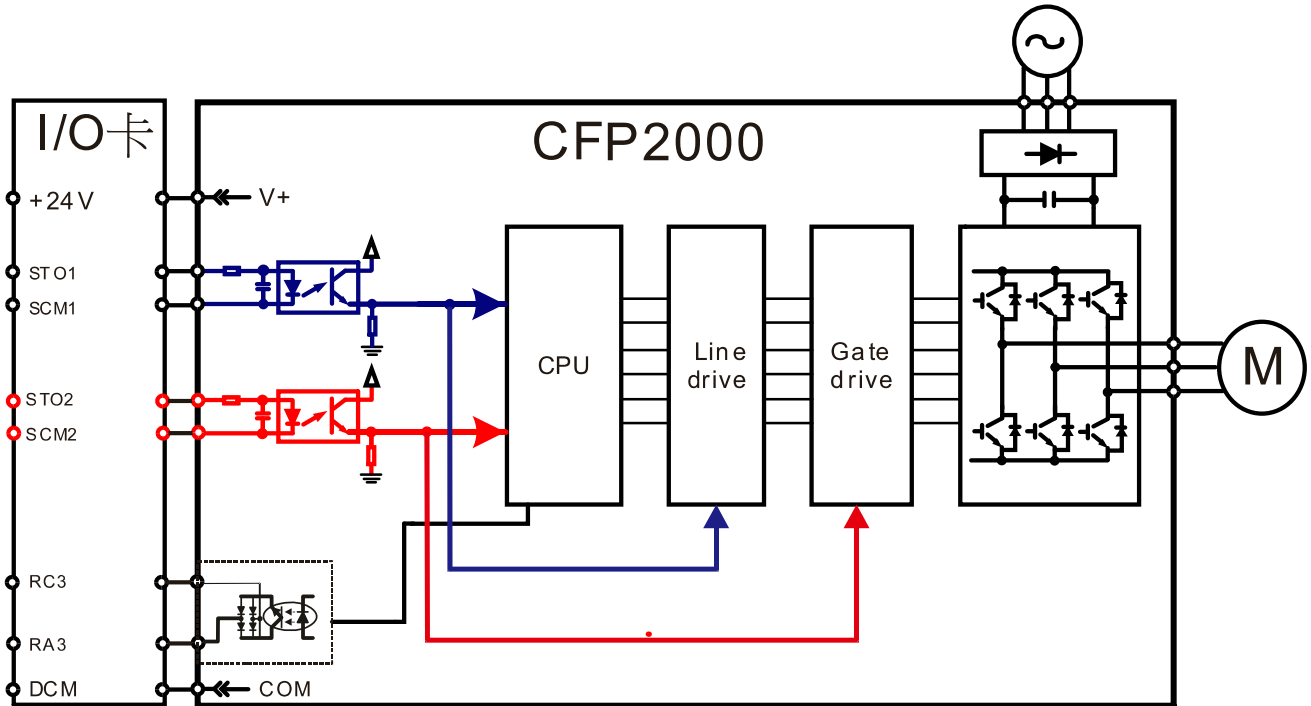

18-3-2 In the figure below, the factory setting for +24V-STO1-STO2 and SCM1-SCM2-DCM is short circuit:

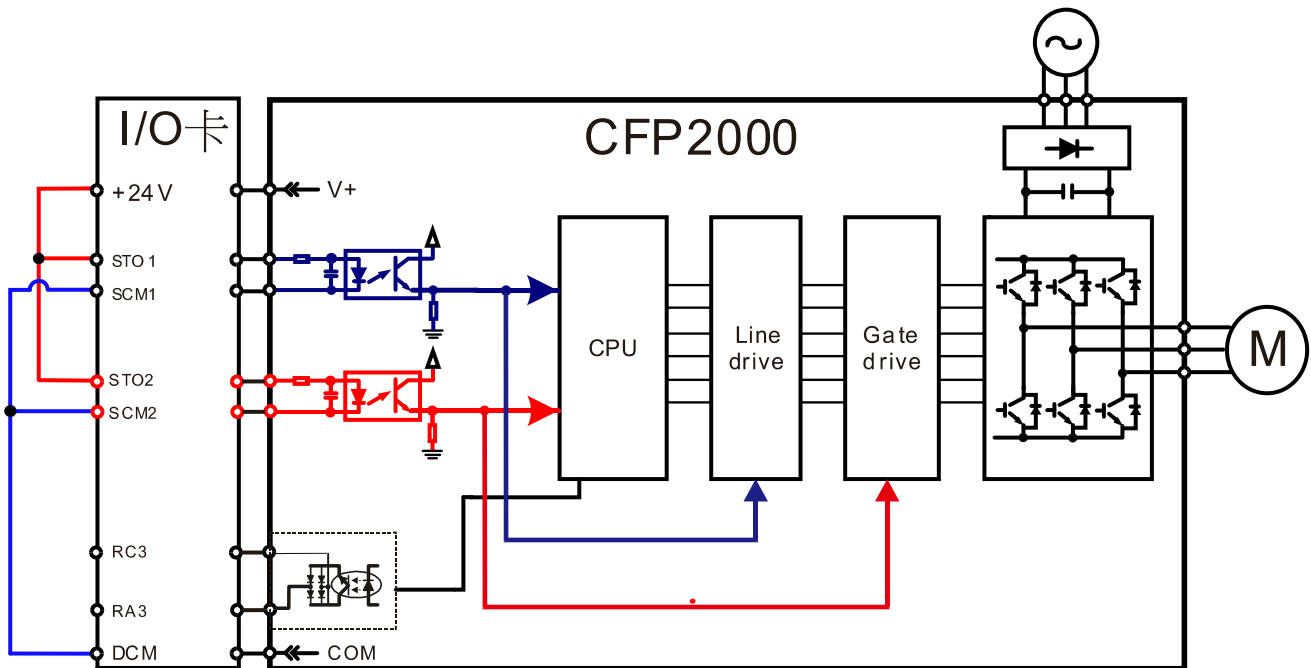

18-3-3 The control loop wiring diagram:

1. Remove the short-circuit of +24V-STO1-STO2 and DCM-SCM1-SCM2.
2. The wiring as below diagram. The ESTOP switch must at Close status in normal situation and drive will be able to Run.
3. STO mode, switch ESTOP open. Drive output stop and keypad display STO.

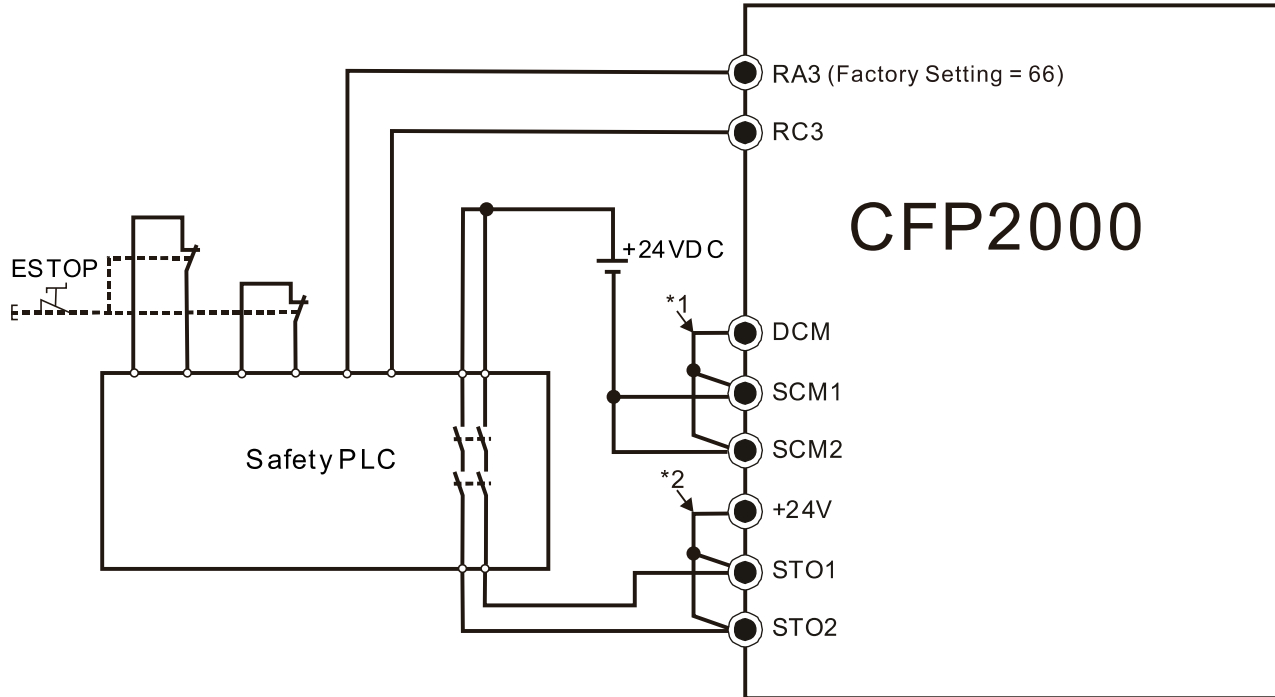

NOTE

- *1: Factory short circuit of DCM-SCM1-SCM2. To use the Safety function, please remove this short circuit.
- *2: Factory short circuit of +24V-STO1-STO2. To use the Safety function, please remove this short circuit.

18-4 Parameters

06-44 STO Alarm Latch

Factory setting: 0

Settings 0 : STO Alarm Latch
1 : STO Alarm no Latch

- 📖 Pr06-44=0 STO Alarm Latch: after the reason of STO Alarm is cleared, a Reset command is need to clear STO Alarm.
- 📖 Pr06-44=1 STO Alarm no Latch: after the reason of STO Alarm is cleared, the STO Alarm will be cleared automatically.
- 📖 All of STL1~STL3 error are "Alarm latch" mode (in STL1~STL3 mode, the Pr06-44 function is no effective).

02-13 Multi-function Output 1 (Relay1)

Factory Setting:11

02-14 Multi-function Output 2 (Relay2)

Factory Setting:1

02-15 Multi-function Output 3 (Relay3)

Factory Setting:66

Settings 66: SO N.O. output
68: SO N.C. output

Settings	Functions	Descriptions
66	SO Logic A output	Safety Output Normal Open
68	SO Logic B output	Safety Output Normal Close

- 📖 CFP2000 factory setting Pr02-15(Relay 3)=66(N.O.) and Multi-function Output setting item has added 2 new function: 66 and 68.

Drive status	Safety Output status	
	N.O. (MO=66)	N.C. (MO=68)
Normal run	Open	Close
STO	Close	Open
STL1~STL3	Close	Open

00-04 Content of Multi-function Display

Factory setting: 3

Settings 45: Hardware version

00-04=45	Hardware version
----------	------------------

18-5 Operating sequence description

18-5-1 Normal operation status

As shown in Figure 3: When the STO1~SCM1 and STO2~SCM2=ON (no STO function is need), the drive will execute "Operating" or "Output Stop" according to RUN/STOP command.

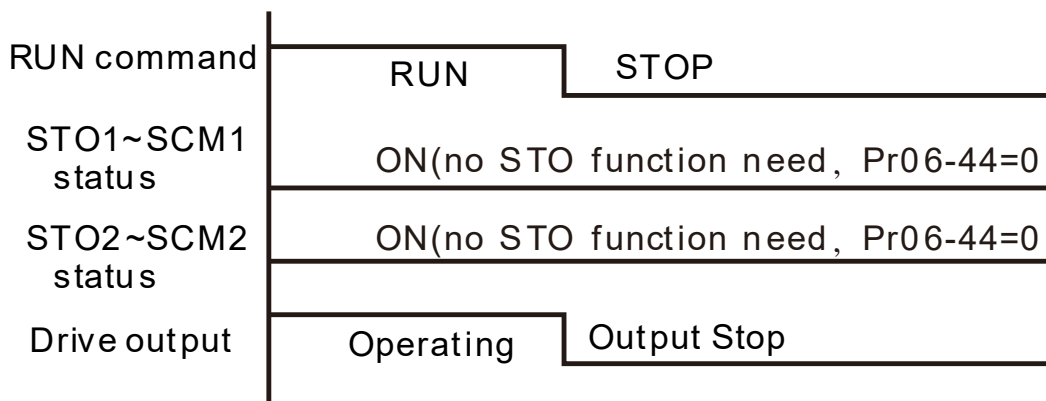

Figure 3

18-5-2-1 STO, Pr06-44=0, Pr02-35=0

As shown in Figure 4: When both of STO1~SCM1 and STO2~SCM2 channel has turn off during operating, the STO function enabling and the drive will stop output regardless of Run command is ON or OFF status.

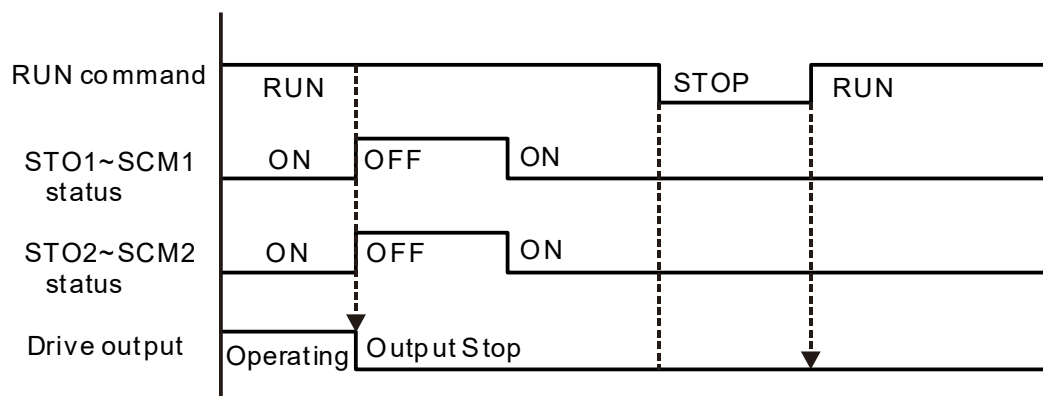

Figure 4

18-5-2-2 STO, Pr06-44=0, Pr02-35=1

As shown in Figure 5: As same as the figure 4. But, because the Pr02-35=1, therefore, after the Reset command, if the operating command still exists, then the drive will immediately execute the run command again.

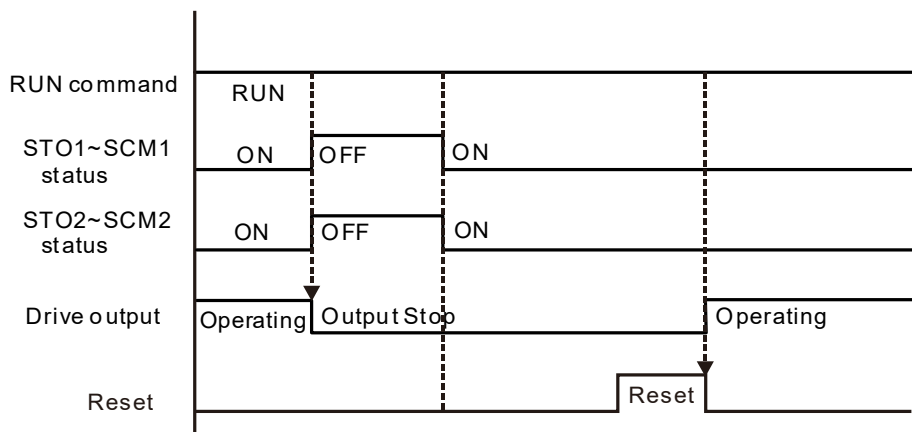

Figure 5

18-5-3 STO, Pr06-44=1, STO Alarm no latch

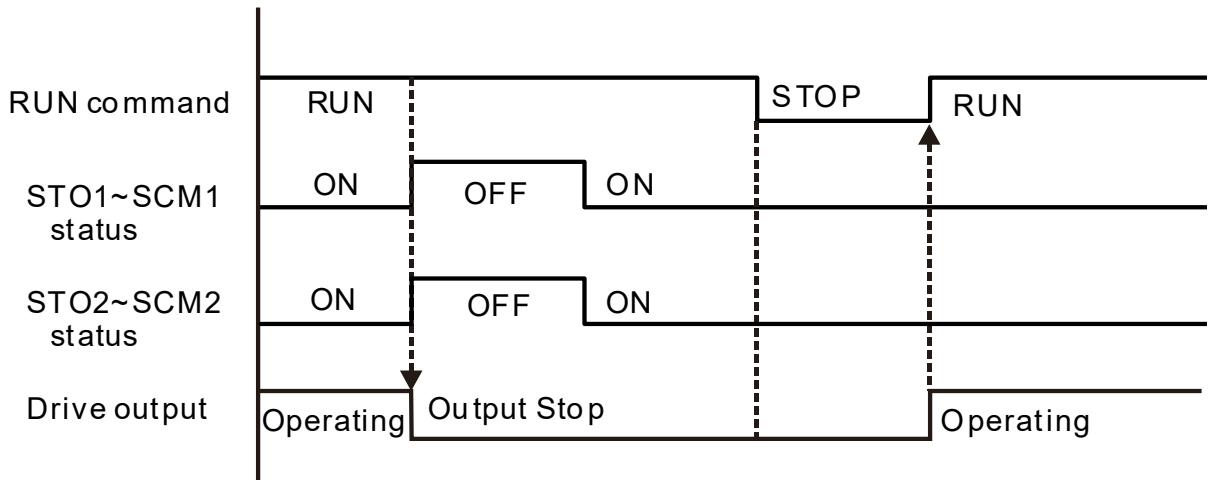

Figure 6

18-5-4 STL1

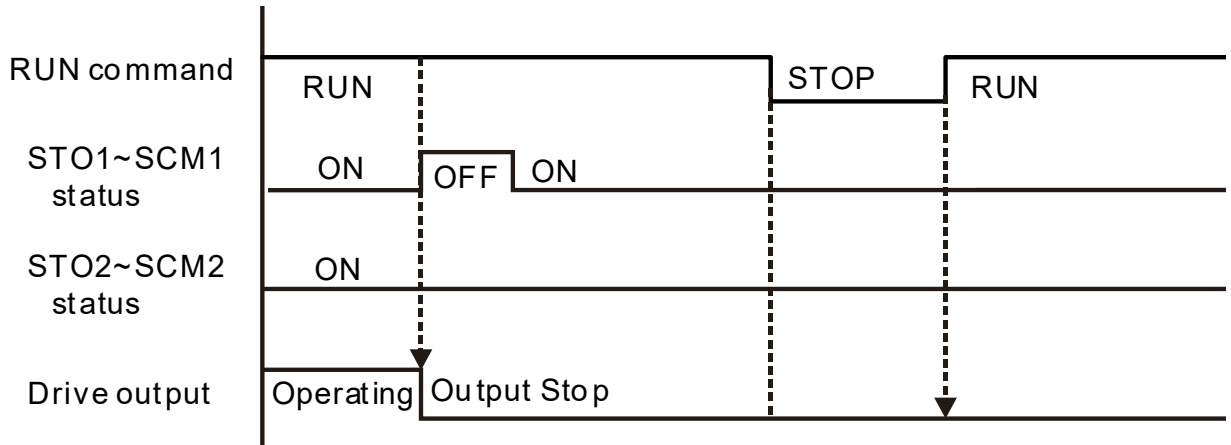

Figure 7

18-5-5 STL2

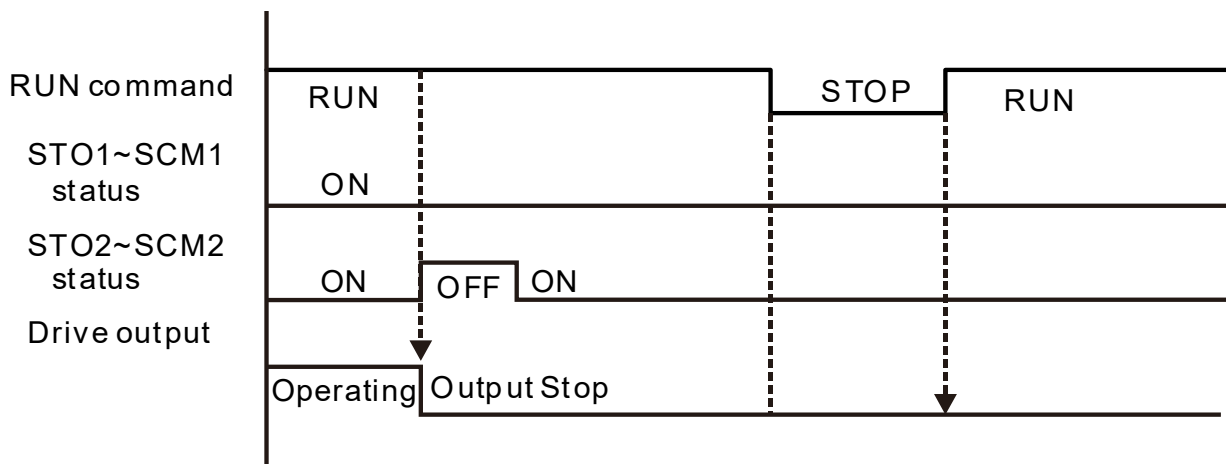

Figure 8

18-6 New Error code for STO function

06-17	Present Fault Record
06-18	Second Most Recent Fault Record
06-19	Third Most Recent Fault Record
06-20	Fourth Most Recent Fault Record
06-21	Fifth Most Recent Fault Record
06-22	Sixth Most Recent Fault Record

Settings 72 : Channel 1(STO1~SCM1) internal hardware error
 76 : STO(Safety Torque Off)
 77 : Channel 2(STO2~SCM2) internal hardware error
 78 : Channel 1 and Channel 2 internal hardware error

Error code	Name	Description
76	STO	Safe Torque Off function active
72	STL1 (STO1~SCM1)	STO1~SCM1 internal hardware detect error
77	STL2 (STO2~SCM2)	STO2~SCM2 internal hardware detect error
78	STL3	STO1~SCM1 and STO2~SCM2 internal hardware detect error

The Old/New control board and Old/New I/O card:

CFP2000	v1.12 firmware	v1.20 firmware
v1.12 control board + old I/O card(no STO function)	OK	OK
v1.12 control board + new I/O card(with STO function)	Error	Error
v1.20 control board + old I/O card(no STO function)	Error	Error
v1.20 control board + new I/O card(with STO function)	Error	OK

Appendix A. Publication History

If you need to contact the technical engineer of this product, please let them know the issue edition of this user manual and corresponded firmware version.

Issue Edition: V02

Firmware Version: V1.03

Issue Date: November, 2017

Explanations	Coverage
Add	
Add Apply After Service by Mobile Device	Chapter 1
Add notice of Mounting Clearance	Chapter 2
Add Specifications and Appearance of Brake Resistors, Installation of Brake Resistors and description of SCCR	Chapter 7
Add Specifications of external power card EMC-BPS01 and Delta Standard Fieldbus Cables	Chapter 8
Add Efficiency Curve, Voltage/ Current Derating Curve	Chapter 9
Add Adjustment and Application	Chapter 12-2
Add Chapter 17- Introduction to BACnet	Chapter 17
Add Chapter 18- Safe Torque Off function	Chapter 18
Revise	
Update Nameplate Information, Model Name, Serial Number, explanation of RFI Jumper and the hole dimension of Frame A-3, delete diagram 3 from situations must remove the RFI jumper	Chapter 1
Update notice of motor drive installation	Chapter 2
Update Wiring Diagram of all frames, and SINK(NPN)/SOURCE(PNP) diagram	Chapter 4
Update main circuit diagram Revise parameter description of Pr. 05-42 to "PM Motor Magnetic Angle"	Chapter 5
Update Digital Inputs wiring diagram, diagram of Removable Terminal Block and terminal circuit diagram.	Chapter 6
Revise terminals to AVI1, ACI & AVI2 Update its connected terminals (remove -10V Terminal) and corresponded setting range	Chapter 4 Chapter 6 Group 00 Parameters (00-04) Group 02 Parameters (02-31) Group 03 Parameters (03-03, 03-19, 03-23, 03-28,

Appendix A. Publication History | CFP2000

	03-52, 03-53, 03-54, 03-56, 03-62, 03-68) Group 06 Parameters (06-59) Group 09 Parameters (09-04) Group 13 Parameters (13-00) Chapter 15 Chapter 17
Update EMC filter list, AC input/output reactor spec. and corresponded Delta part number and drawing of fan	Chapter 7
Remove CANopen cables dimension & spec. chart and CANopen TAP dimension	Chapter 8
Update drawing of Installation/ Disconnection of external cards and terminal resistors	Chapter 8
Update description of General Specifications and Environment	Chapter 9
Delete quick settings of Keypad: VFPG, FOCPG and TQCPG	Chapter 10
Update settings and descriptions of Parameter: Parameter Group 00 (00-00, 00-17) Parameter Group 01 (01-24~01-27) Parameter Group 02 (02-33, 02-46, 02-54) Parameter Group 03 (03-19, 03-27) Parameter Group 05 (05-01, 05-04, 05-13, 05-16, 05-17) Parameter Group 06 (06-01, 06-31, 06-36, 06-52) Parameter Group 09 (09-41, 09-42) Parameter Group 10 (10-32, 10-42) Parameter Group 13 (13-01~13-99)	Chapter 11 Chapter 12
Change parameter description “Initial Angle Detection Pulse Level” and related explanations	Group 10 Parameters (10-42)